

Service Manual

Air-to-Water Hydromodule + Tank

Indoor Unit
WH-ADC1216G6E5

Outdoor Unit
WH-UX09FE5
WH-UX12FE5
WH-UD12FE5
WH-UD16FE5

Destination
Europe

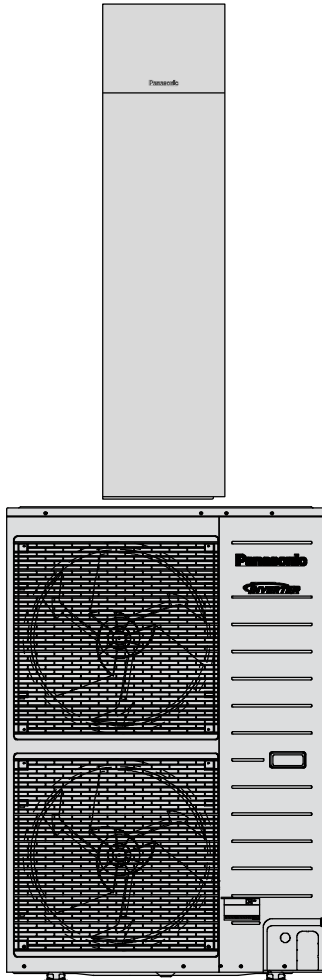

⚠ WARNING

This service information is designed for experienced repair technicians only and is not designed for use by the general public. It does not contain warnings or cautions to advise non-technical individuals of potential dangers in attempting to service a product. Products powered by electricity should be serviced or repaired only by experienced professional technicians. Any attempt to service or repair the products dealt with in this service information by anyone else could result in serious injury or death.

IMPORTANT SAFETY NOTICE

There are special components used in this equipment which are important for safety. These parts are marked by **⚠** in the Schematic Diagrams, Circuit Board Diagrams, Exploded Views and Replacement Parts List. It is essential that these critical parts should be replaced with manufacturer's specified parts to prevent shock, fire or other hazards. Do not modify the original design without permission of manufacturer.

⚠ PRECAUTION OF LOW TEMPERATURE



In order to avoid frostbite, be assured of no refrigerant leakage during the installation or repairing of refrigerant circuit.

TABLE OF CONTENTS

1. Safety Precautions	3	12.17 Three Ways Valve Control	75
2. Specifications	5	12.18 Two Ways Valve Control.....	76
2.1 WH-ADC1216G6E5 WH-UX09FE5	5	12.19 External OFF/ON Control	76
2.2 WH-ADC1216G6E5 WH-UX12FE5	8	12.20 Holiday Mode	77
2.3 WH-ADC1216G6E5 WH-UD12FE5.....	11	12.21 Dry Concrete Function.....	77
2.4 WH-ADC1216G6E5 WH-UD16FE5.....	14	13. Protection Control	78
3. Features	17	13.1 Protection Control for All Operations	78
4. Location of Controls and Components	18	13.2 Protection Control for Heating Operation.....	80
4.1 Indoor Unit	18	13.3 Protection Control for Cooling Operation.....	82
4.2 Outdoor Unit.....	27	14. Servicing Guide	83
5. Dimensions	28	14.1 Open and Close Top Front Plate	83
5.1 Indoor Unit	28	14.2 How to take out Bottom Front Plate.....	83
5.2 Outdoor Unit.....	29	14.3 Test Run	83
6. Refrigeration and Water Cycle Diagram	30	14.4 Proper Pump Down Procedure.....	84
7. Block Diagram	31	14.5 Adjust Water Flow Rate with Water Pump.....	84
7.1 WH-ADC1216G6E5 WH-UX09FE5 WH-ADC1619G6E5 WH-UX12FE5.....	31	14.6 Expansion Vessel Pre Pressure Checking	84
7.2 WH-ADC1216G6E5 WH-UD12FE5 WH-ADC1216G6E5 WH-UD16FE5.....	32	14.7 How to Unlock Cool Mode	85
8. Wiring Connection Diagram	33	14.8 Dry Concrete [SERVICE MODE: 03].....	85
8.1 Indoor Unit	33	14.9 EEPROM Factory Default Data Setup Procedure	85
8.2 Outdoor Unit.....	34	15. Maintenance Guide	86
9. Electronic Circuit Diagram	36	16. Troubleshooting Guide	89
9.1 Indoor Unit	36	16.1 Refrigeration Cycle System	89
9.2 Outdoor Unit.....	37	16.2 Relationship between the Condition of the Air-to-Water Hydromodule + Tank and Air-to- Water Heatpump Outdoor Units and Pressure and Electric Current	90
10. Printed Circuit Board	39	16.3 Breakdown Self Diagnosis Function	91
10.1 Indoor Unit	39	16.4 Error Codes Table.....	92
10.2 Outdoor Unit.....	40	16.5 Self-diagnosis Method	94
11. Installation Instruction	44	17. Disassembly and Assembly Instructions ...	134
11.1 Indoor Unit	44	17.1 To Remove Top Plate.....	134
11.2 Outdoor Unit.....	50	17.2 To Remove Pressure Gauge and Control Panel.....	135
12. Operation and Control	55	17.3 To Remove Bottom Front Plate	135
12.1 Basic Function	55	17.4 To Remove RCCB	136
12.2 Water Pump	66	17.5 To Remove Transformer and Electronic Controller	136
12.3 Pump Down Operation [Service Mode: 01].....	68	17.6 To Remove Pressure Relief Valve, Flow Switch and Air Purge Valve	137
12.4 Flow Switch.....	68	17.7 To Remove Water Pump	137
12.5 Indoor Unit Safety	69	17.8 To Remove Bottle Complete.....	138
12.6 Auto Restart Control	69	17.9 To Remove Anode Bar	138
12.7 Indication Panel	69	17.10 To Remove Water Filter.....	139
12.8 Indoor Back-Up Heater Control	70	18. Technical Data	140
12.9 Heater Control for Tank Side	71	18.1 Operation Characteristics	140
12.10 Base Pan Heater Control (Optional).....	71	18.2 Heating Capacity Table.....	164
12.11 Tank Pre-thermo OFF control.....	72	18.3 Cooling Capacity Table.....	165
12.12 Sterilization Mode	72	19. Exploded View and Replacement Parts List	166
12.13 Heating Outdoor Ambient Thermo OFF Control	73	19.1 Indoor Unit	166
12.14 Quiet Operation.....	73	19.2 Outdoor Unit.....	170
12.15 Anti Freeze Control.....	73		
12.16 External Room Thermostat Control (Optional)	74		

1. Safety Precautions















- Read the following “SAFETY PRECAUTIONS” carefully before perform any servicing.
- Electrical work must be installed or serviced by a licensed electrician. Be sure to use the correct rating and main circuit for the model installed.
- The caution items stated here must be followed because these important contents are related to safety. The meaning of each indication used is as below. Incorrect installation or servicing due to ignoring of the instruction will cause harm or damage, and the seriousness is classified by the following indications.

 WARNING	This indication shows the possibility of causing death or serious injury.
 CAUTION	This indication shows the possibility of causing injury or damage to properties.

- The items to be followed are classified by the symbols:

	This symbol denotes item that is PROHIBITED from doing.
---	---

- Carry out test run to confirm that no abnormality occurs after the servicing. Then, explain to user the operation, care and maintenance as stated in instructions. Please remind the customer to keep the operating instructions for future reference.

 WARNING	
1. Do not use unspecified cord, modified cord, joint cord or extension cord for power supply cord. Do not share the single outlet with other electrical appliances. Poor contact, poor insulation or over current will cause electrical shock or fire.	
2. Do not install outdoor unit near handrail of veranda. When installing outdoor unit at veranda of high rise building, child may climb up to outdoor unit and cross over the handrail and causing accident.	
3. Do not tie up the power supply cord into a bundle by band. Abnormal temperature rise on power supply cord may happen.	
4. Do not insert your fingers or other objects into the unit, high speed rotating fan may cause injury.  (For Outdoor Unit)	
5. Do not sit or step on the unit, you may fall down accidentally.  (For Outdoor Unit)	
6. Keep plastic bag (packaging material) away from small children, it may cling to nose and mouth and prevent breathing.	
7. Do not use pipe wrench to install refrigerant piping. It might deform the piping and cause the unit to malfunction.	
8. Do not purchase unauthorized electrical parts for installation, service, maintenance and etc.. They might cause electrical shock or fire.	
9. Do not modify the wiring of outdoor unit for installation of other components (i.e. heater, etc.). Overloaded wiring or wire connection points may cause electrical shock or fire. (For Outdoor Unit)	
10. Do not add or replace refrigerant other than specified type. It may cause product damage, burst and injury etc.	
11. Do not use the hot water produced by the Tank Unit for drinking or food preparation. It may cause illness to the user.	
12. Do not place containers with liquids on top of the Tank Unit. It may cause Tank Unit damage and/or fire could occurs if they leak or spill onto the Tank Unit.	
13. For electrical work, follow local wiring standard, regulation and this installation instruction. An independent circuit and single outlet must be used. If electrical circuit capacity is not enough or defect found in electrical work, it will cause electrical shock or fire.	
14. For water circuit installation work, follow to relevant European and national regulations (including EN61770) and local plumbing and building regulation codes. (For Tank Unit)	
15. Engage dealer or specialist for installation. If installation done by the user is defective, it will cause water leakage, electrical shock or fire.	
16. • This is a R410A model, when connecting the piping, do not use any existing (R22) pipes and flare nuts. Using such same may cause abnormally high pressure in the refrigeration cycle (piping), and possibly result in explosion and injury. Use only R410A refrigerant. • Thickness of copper pipes used with R410A must be 0.8 mm or more. Never use copper pipes thinner than 0.8 mm. • It is desirable that the amount of residual oil is less than 40 mg/10 m.	
17. When install or relocate Tank Unit / Outdoor Unit, do not let any substance other than the specified refrigerant, eg. air etc. mix into refrigerant cycle (piping). Mixing of air etc. will cause abnormal high pressure in refrigeration cycle and result in explosion, injury etc.	
18. Install according to this installation instructions strictly. If installation is defective, it will cause water leakage, electrical shock or fire.	
19. Install at a strong and firm location which is able to withstand the set's weight. If the strength is not enough or installation is not properly done, the set will drop and cause injury.	
20. Do not use joint cable for Tank Unit / Outdoor Unit connection cable. Use specified Tank Unit / Outdoor Unit connection cable, refer to instruction CONNECT THE CABLE TO THE TANK UNIT / CONNECT THE CABLE TO THE OUTDOOR UNIT and connect tightly for Tank Unit / Outdoor Unit connection. Clamp the cable so that no external force will be acted on the terminal. If connection or fixing is not perfect, it will cause heat up or fire at the connection.	
21. This equipment is strongly recommended to be installed with Residual Current Device (RCD) on-site according to the respective national wiring rules or country-specific safety measures in terms of residual current. (For Tank Unit)	
22. During installation, install the refrigerant piping properly before run the compressor. Operation of compressor without fixing refrigeration piping and valves at opened condition will cause suck-in of air, abnormal high pressure in refrigeration cycle and result in explosion, injury etc.	
23. During pump down operation, stop the compressor before remove the refrigeration piping. Removal of refrigerant piping while compressor is operating and valves are opened will cause suck-in of air, abnormal high pressure in refrigerant cycle and result in explosion, injury etc.	

 **WARNING**

24. Tighten the flare nut with torque wrench according to specified method. If the flare nut is over tightened, after a long period, the flare may break and cause refrigerant gas leakage.
25. After completion of installation, confirm there is no leakage of refrigerant gas. It may generate toxic gas when the refrigerant contacts with fire.
26. Ventilate the room if there is refrigerant gas leakage during operation. Extinguish all fire sources if present. It may cause toxic gas when the refrigerant contacts with fire.
27. Only use the supplied or specified installation parts, else, it may causes unit vibrate loose, water leakage, electrical shock or fire.
28. If there is any doubt about the installation procedure or operation, always contact the authorized dealer for advice and information.
29. Select a location where in case of water leakage, the leakage will not cause damage to other properties.
30. When installing electrical equipment at wooden building of metal lath or wire lath, in accordance with electrical facility standard, no electrical contact between equipment and building is allowed. Insulator must be installed in between.
31. Any work carried out on the Tank Unit / Outdoor Unit after removing any panels which is secured by screws, must be carried out under the supervision of authorized dealer and licensed installation contractor.
32. This system is multi supply appliance. All circuits must be disconnected before accessing the unit terminals. (For Tank Unit)
33. For cold water supply has a backflow regulator, check valve or water meter with check valve, provisions for thermal expansion of water in the hot water system must be provided. Otherwise it will cause water leakage. (For Tank Unit)
34. The piping installation work must be flushed before Tank Unit is connected to remove contaminants. Contaminants may damage the Tank Unit components.
35. This installation may be subjected to building regulation approval applicable to respective country that may require to notify the local authority before installation. (For Tank Unit)
36. The Tank Unit must be shipped and stored in upright condition and dry environment. It may laid on its back when being moved into the building.
37. Work done to the Tank Unit after remove the front plate cover that secured by screws, must be carried out under the supervision of authorized dealer, licensed installation contractor, skilled person and instructed person.
38. This unit must be properly earthed. The electrical earth must not be connected to a gas pipe, water pipe, the earth of lightning rod or a telephone. Otherwise there is a danger of electrical shock in the event of an insulation breakdown or electrical earth fault in the Tank Unit / Outdoor Unit.

 **CAUTION**

1. Do not install the Tank Unit / Outdoor Unit at place where leakage of flammable gas may occur. In case gas leaks and accumulates at surrounding of the unit, it may cause fire. ⊘
2. Do not release refrigerant during piping work for installation, re-installation and during repairing a refrigeration parts. Take care of the liquid refrigerant, it may cause frostbite. ⊘
3. Do not install this appliance in a laundry room or other high humidity location. This condition will cause rust and damage to the unit. (For Tank Unit) ⊘
4. Make sure the insulation of power supply cord does not contact hot part (i.e. refrigerant piping, water piping) to prevent from insulation failure (melt). ⊘
5. Do not apply excessive force to water pipes that may damage the pipes. If water leakage occurs, it will cause flooding and damage to other properties. (For Tank Unit) ⊘
6. Do not transport the Tank Unit with water inside the unit. It may cause damage to the unit. ⊘
7. Carry out drainage piping as mentioned in installation instructions. If drainage is not perfect, water may enter the room and damage the furniture. (For Tank Unit)
8. Do not touch the sharp aluminium fin, sharp parts may cause injury.  (For Outdoor Unit) ⊘
9. Select an installation location which is easy for maintenance.
10. Power supply connection to Tank Unit.
 - Power supply point should be in easily accessible place for power disconnection in case of emergency.
 - Must follow local national wiring standard, regulation and this installation instruction.
 - Strongly recommended to make permanent connection to a circuit breaker.
 - Power Supply 1: Use approved 30A 2-poles circuit breaker with a minimum contact gap of 3.0mm.
 - Power Supply 2: Use approved 30A 2-poles circuit breaker with a minimum contact gap of 3.0mm.
11. Ensure the correct polarity is maintained throughout all wiring. Otherwise, it will cause electrical shock or fire.
12. After installation, check the water leakage condition in connection area during test run. If leakage occurs, it will cause damage to other properties. (For Tank Unit)
13. If the Tank Unit not operates for long time, the water inside the Tank Unit should be drained.
14. Installation work.
 - It may need three or more people to carry out the installation work. The weight of Tank Unit might cause injury if carried by one person.
 - It may need two or more people to carry out the installation work. The weight of outdoor unit might cause injury if carried by one person.

2. Specifications

2.1 WH-ADC1216G6E5 WH-UX09FE5

Item		Unit	Outdoor Unit		
Performance Test Condition			EN 14511		
Cooling Capacity	Condition (Ambient/Water)		A35W7		
	kW		7.00		
	BTU/h		23900		
	kcal/h		6020		
Cooling EER	W/W		3.17		
	kcal/hW		2.72		
Heating Capacity	Condition (Ambient/Water)		A7W35	A2W35	
	kW		9.00	9.00	
	BTU/h		30700	30700	
	kcal/h		7740	7740	
Heating COP	W/W		4.84	3.59	
	kcal/hW		3.16	3.08	
Noise Level	Condition (Ambient/Water)		A35W7	A7W35	A2W35
	dB (A)		Cooling: 49	Heating: 49	—
	Power Level dB		Cooling: 67	Heating: 66	—
Air Flow	m ³ /min (ft ³ /min)		Cooling: 89.5 (3160) Heating: 76.8 (2710)		
Refrigeration Control Device			Expansion Valve		
Refrigeration Oil		cm ³	FV50S (1200)		
Refrigerant (R410A)		kg (oz)	2.85 (100.6)		
Dimension	Height	mm (inch)	1340 (52-3/4)		
	Width	mm (inch)	900 (35-7/16)		
	Depth	mm (inch)	320 (12-19/32)		
Net Weight		kg (lbs)	101 (223)		
Pipe Diameter	Liquid	mm (inch)	9.52 (3/8)		
	Gas	mm (inch)	15.88 (5/8)		
Standard Length		m (ft)	5 (16.4)		
Pipe Length Range		m (ft)	3 (9.8) ~ 30 (98.4)		
I/D & O/D Height Difference		m (ft)	20 (65.6)		
Additional Gas Amount		g/m (oz/ft)	50 (0.5)		
Refrigeration Charge Less		m (ft)	10 (32.8)		
Compressor	Type		Hermetic Motor		
	Motor Type		Brushless (4-poles)		
	Rated Output	kW	3.00		
Fan	Type		Propeller Fan		
	Material		PP		
	Motor Type		DC (8-poles)		
	Input Power	W	—		
	Output Power	W	60		
	Fan Speed	rpm	Cooling: 550 (Top), 590 (Bottom) Heating: 490 (Top), 530 (Bottom)		
Heat Exchanger	Fin material		Aluminium (Pre Coat)		
	Fin Type		Corrugated Fin		
	Row × Stage × FPI		2 × 51 × 18		
	Size (W × H × L)	mm	903.7 × 1295.4 × 38.1		

Item		Unit	Outdoor Unit		
Power Source (Phase, Voltage, Cycle)		∅	Single		
		V	230		
		Hz	50		
Input Power		Condition (Ambient/Water)	A35W7	A7W35	A2W35
		kW	Cooling: 2.21	Heating: 1.86	Heating: 2.51
Maximum Input Power For Heatpump System		kW	5.41		
Power Supply 1 : Phase (∅) / Max. Current (A) / Max. Input Power (W)			1∅ / 25.0 / 5.41k		
Power Supply 2 : Phase (∅) / Max. Current (A) / Max. Input Power (W)			1∅ / 26.0 / 6.00k		
Power Supply 3 : Phase (∅) / Max. Current (A) / Max. Input Power (W)			— / — / —		
Starting Current		A	10.2		
Running Current		Condition (Ambient/Water)	A35W7	A7W35	A2W35
		A	Cooling: 10.2	Heating: 8.6	Heating: 11.6
Maximum Current For Heatpump System		A	25.0		
Power Factor Power factor means total figure of compressor and outdoor fan motor.		%	Cooling: 94 Heating: 94		
Power Cord	Number of core		-		
	Length	m (ft)	-		
Thermostat			Electronic Control		
Protection Device			Electronic Control		

Item		Unit	Indoor Unit		
Performance Test Condition			EN 14511		
Operation Range		Outdoor Ambient	°C (min. / max.) Cooling: 16 / 43 Heating: -20 / 35		
		Water Outlet	°C (min. / max.) Cooling: 5 / 20 Heating (Tank): - / 65*, Heating (Circuit): 25 / 55		
Internal Pressure Differential		kPa	Cooling: 20.0 Heating: 31.0		
Noise Level		Condition (Ambient/Water)	A35W7	A7W35	A2W35
		dB (A)	Cooling: 33	Heating: 33	—
		Power Level dB	Cooling: 46	Heating: 46	—
Dimension		Height	mm (inch) 717 (28-7/32)		
		Width	mm (inch) 598 (23-17/32)		
		Depth	mm (inch) 1800 (70-27/32)		
Net Weight		kg (lbs)	137 (302)		
Refrigerant Pipe Diameter		Liquid	mm (inch) 9.52 (3/8)		
		Gas	mm (inch) 15.88 (5/8)		
Water Pipe Diameter		Room	mm (inch) 28 (1-3/32)		
		Shower	mm (inch) 19 (3/4)		
Water Drain Hose Inner Diameter		mm (inch)	15 (19/32)		
Pump		Motor Type	DC Motor		
		No. of Speed	7 (Software Selection)		
		Input Power	W	93	
Hot Water Coil		Type	Brazen Plate		
		No. of Plates	44		
		Size (H x W x L)	mm 80 x 119 x 376		
		Water Flow Rate	l/min (m ³ /h) Cooling: 20.1 (1.2) Heating: 25.8 (1.5)		
Pressure Relief Valve Water Circuit		kPa	Open: 300, Close: 265 and below		
Flow Switch		Type	Magnetic Lead Switch		
		Set Point	l/min	11.1	
Pressure Release Valve		kPa	Open: 1150±200, Close: 700 and below		
Protection Device		A	Residual Current Circuit Breaker (30)		

Item		Unit	Indoor Unit
Expansion Vessel	Volume	l	10
	MWP	bar	3
Capacity of Integrated Electric Heater / OLP TEMP		kW / °C	6.00 / 80
Tank Volume (Spec / Nett)		L	200 / 185
Max. Tank Water Set Temperature		°C	65
Tank Coil Surface		m ²	1.8
Maximum Working Pressure	Heat / Cool	Bar	3.0
	Tank Circuit	Bar	10.0
Operating Pressure	Tank Unit	Bar	3.5
	Expansion Relief Valve	Bar	8.0
Expansion Vessel Pre-charge Pressure (DHW Circuit)		Bar	3.5
Pressure Reducing Valve Set Pressure (DHW Circuit)		Bar	3.5
Pressure Vessel	Material		EN-1.4521
	Volume	L	185
	Design Pressure	Bar	10
Heat Exchanger	Material		EN-1.4162 / EN-1.4521
	Diameter	mm	22
	Thickness	mm	0.8
	Surface Area	m ²	1.8
	Total Length	m	25
Anode	Material		Aluminium
	Diameter	mm	20
	Length	mm	1000

Note:

- Cooling capacities are based on outdoor air temperature of 35°C Dry Bulb with controlled indoor water inlet temperature of 12°C and water outlet temperature of 7°C.
- Heating capacities are based on outdoor air temperature of 7°C Dry Bulb (44.6°F Dry Bulb), 6°C Wet Bulb (42.8°F Wet Bulb) with controlled indoor water inlet temperature of 30°C and water outlet temperature of 35°C.
- Specifications are subjected to change without prior notice for further improvement.
- * Above 55°C, only possible with backup heater operation.

2.2 WH-ADC1216G6E5 WH-UX12FE5

Item		Unit	Outdoor Unit		
Performance Test Condition			EN 14511		
Cooling Capacity	Condition (Ambient/Water)		A35W7		
	kW		10.00		
	BTU/h		34100		
	kcal/h		8600		
Cooling EER	W/W		2.81		
	kcal/hW		2.42		
Heating Capacity	Condition (Ambient/Water)		A7W35	A2W35	
	kW		12.00	12.00	
	BTU/h		41000	41000	
	kcal/h		10320	10320	
Heating COP	W/W		4.74	3.44	
	kcal/hW		4.08	2.96	
Noise Level	Condition (Ambient/Water)		A35W7	A7W35	A2W35
	dB (A)		Cooling: 50	Heating: 50	—
	Power Level dB		Cooling: 68	Heating: 67	—
Air Flow	m ³ /min (ft ³ /min)		Cooling: 93.3 (3290) Heating: 80.0 (2830)		
Refrigeration Control Device			Expansion Valve		
Refrigeration Oil		cm ³	FV50S (1200)		
Refrigerant (R410A)		kg (oz)	2.85k (100.6)		
Dimension	Height	mm (inch)	1340 (52-3/4)		
	Width	mm (inch)	900 (35-7/16)		
	Depth	mm (inch)	320 (12-19/32)		
Net Weight		kg (lbs)	101 (223)		
Pipe Diameter	Liquid	mm (inch)	9.52 (3/8)		
	Gas	mm (inch)	15.88 (5/8)		
Standard Length		m (ft)	5 (16.4)		
Pipe Length Range		m (ft)	3 (9.8) ~ 30 (98.4)		
I/D & O/D Height Difference		m (ft)	20 (65.6)		
Additional Gas Amount		g/m (oz/ft)	50 (0.5)		
Refrigeration Charge Less		m (ft)	10 (32.8)		
Compressor	Type		Hermetic Motor		
	Motor Type		Brushless (4-poles)		
	Rated Output	kW	3.00		
Fan	Type		Propeller Fan		
	Material		PP		
	Motor Type		DC (8-poles)		
	Input Power	W	—		
	Output Power	W	60		
	Fan Speed	rpm	Cooling: 600 (Top), 640 (Bottom) Heating: 520 (Top), 560 (Bottom)		
Heat Exchanger	Fin material		Aluminium (Pre Coat)		
	Fin Type		Corrugated Fin		
	Row × Stage × FPI		2 × 51 × 18		
	Size (W × H × L)	mm	903.7 × 1295.4 × 38.1		

Item		Unit	Outdoor Unit		
Power Source (Phase, Voltage, Cycle)		ø	Single		
		V	230		
		Hz	50		
Input Power		Condition (Ambient/Water)	A35W7	A7W35	A2W35
		kW	Cooling: 3.56	Heating: 2.53	Heating: 3.49
Maximum Input Power For Heatpump System		kW	6.27		
Power Supply 1 : Phase (Ø) / Max. Current (A) / Max. Input Power (W)		1Ø / 29.0 / 6.27k			
Power Supply 2 : Phase (Ø) / Max. Current (A) / Max. Input Power (W)		1Ø / 26.0 / 6.00k			
Power Supply 3 : Phase (Ø) / Max. Current (A) / Max. Input Power (W)		— / — / —			
Starting Current		A	16.5		
Running Current		Condition (Ambient/Water)	A35W7	A7W35	A2W35
		A	Cooling: 16.5	Heating: 11.7	Heating: 16.1
Maximum Current For Heatpump System		A	29.0		
Power Factor Power factor means total figure of compressor and outdoor fan motor.		%	Cooling: 94 Heating: 94		
Power Cord	Number of core		-		
	Length	m (ft)	-		
Thermostat			Electronic Control		
Protection Device			Electronic Control		

Item		Unit	Indoor Unit		
Performance Test Condition			EN 14511		
Operation Range	Outdoor Ambient	°C (min. / max.)	Cooling: 16 / 43 Heating: -20 / 35		
	Water Outlet	°C (min. / max.)	Cooling: 5 / 20 Heating (Tank): - / 65°, Heating (Circuit): 25 / 55		
Internal Pressure Differential		kPa	Cooling: 38.0 Heating: 52.5		
Noise Level		Condition (Ambient/Water)	A35W7	A7W35	A2W35
		dB (A)	Cooling: 33	Cooling: 33	—
		Power Level dB	Cooling: 46	Cooling: 46	—
Dimension	Height	mm (inch)	717 (28-7/32)		
	Width	mm (inch)	598 (23-17/32)		
	Depth	mm (inch)	1800 (70-27/32)		
Net Weight		kg (lbs)	137 (302)		
Refrigerant Pipe Diameter	Liquid	mm (inch)	9.52 (3/8)		
	Gas	mm (inch)	15.88 (5/8)		
Water Pipe Diameter	Room	mm (inch)	28 (1-3/32)		
	Shower	mm (inch)	19 (3/4)		
Water Drain Hose Inner Diameter		mm (inch)	15 (19/32)		
Pump	Motor Type		DC Motor		
	No. of Speed		7 (Software Selection)		
	Input Power	W	97		
Hot Water Coil	Type		Brazen Plate		
	No. of Plates		44		
	Size (H x W x L)	mm	80 x 119 x 376		
	Water Flow Rate	l/min (m ³ /h)	Cooling: 28.7 (1.7) Heating: 34.4 (2.1)		
Pressure Relief Valve Water Circuit		kPa	Open: 300, Close: 265 and below		
Flow Switch	Type		Magnetic Lead Switch		
	Set Point	l/min	11.1		
Pressure Release Valve		kPa	Open: 1150±200, Close: 700 and below		

Item		Unit	Indoor Unit
Protection Device		A	Residual Current Circuit Breaker (30)
Expansion Vessel	Volume	l	10
	MWP	bar	3
Capacity of Integrated Electric Heater / OLP TEMP		kW / °C	6.00 / 80
Tank Volume (Spec / Nett)		L	200 / 185
Max. Tank Water Set Temperature		°C	65
Tank Coil Surface		m ²	1.8
Maximum Working Pressure	Heat / Cool	Bar	3.0
	Tank Circuit	Bar	10.0
Operating Pressure	Tank Unit	Bar	3.5
	Expansion Relief Valve	Bar	8.0
Expansion Vessel Pre-charge Pressure (DHW Circuit)		Bar	3.5
Pressure Reducing Valve Set Pressure (DHW Circuit)		Bar	3.5
Pressure Vessel	Material		En-1.4521
	Volume	L	185
	Design Pressure	Bar	10
Heat Exchanger	Material		EN-1.4162 / EN-1.4521
	Diameter	mm	22
	Thickness	mm	0.8
	Surface Area	m ²	1.8
	Total Length	m	25
Anode	Material		Aluminium
	Diameter	mm	20
	Length	mm	1000

Note:

- Cooling capacities are based on outdoor air temperature of 35°C Dry Bulb with controlled indoor water inlet temperature of 12°C and water outlet temperature of 7°C.
- Heating capacities are based on outdoor air temperature of 7°C Dry Bulb (44.6°F Dry Bulb), 6°C Wet Bulb (42.8°F Wet Bulb) with controlled indoor water inlet temperature of 30°C and water outlet temperature of 35°C.
- Specifications are subjected to change without prior notice for further improvement.
- * Above 55°C, only possible with backup heater operation.

2.3 WH-ADC1216G6E5 WH-UD12FE5

Item		Unit	Outdoor Unit		
Performance Test Condition			EN 14511		
Cooling Capacity	Condition (Ambient/Water)		A35W7		
	kW		10.00		
	BTU/h		34100		
	kcal/h		8600		
Cooling EER	W/W		2.81		
	kcal/hW		2.42		
Heating Capacity	Condition (Ambient/Water)		A7W35	A2W35	
	kW		12.00	11.40	
	BTU/h		41000	38900	
	kcal/h		10320	9800	
Heating COP	W/W		4.74	3.44	
	kcal/hW		4.08	2.96	
Noise Level	Condition (Ambient/Water)		A35W7	A7W35	A2W35
	dB (A)		Cooling: 50	Heating: 50	—
	Power Level dB		Cooling: 68	Heating: 67	—
Air Flow	m ³ /min (ft ³ /min)		Cooling: 93.3 (3290) Heating: 80.0 (2830)		
Refrigeration Control Device			Expansion Valve		
Refrigeration Oil		cm ³	FV50S (1200)		
Refrigerant (R410A)		kg (oz)	2.55 (90.0)		
Dimension	Height	mm (inch)	1340 (52-3/4)		
	Width	mm (inch)	900 (35-7/16)		
	Depth	mm (inch)	320 (12-19/32)		
Net Weight		kg (lbs)	101 (223)		
Pipe Diameter	Liquid	mm (inch)	9.52 (3/8)		
	Gas	mm (inch)	15.88 (5/8)		
Standard Length		m (ft)	5 (16.4)		
Pipe Length Range		m (ft)	3 (9.8) ~ 30 (98.4)		
I/D & O/D Height Difference		m (ft)	20 (65.6)		
Additional Gas Amount		g/m (oz/ft)	50 (0.5)		
Refrigeration Charge Less		m (ft)	10 (32.8)		
Compressor	Type		Hermetic Motor		
	Motor Type		Brushless (4-poles)		
	Rated Output	kW	3.00		
Fan	Type		Propeller Fan		
	Material		PP		
	Motor Type		DC (8-poles)		
	Input Power	W	—		
	Output Power	W	60		
	Fan Speed	rpm	Cooling: 600 (Top), 640 (Bottom) Heating: 510 (Top), 550 (Bottom)		
Heat Exchanger	Fin material		Aluminium (Pre Coat)		
	Fin Type		Corrugated Fin		
	Row × Stage × FPI		2 × 51 × 18		
	Size (W × H × L)	mm	903.7 × 1290.1 × 38.1		

Item		Unit	Outdoor Unit		
Power Source (Phase, Voltage, Cycle)		∅	Single		
		V	230		
		Hz	50		
Input Power		Condition (Ambient/Water)	A35W7	A7W35	A2W35
		kW	Cooling: 3.56	Heating: 2.53	Heating: 3.31
Maximum Input Power For Heatpump System		kW	5.30		
Power Supply 1 : Phase (∅) / Max. Current (A) / Max. Input Power (W)			1∅ / 24.0 / 5.30k		
Power Supply 2 : Phase (∅) / Max. Current (A) / Max. Input Power (W)			1∅ / 26.0 / 6.00k		
Power Supply 3 : Phase (∅) / Max. Current (A) / Max. Input Power (W)			— / — / —		
Starting Current		A	16.0		
Running Current		Condition (Ambient/Water)	A35W7	A7W35	A2W35
		A	Cooling: 16.0	Heating: 11.5	Heating: 15.0
Maximum Current For Heatpump System		A	24.0		
Power Factor Power factor means total figure of compressor and outdoor fan motor.		%	Cooling: 97 Heating: 96		
Power Cord	Number of core		-		
	Length	m (ft)	-		
Thermostat			Electronic Control		
Protection Device			Electronic Control		

Item		Unit	Indoor Unit		
Performance Test Condition			EN 14511		
Operation Range		Outdoor Ambient	°C (min. / max.) Cooling: 16 / 43 Heating: -20 / 35		
		Water Outlet	°C (min. / max.) Cooling: 5 / 20 Heating (Tank): - / 65*, Heating (Circuit): 25 / 55		
Internal Pressure Differential		kPa	Cooling: 38.0 Heating: 52.5		
Noise Level		Condition (Ambient/Water)	A35W7	A7W35	A2W35
		dB (A)	Cooling: 33	Cooling: 33	—
		Power Level dB	Cooling: 46	Cooling: 46	—
Dimension		Height	mm (inch) 717 (28-7/32)		
		Width	mm (inch) 598 (23-17/32)		
		Depth	mm (inch) 1800 (70-27/32)		
Net Weight		kg (lbs)	137 (302)		
Refrigerant Pipe Diameter		Liquid	mm (inch) 9.52 (3/8)		
		Gas	mm (inch) 15.88 (5/8)		
Water Pipe Diameter		Room	mm (inch) 28 (1-3/32)		
		Shower	mm (inch) 19 (3/4)		
Water Drain Hose Inner Diameter		mm (inch)	15 (19/32)		
Pump		Motor Type	DC Motor		
		No. of Speed	7 (Software Selection)		
		Input Power	W	97	
Hot Water Coil		Type	Brazen Plate		
		No. of Plates	44		
		Size (H x W x L)	mm 80 x 119 x 376		
		Water Flow Rate	l/min (m ³ /h) Cooling: 28.7 (1.7) Heating: 34.4 (2.1)		
Pressure Relief Valve Water Circuit		kPa	Open: 300, Close: 265 and below		
Flow Switch		Type	Magnetic Lead Switch		
		Set Point	l/min	11.1	
Pressure Release Valve		kPa	Open: 1150±200, Close: 700 and below		

Item		Unit	Indoor Unit
Protection Device		A	Residual Current Circuit Breaker (30)
Expansion Vessel	Volume	l	10
	MWP	bar	3
Capacity of Integrated Electric Heater / OLP TEMP		kW / °C	6.00 / 80
Tank Volume (Spec / Nett)		L	200 / 185
Max. Tank Water Set Temperature		°C	65
Tank Coil Surface		m ²	1.8
Maximum Working Pressure	Heat / Cool	Bar	3.0
	Tank Circuit	Bar	10.0
Operating Pressure	Tank Unit	Bar	3.5
	Expansion Relief Valve	Bar	8.0
Expansion Vessel Pre-charge Pressure (DHW Circuit)		Bar	3.5
Pressure Reducing Valve Set Pressure (DHW Circuit)		Bar	3.5
Pressure Vessel	Material		En-1.4521
	Volume	L	185
	Design Pressure	Bar	10
Heat Exchanger	Material		EN-1.4162 / EN-1.4521
	Diameter	mm	22
	Thickness	mm	0.8
	Surface Area	m ²	1.8
	Total Length	m	25
Anode	Material		Aluminium
	Diameter	mm	20
	Length	mm	1000

Note:

- Cooling capacities are based on outdoor air temperature of 35°C Dry Bulb with controlled indoor water inlet temperature of 12°C and water outlet temperature of 7°C.
- Heating capacities are based on outdoor air temperature of 7°C Dry Bulb (44.6°F Dry Bulb), 6°C Wet Bulb (42.8°F Wet Bulb) with controlled indoor water inlet temperature of 30°C and water outlet temperature of 35°C.
- Specifications are subjected to change without prior notice for further improvement.
- * Above 55°C, only possible with backup heater operation.

2.4 WH-ADC1216G6E5 WH-UD16FE5

Item		Unit	Outdoor Unit		
Performance Test Condition			EN 14511		
Cooling Capacity	Condition (Ambient/Water)		A35W7		
	kW		12.20		
	BTU/h		41600		
	kcal/h		10490		
Cooling EER	W/W		2.56		
	kcal/hW		2.20		
Heating Capacity	Condition (Ambient/Water)		A7W35	A2W35	
	kW		16.00	13.00	
	BTU/h		54600	44300	
	kcal/h		13760	11180	
Heating COP	W/W		4.28	3.28	
	kcal/hW		3.68	2.82	
Noise Level	Condition (Ambient/Water)		A35W7	A7W35	A2W35
	dB (A)		Cooling: 54	Heating: 53	—
	Power Level dB		Cooling: 72	Heating: 70	—
Air Flow	m ³ /min (ft ³ /min)		Cooling: 97.8 (3450) Heating: 90.0 (3180)		
Refrigeration Control Device			Expansion Valve		
Refrigeration Oil		cm ³	FV50S (1200)		
Refrigerant (R410A)		kg (oz)	2.55 (90.0)		
Dimension	Height	mm (inch)	1340 (52-3/4)		
	Width	mm (inch)	900 (35-7/16)		
	Depth	mm (inch)	320 (12-19/32)		
Net Weight		kg (lbs)	150 (331)		
Pipe Diameter	Liquid	mm (inch)	9.52 (3/8)		
	Gas	mm (inch)	15.88 (5/8)		
Standard Length		m (ft)	5 (16.4)		
Pipe Length Range		m (ft)	3 (9.8) ~ 30 (98.4)		
I/D & O/D Height Difference		m (ft)	20 (65.6)		
Additional Gas Amount		g/m (oz/ft)	50 (0.5)		
Refrigeration Charge Less		m (ft)	10 (32.8)		
Compressor	Type		Hermetic Motor		
	Motor Type		Brushless (4-poles)		
	Rated Output	kW	3.00		
Fan	Type		Propeller Fan		
	Material		PP		
	Motor Type		DC (8-poles)		
	Input Power	W	—		
	Output Power	W	60		
	Fan Speed	rpm	Cooling: 630 (Top), 670 (Bottom) Heating: 580 (Top), 620 (Bottom)		
Heat Exchanger	Fin material		Aluminium (Pre Coat)		
	Fin Type		Corrugated Fin		
	Row × Stage × FPI		2 × 51 × 18		
	Size (W × H × L)	mm	903.7 × 1290.1 × 38.1		

Item		Unit	Outdoor Unit		
Power Source (Phase, Voltage, Cycle)		ø	Single		
		V	230		
		Hz	50		
Input Power		Condition (Ambient/Water)	A35W7	A7W35	A2W35
		kW	Cooling: 4.76	Heating: 3.74	Heating: 3.96
Maximum Input Power For Heatpump System		kW	5.74		
Power Supply 1 : Phase (Ø) / Max. Current (A) / Max. Input Power (W)		1Ø / 26.0 / 5.74k			
Power Supply 2 : Phase (Ø) / Max. Current (A) / Max. Input Power (W)		1Ø / 26.0 / 6.00k			
Power Supply 3 : Phase (Ø) / Max. Current (A) / Max. Input Power (W)		— / — / —			
Starting Current		A	21.3		
Running Current		Condition (Ambient/Water)	A35W7	A7W35	A2W35
		A	Cooling: 21.3	Heating: 16.9	Heating: 17.9
Maximum Current For Heatpump System		A	26.0		
Power Factor Power factor means total figure of compressor and outdoor fan motor.		%	Cooling: 97 Heating: 96		
Power Cord	Number of core		-		
	Length	m (ft)	-		
Thermostat			Electronic Control		
Protection Device			Electronic Control		

Item		Unit	Indoor Unit		
Performance Test Condition			EN 14511		
Operation Range	Outdoor Ambient	°C (min. / max.)	Cooling: 16 / 43 Heating: -20 / 35		
	Water Outlet	°C (min. / max.)	Cooling: 5 / 20 Heating (Tank): - / 65°, Heating (Circuit): 25 / 55		
Internal Pressure Differential		kPa	Cooling: 54.5 Heating: 94.0		
Noise Level		Condition (Ambient/Water)	A35W7	A7W35	A2W35
		dB (A)	Cooling: 33	Cooling: 33	—
		Power Level dB	Cooling: 46	Cooling: 46	—
Dimension	Height	mm (inch)	717 (28-7/32)		
	Width	mm (inch)	598 (23-17/32)		
	Depth	mm (inch)	1800 (70-27/32)		
Net Weight		kg (lbs)	137 (302)		
Refrigerant Pipe Diameter	Liquid	mm (inch)	9.52 (3/8)		
	Gas	mm (inch)	15.88 (5/8)		
Water Pipe Diameter	Room	mm (inch)	28 (1-3/32)		
	Shower	mm (inch)	19 (3/4)		
Water Drain Hose Inner Diameter		mm (inch)	15 (19/32)		
Pump	Motor Type		DC Motor		
	No. of Speed		7 (Software Selection)		
	Input Power	W	101		
Hot Water Coil	Type		Brazen Plate		
	No. of Plates		44		
	Size (H x W x L)	mm	80 x 119 x 376		
	Water Flow Rate	l/min (m ³ /h)	Cooling: 35.0 (2.1) Heating: 45.9 (2.8)		
Pressure Relief Valve Water Circuit		kPa	Open: 300, Close: 265 and below		
Flow Switch	Type		Magnetic Lead Switch		
	Set Point	l/min	11.1		
Pressure Release Valve		kPa	Open: 1150±200, Close: 700 and below		

Item		Unit	Indoor Unit
Protection Device		A	Residual Current Circuit Breaker (30)
Expansion Vessel	Volume	l	10
	MWP	bar	3
Capacity of Integrated Electric Heater / OLP TEMP		kW / °C	6.00 / 80
Tank Volume (Spec / Nett)		L	200 / 185
Max. Tank Water Set Temperature		°C	65
Tank Coil Surface		m ²	1.8
Maximum Working Pressure	Heat / Cool	Bar	3.0
	Tank Circuit	Bar	10.0
Operating Pressure	Tank Unit	Bar	3.5
	Expansion Relief Valve	Bar	8.0
Expansion Vessel Pre-charge Pressure (DHW Circuit)		Bar	3.5
Pressure Reducing Valve Set Pressure (DHW Circuit)		Bar	3.5
Pressure Vessel	Material		En-1.4521
	Volume	L	185
	Design Pressure	Bar	10
Heat Exchanger	Material		EN-1.4162 / EN-1.4521
	Diameter	mm	22
	Thickness	mm	0.8
	Surface Area	m ²	1.8
	Total Length	m	25
Anode	Material		Aluminium
	Diameter	mm	20
	Length	mm	1000

Note:

- Cooling capacities are based on outdoor air temperature of 35°C Dry Bulb with controlled indoor water inlet temperature of 12°C and water outlet temperature of 7°C.
- Heating capacities are based on outdoor air temperature of 7°C Dry Bulb (44.6°F Dry Bulb), 6°C Wet Bulb (42.8°F Wet Bulb) with controlled indoor water inlet temperature of 30°C and water outlet temperature of 35°C.
- Specifications are subjected to change without prior notice for further improvement.
- * Above 55°C, only possible with backup heater operation.

3. Features

- **Inverter Technology**
 - Energy saving
- **High Efficiency**
- **Environment Protection**
 - Non-ozone depletion substances refrigerant (R410A)
- **Long Installation Piping**
 - Long piping up to 30 meter with height difference 20 meter
 - Flexible 4-way piping for outdoor unit
- **Easy to use control panel**
 - Auto mode
 - Holiday mode
 - Dry concrete function
 - Weekly timer setting
- **A-class energy efficiency pump**
 - Water pump speed can be set by selection at control panel
- **Improved deice cycle**
- **Protection Feature**
 - Random auto restart after power failure for safety restart operation
 - Gas leakage protection
 - Prevent compressor reverse cycle
 - Inner protector to protect compressor
- **Serviceability Feature**
 - Breakdown Self Diagnosis function
 - System Status Check Buttons for servicing purpose
 - System Pumpdown Button for servicing purpose
 - Front maintenance design for outdoor unit

4. Location of Controls and Components

4.1 Indoor Unit

4.1.1 Location of Control

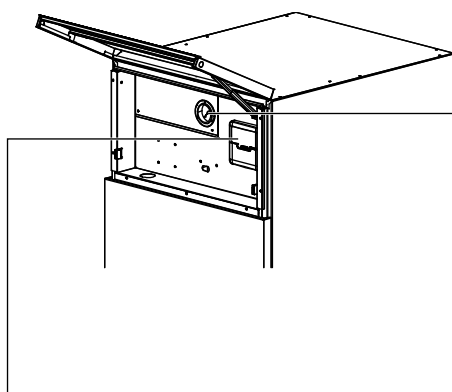

Water pressure gauge



• Do not press or hit the glass cover using hard and sharp objects. Failure to do so may cause damage to the unit.



• Ensure that the water pressure is between 0.05 and 0.3 MPa (0.1 MPa = 1 bar).
• In case the water pressure is out of the above range, consult an authorised dealer.

Control Panel

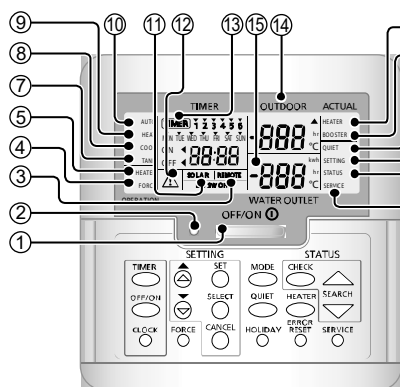

- ① OFF/ON Button
This button starts or stops the mode operation function of the unit.
- ② Operation LED
This LED indicates the unit is in operation.
- ③ External Thermo Controller Connected Display
This LCD show the external thermo controller connected display.
- ④ Force Heater Request OFF/ON Indicator
This icon indicates force heater request OFF/ON mode operation.
- ⑤ Backup Heater Enabled/Disabled Indicator
This icon indicates backup heater enabled/disabled mode operation.
- ⑥ Quiet Mode Indicator
This icon indicates quiet mode operation.
- ⑦ Tank Mode Indicator
This icon indicates tank mode operation.
- ⑧ Cool Mode OFF/ON Indicator
This icon indicates cooling mode OFF/ON operation.
- ⑨ Heat Mode OFF/ON Indicator
This icon indicates heating mode OFF/ON operation.
- ⑩ Auto Mode OFF/ON Indicator
This icon indicates auto mode OFF/ON operation.
- ⑪ Solar Display
This LCD show the solar display.
- ⑫ Caution (Tank Temperature above 60°C) Indicator
This LCD show the Caution display.
- ⑬ Timer/Clock Setting Display
This LCD show the weekly schedule timer setting and clock display.
- ⑭ Outdoor Ambient Temperature Display
This LCD show the outdoor ambient temperature.
- ⑮ Water Outlet Temperature Display
This LCD show the water outlet temperature.
- ⑯ Backup Heater Actual (OFF/ON) Indicator
This icon indicates backup heater actual (OFF/ON) operation.
- ⑰ Booster Heater Actual (OFF/ON) Indicator
This icon indicates booster heater actual (OFF/ON) operation.
- ⑱ System Setting Mode OFF/ON Indicator
This icon indicates the system setting mode request OFF/ON display.
- ⑲ System Status Check Mode OFF/ON Indicator
This icon indicates the status check mode request OFF/ON display.
- ⑳ System Service Mode OFF/ON Indicator
This icon indicates the system service mode request OFF/ON display.

4.1.2 To adjust initial settings

Dealer

Select menus and determine settings according to the system available in the household. It is recommended that all alterations of settings are done by an authorised dealer or specialist.

- After initial installation, you may manually adjust the settings. The initial setting remains active until the user changes it.
- Ensure the operation LED is OFF before setting.
- The system may not work properly if set wrongly. Please consult an authorised dealer.

- 1 Press **SET** and **CHECK** simultaneously and hold for 5 seconds until the display shows **SETTING STATUS**.
- 2 Press **▲** or **▼** to select the menu.
- 3 Press **SELECT** to enter the menu.
- 4 Press **▲** or **▼** to select Yes/No, or other options.
YES: to enable the menu
No: to disable the menu
- 5 Press **SET** to confirm.

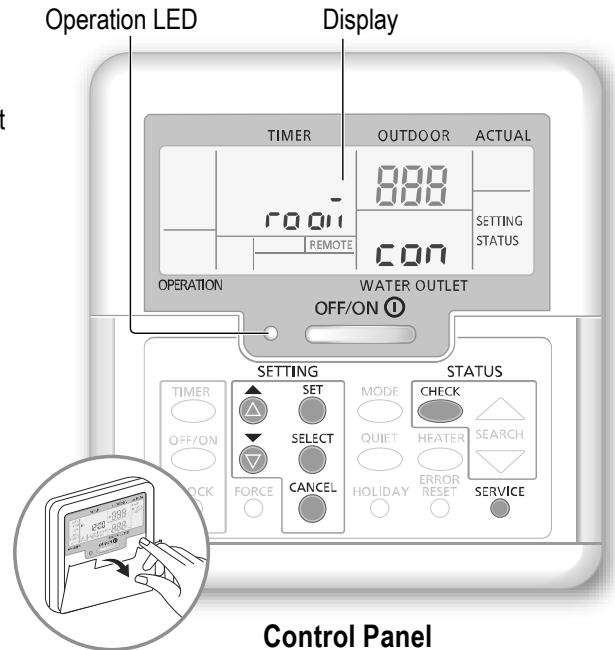

Before Indoor Unit operate, its Capacity Rank has to match with connected Outdoor Unit. See below table for detail.

Model		Capacity Rank
Indoor Unit	Outdoor Unit	
WH-ADC1216G6E5	WH-UX09FE5	9
	WH-UX12FE5	12
	WH-UD12FE5	12
	WH-UD16FE5	16

System Capacity Rank Setting

The Capacity Rank can be set by Control Panel

- 1 Press **SET** and **SERVICE** buttons simultaneously for 5 seconds.
- 2 Press **▲** or **▼** button to select menu **CAP RAN**.
- 3 Press **SELECT** button then press **▲** or **▼** button to change capacity rank and press **SET** button to confirm the outdoor capacity rank.
- 4 Press **CANCEL** button and Exit to home display.

Menu (1 ~ 15)	Default Setting	Setting		Display
1 Room Thermostat Connection To select whether or not to connect to the optional room thermostat.	NO	YES	NO	ROOM CON
2 Indoor Backup Heater Selection To reduce the heater power if unnecessary. *Options of kW vary depending on the model.	9 kW	*3 kW / 6 kW / 9 kW		HEATER CAP
3 Water System Freeze Prevention To activate or deactivate the water freeze prevention when the system is OFF.	YES	YES	NO	Anti Freeze
4 *1,*2 Cooling/Heating Operation Interval To set the interval for COOL or HEAT mode during COOL + TANK or HEAT + TANK mode.	30 minutes	0.5 hours ~ 10 hours		COOL/HEAT int
5 *1 Tank Heat-up Interval To set the interval for the water tank during COOL + TANK or HEAT + TANK mode.	1 hour 35 minutes	5 minutes ~ 1 hour 35 minutes		TANK int





Dealer Operation/settings to be done only by the authorised dealer/specialist.

User Operation/settings to be done by the authorised dealer/specialist or user.

6 Backup Heater For Tank To activate backup heater during tank operation.	YES	YES	NO	HEATER Fun
<ul style="list-style-type: none"> Do not use the system during sterilisation in order to prevent scalding with hot water, or overheating of shower. Ask an authorised dealer to determine the level of sterilisation function field settings according to the local laws and regulations. 				
7 Sterilisation To sterilise the water tank, if required. Note: If NO is selected, menus 8 to 10 are skipped.	YES	YES	NO	St rL Fun
8 Sterilisation Day & Time To set timer for sterilisation. (Only once a week. Operates even under a standby condition)	Monday 12:00	Monday ~ Sunday 0:00 ~ 23:50		St r
9 Sterilisation Temperature To set the temperature of sterilisation.	65 °C	40 °C ~ 65 °C		St rL bo i
10 Continuation of Sterilisation To maintain heating temperature in order to complete the sterilisation.	10 minutes	5 minutes ~ 1 hour		St r aPr
11 Base Pan Heater To select whether or not to connect to the optional base pan heater. Note: If NO is selected, menu 12 is skipped.	NO	YES	NO	bP An htr
12 Base Pan Heater type Type A - The base pan heater activates only during deice operation. Type B - The base pan heater activates when outdoor ambient temperature is 5 °C or lower.	A	A	B	bP An htr
13 *1,*2 Cool Outdoor Temperature setting To set the outdoor ambient temperature for the AUTO mode to change from HEAT to COOL.	15 °C	5 °C ~ 25 °C		H -C SEt
14 *1,*2 Heat Outdoor Temperature setting To set the outdoor ambient temperature for the AUTO mode to change from COOL to HEAT.	10 °C	5 °C ~ 25 °C		C -H SEt
15 Dry Concrete During construction to dry the concrete under a preset temperature. Do not use this menu for any other purposes and in period other than during construction (Refer to Information page).	-	1 day ~ 99 days		dr y Con

User

Control panel preparation

- Press .
- Press  or  to set the current day.
- Press  to confirm.
- Repeat steps ② and ③ to set the current time.

Note:

- The current day and time need to be set in cases below:
 - When the power is turned on for the first time.
 - A long time has elapsed since the power was turned on the last time.
- The current time that has been set will be the standard time for all the timer operations.

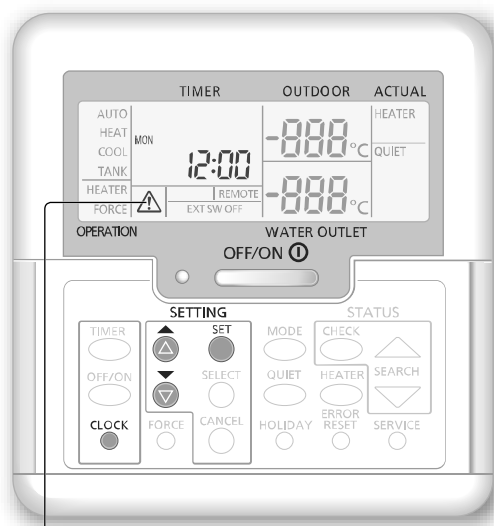

Caution Indicator (Tank Temperature above 60 °C)

*1 The system is locked to operate without COOL mode. It can be unlocked only by authorised installers or our authorised service partners.

*2 Only displayed when COOL mode is unlocked (Means when COOL mode is available).

4.1.3 How to use

User

Turn on or off the system

Press .

When the system is ON, the operation LED is lit and the actual water outlet temperature and outdoor ambient temperature are shown on the display.

User

Select operation mode

Press  to select operation mode.

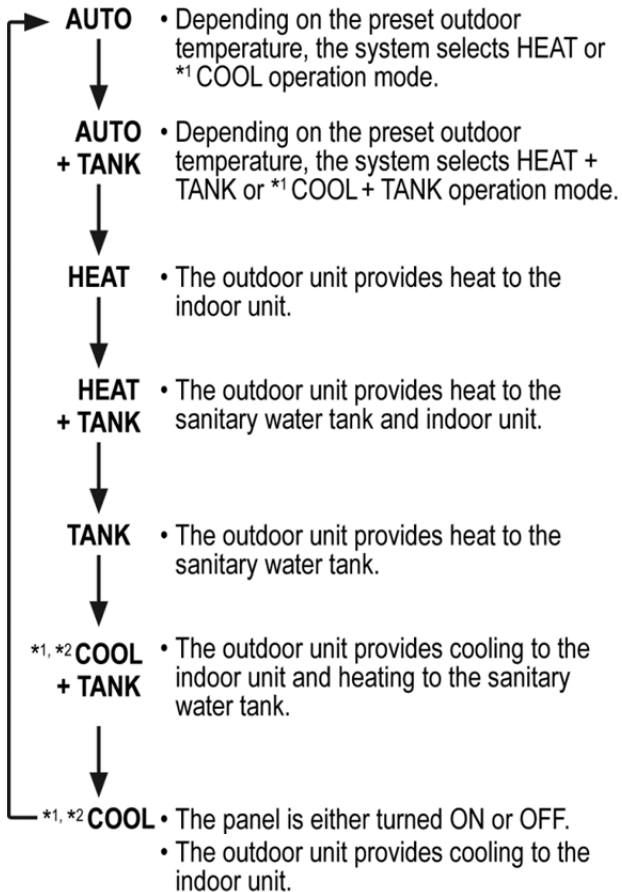

User

Initiate the backup heater

Press .

- The backup heater provides extra heat at low outdoor temperature. The backup heater is possible only in the heat mode.
- Once the backup heater is set, it is automatically operated when conditions are fulfilled.
- To disable the backup heater, press  again.

The system is turned off by an external switch.

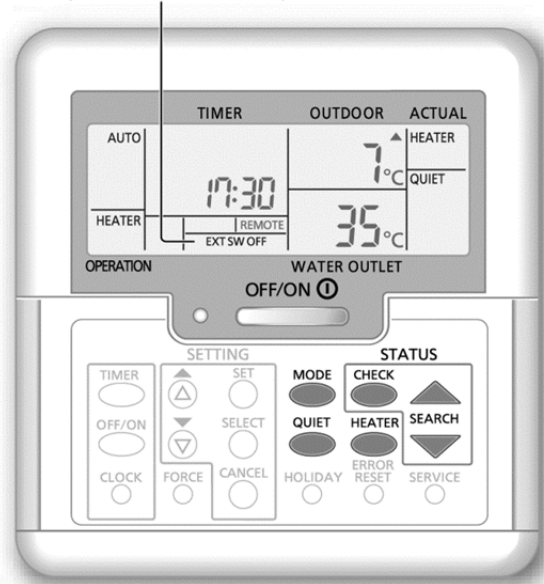

User





Enjoy quiet operation

Press .

- This operation reduces the noise of outdoor unit. The operation may cause heating/*1 cooling ability to decrease.

User

System status check mode

- ① Press .
(The display shows STATUS.)
- ② Press  or  to check the selected mode.
 - Dry concrete (does not show during normal operation)
 - The Water Inlet Temperature
 - Tank Temperature
 - Compressor Running Frequency
 - Error History
 - Heat mode total power consumption (Up to 999 days)
 - *1 Cool mode total power consumption (Up to 999 days)
 - Tank mode total power consumption (Up to 999 days)
 - Press  to exit the STATUS mode.

Note:

- Once the STATUS mode is entered, the display shows STATUS.
- The STATUS mode cannot be activated when the display shows SETTING.
- The total power consumption is an estimated value based on AC 230 V and may differ from value measured by precise equipment.

■ **Note:** In normal operation, the , , and  buttons are not in use.

Dealer Operation/settings to be done only by the authorised dealer/specialist.

User Operation/settings to be done by the authorised dealer/specialist or user.

Dealer

System temperature setting

The system controls the temperature for each menu based on the outdoor ambient temperature.

• To set or change the temperatures, make sure to contact your nearest authorised dealer.

- ① Press and hold **SET** for 5 seconds to enter the temperature range setting mode.
(The display shows SETTING.)
 - ② Press **▲** or **▼** to select a menu.
 - ③ Press **SELECT** to enter the menu.
 - ④ Press **▲** or **▼** to set the desired temperature.
 - ⑤ Press **SET** to confirm the setting.
- Repeat steps ② to ⑤ to set other menus.

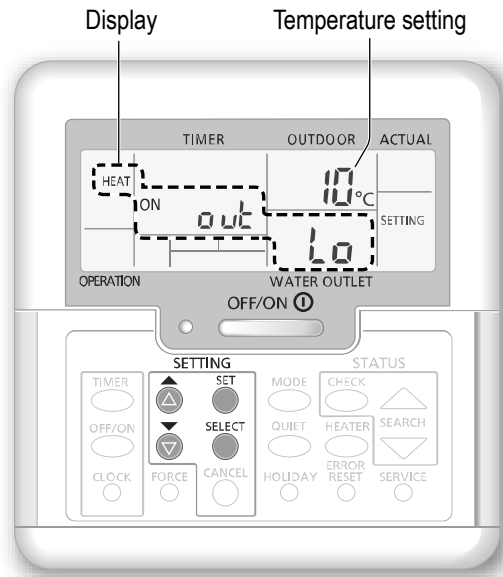

User

Checking the temperature range

- ① Press and hold **SET** for 5 seconds to enter the temperature range setting mode.
 - ② Press **▲** or **▼** to select a menu.
- Press **CANCEL** to exit.





Menu	Default setting	Temperature setting	Display	
Setting of low outdoor ambient temperature.	-5 °C	-15 °C ~ 15 °C	HEAT	ON out Lo
Setting of high outdoor ambient temperature.	15 °C	-15 °C ~ 15 °C		ON out Hi
Setting of water outlet temperature at low outdoor ambient temperature.	55 °C	25 °C ~ 55 °C		ON H2O Lo
Setting of water outlet temperature at high outdoor ambient temperature.	35 °C	25 °C ~ 55 °C		ON H2O Hi
<p>During HEAT mode, the water outlet temperature is adjusted as is shown the diagram on the right. It is performed within the preset temperature range.</p> <div style="display: flex; align-items: center;"> <div style="margin-right: 20px;"> <p><Water outlet temperature></p> <p>H2O Lo</p> <p>H2O Hi</p> </div> </div> <p style="text-align: center;"><Outdoor ambient temperature></p>				
Setting of outdoor ambient temperature to turn OFF heating operation during HEAT mode.	24 °C	5 °C ~ 35 °C	HEAT	OFF SET
Setting of outdoor ambient temperature to turn ON the backup heater.	0 °C	-15 °C ~ 20 °C	HEATER	ON out SET
Setting of water outlet temperature during *1 COOL mode.	10 °C	5 °C ~ 20 °C	*1, *2 COOL	SET
Setting of sanitary water tank temperature.	52 °C	40 °C ~ 65 °C	TANK	SET

*1 The system is locked to operate without COOL mode. It can be unlocked only by authorised installers or our authorised service partners.

*2 Only displayed when COOL mode is unlocked (Means when COOL mode is available).

Shifting the water temperature

This easily shifts the water outlet temperature if the setting is undesirable.

- ① Press  to enter the water temperature shifting mode.
- ② Press  to change setting.
- ③ Press  or  to set the desired temperature.
(temperature range: -5 °C ~ 5 °C)

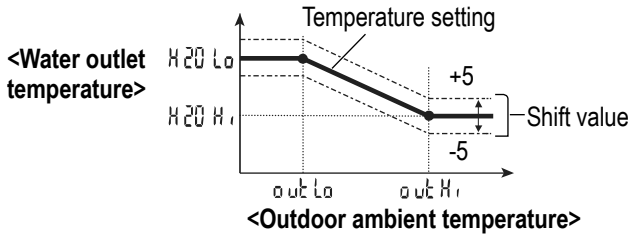

- ④ Press  to confirm the setting.

Note:

- Press  or wait for 30 seconds to exit the SETTING mode.
- The set temperature will be saved in the system once confirmed.
- The SETTING mode cannot be activated when the SERVICE and STATUS indicators are ON.
- The system will shift the temperature within water outlet temperature range.

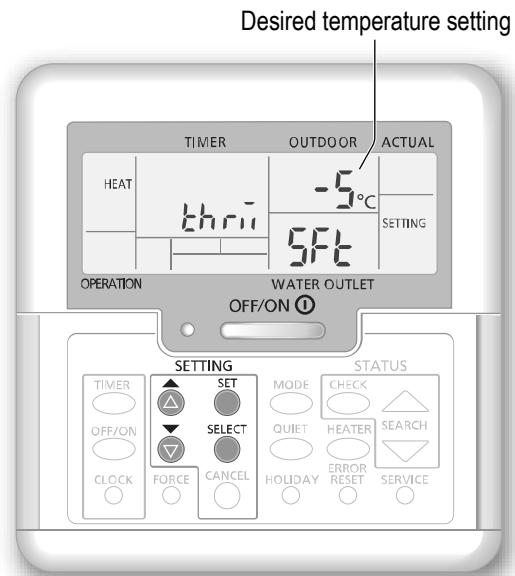





Holiday mode

- By setting the day (s) in holiday mode, it promotes energy saving while you are on holiday, and enables the system to resume at the preset temperature after your holiday.
- Ensure that the system is OFF before setting.
- The system will resume operation automatically at 00:00 am after the holiday.
- The day the HOLIDAY mode was set is counted as day 1.

Example:

Setting the holiday mode on June 21, 08:00 am. By setting 3 days, the system resumes operation on June 24, 00:00 am.

- ① Press  to enter the HOLIDAY mode.
- ② Press  or  to set the desired days.
(Setting range: 1 day ~ 999 days)
- ③ Press  to confirm the setting.

Note:

- Press  or wait 30 seconds to exit the HOLIDAY mode.

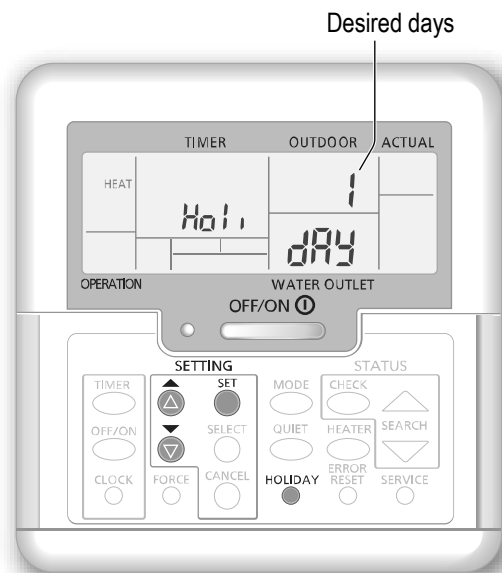

Dealer Operation/settings to be done only by the authorised dealer/specialist.

User Operation/settings to be done by the authorised dealer/specialist or user.

User

Weekly timer setting

Promotes energy saving by allowing you to set up to 6 programmes in any given day.

Lights up if Timer operation is selected

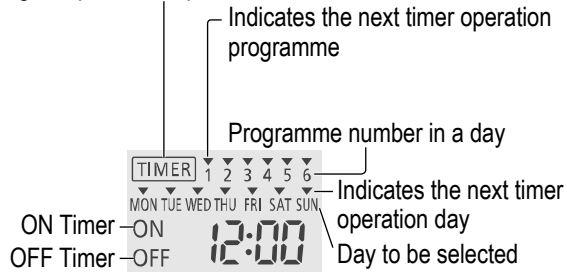

- 1 Press **TIMER** to enter the timer setting mode.
- 2 Press **▲** or **▼** to select your desired day.
- 3 Press **SELECT** to confirm your selection.
- 4 "1" will be blinking, press **SELECT** to set programme 1.
- 5 Press **OFF/ON** to select ON or OFF timer.
- 6 Press **▲** or **▼** to select your desired time. You can set **MODE**, **QUIET**, **HEATER** and the Water Temperature Thermo Shift setting.
- 7 Press **SET** to confirm programme 1. The selected day will be highlighted with **▼**.
 - After 2 seconds, the display will move to the next programme. Repeat steps 4 to 7 to set programmes 2 to 6.
 - During timer setup, if no button is pressed within 30 seconds, or if the **SET** is pressed, the setting at that moment is confirmed and timer setup is ended.

To check current timer programme

- 1 Press **TIMER** to enter timer mode and press **SELECT** to enter day setting.
- 2 Press **▲** or **▼** until your desired day is shown, press **SELECT** to confirm your selection.
- 3 Press **▲** or **▼** to check the set programmes.

■ Note:

- You may set the timer for each day of the week (Monday to Sunday) with 6 programmes per day.
- When the system is switched on by the timer, it will use the previously set temperature to control the water outlet temperature.
- The same timer programme cannot be set on the same day.
- You may also select 2 or more days with the same timer setting.

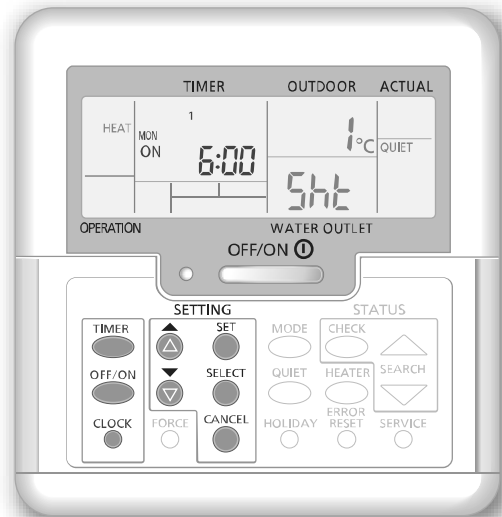

To modify current timer programme or add new timer programme

- 1 Perform steps 1 to 7 of "Weekly timer setting" to modify existing timer programme, or add any timer programme.

To cancel current timer programme

- 1 Press **SELECT** to enter day.
- 2 Press **▲** or **▼** until your desired day is shown, press **SELECT** to enter programme setting.
- 3 Press **▲** or **▼** until your desired programme is shown. Press **CANCEL** to cancel the programme and **▼** will disappear.

To disable/enable Weekly Timer

- To disable weekly timer setting, press **TIMER**, then press **CANCEL**.
- To enable previous weekly timer setting, press **TIMER**, then press **SET**.

Dry Concrete Function

- During construction to dry the concrete under a preset temperature.

① Press  and  simultaneously and hold for 5 seconds until the display shows "r0 00 con".

② Press .

(The display shows "dr 4 con").

③ Press  to select day.

Press  or  to set the desired temperature.

④ Press  to confirm the selection.

⑤ Repeat step ③ and ④ to set other days and temperature.

- Press  to exit.

4.1.4 Main Components

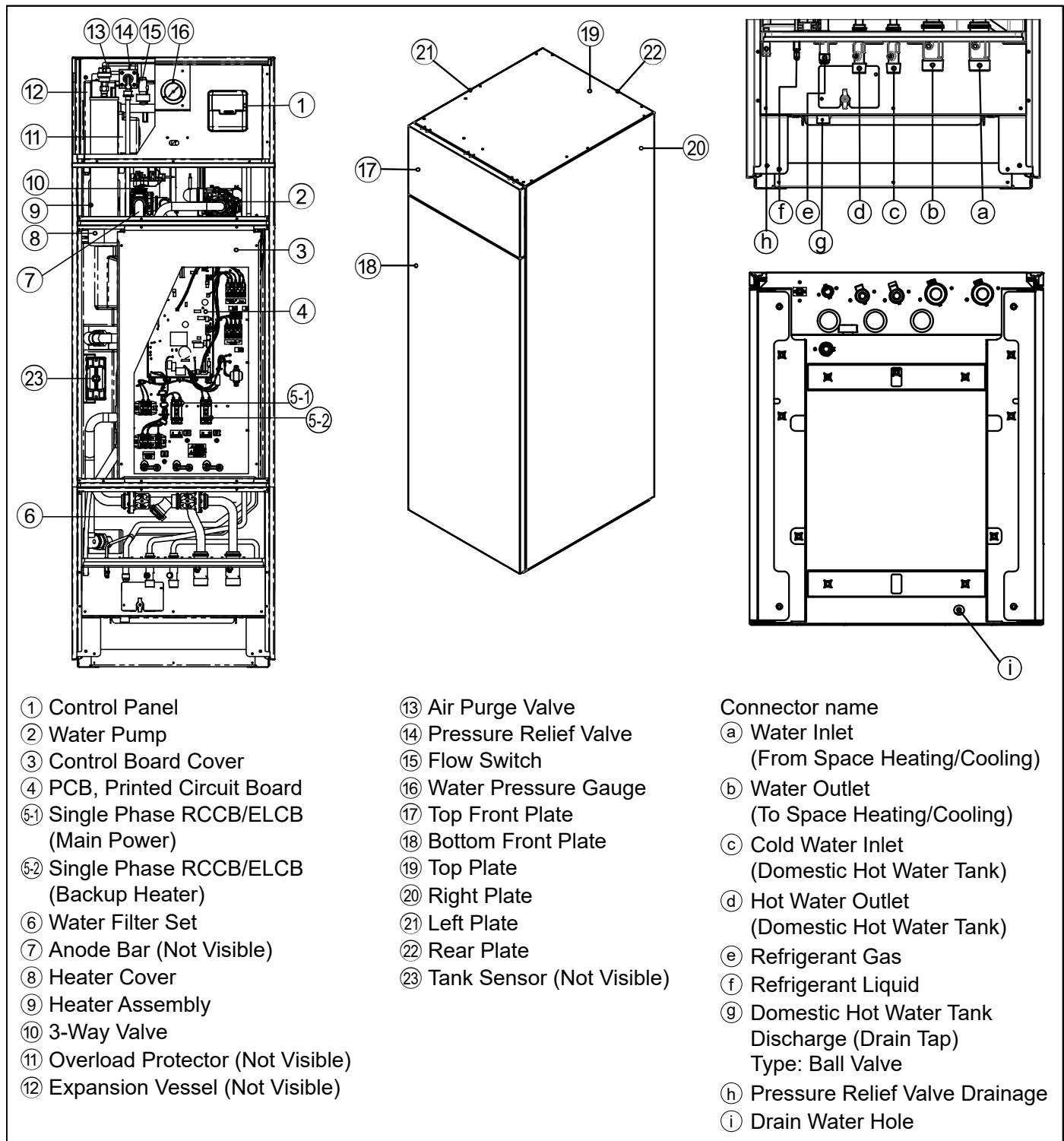

- ① Control Panel
- ② Water Pump
- ③ Control Board Cover
- ④ PCB, Printed Circuit Board
- ⑤-1 Single Phase RCCB/ELCB (Main Power)
- ⑤-2 Single Phase RCCB/ELCB (Backup Heater)
- ⑥ Water Filter Set
- ⑦ Anode Bar (Not Visible)
- ⑧ Heater Cover
- ⑨ Heater Assembly
- ⑩ 3-Way Valve
- ⑪ Overload Protector (Not Visible)
- ⑫ Expansion Vessel (Not Visible)

- ⑬ Air Purge Valve
- ⑭ Pressure Relief Valve
- ⑮ Flow Switch
- ⑯ Water Pressure Gauge
- ⑰ Top Front Plate
- ⑱ Bottom Front Plate
- ⑲ Top Plate
- ⑳ Right Plate
- ㉑ Left Plate
- ㉒ Rear Plate
- ㉓ Tank Sensor (Not Visible)

- Connector name
- Ⓐ Water Inlet (From Space Heating/Cooling)
 - Ⓑ Water Outlet (To Space Heating/Cooling)
 - Ⓒ Cold Water Inlet (Domestic Hot Water Tank)
 - Ⓓ Hot Water Outlet (Domestic Hot Water Tank)
 - Ⓔ Refrigerant Gas
 - Ⓕ Refrigerant Liquid
 - Ⓖ Domestic Hot Water Tank Discharge (Drain Tap) Type: Ball Valve
 - Ⓗ Pressure Relief Valve Drainage
 - Ⓘ Drain Water Hole

4.2 Outdoor Unit

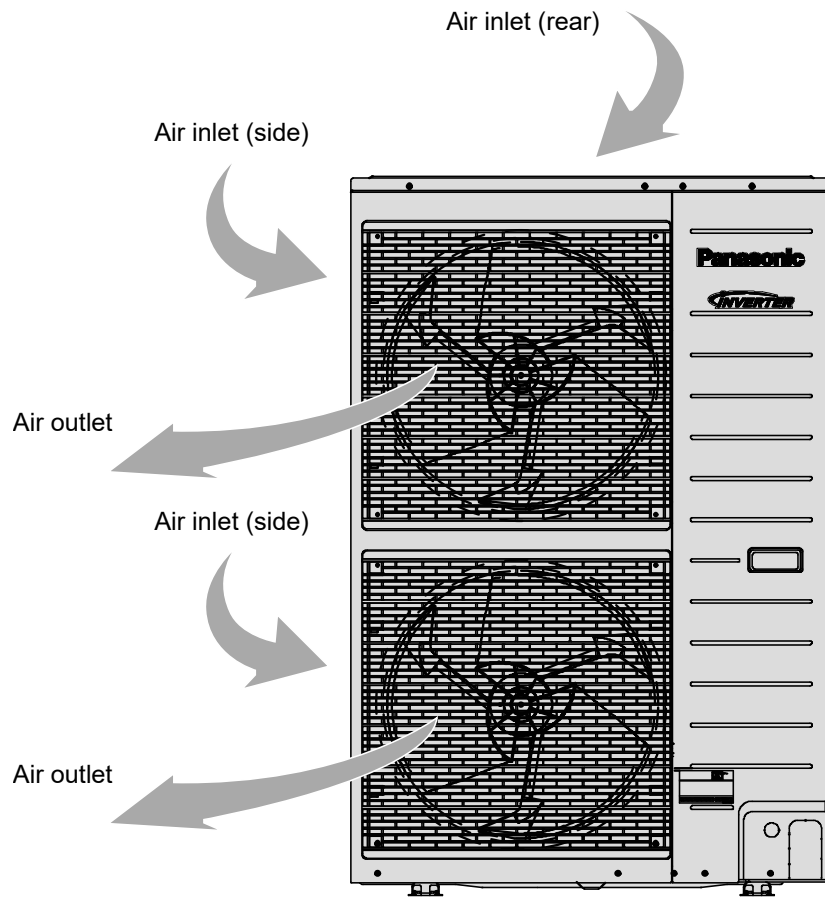

5. Dimensions

5.1 Indoor Unit

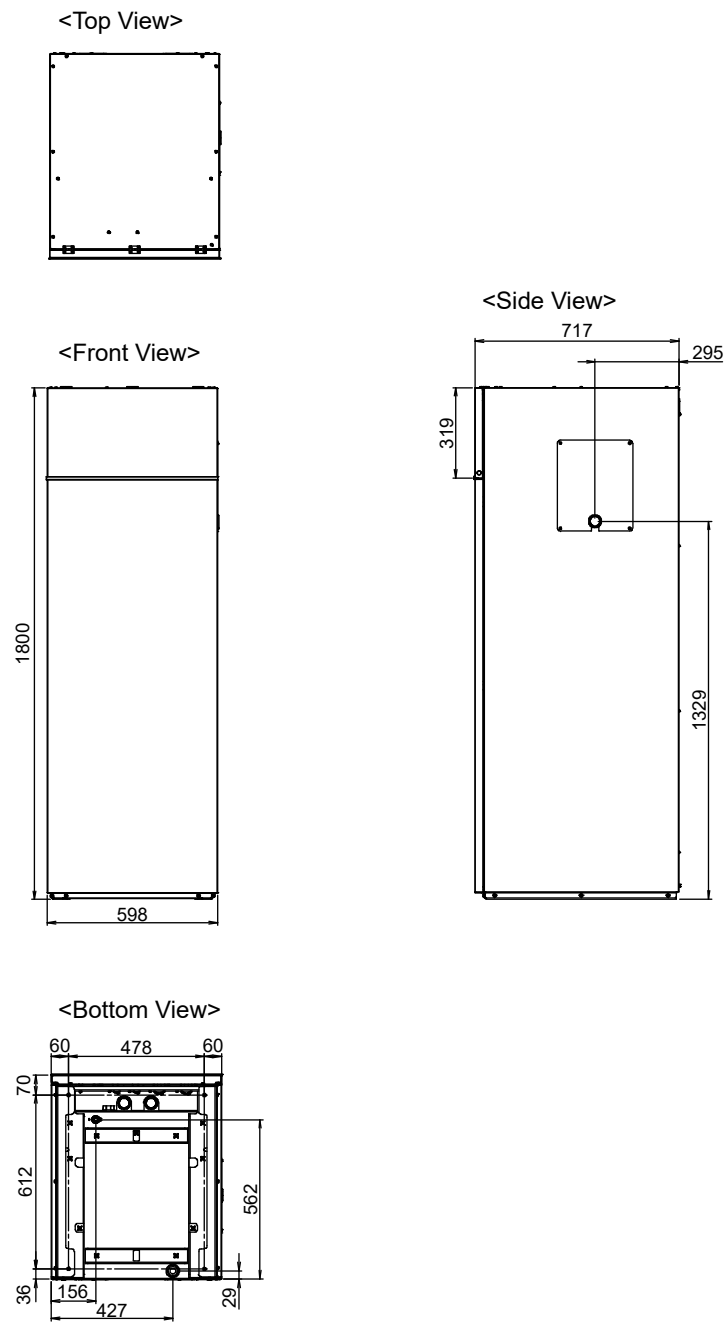

Unit: mm

5.2 Outdoor Unit

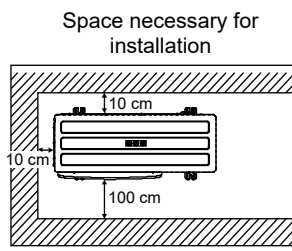

Anchor Bolt Pitch
355 x 260

<Side View>

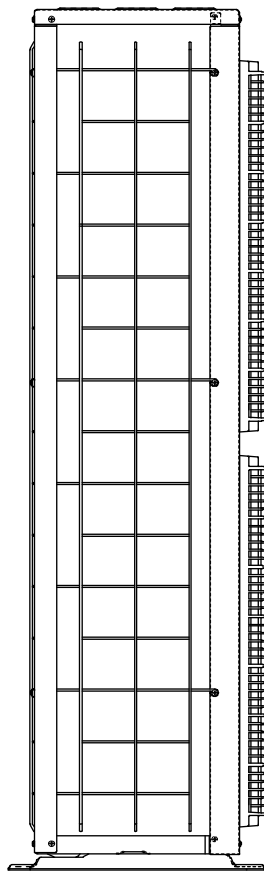

<Top View>

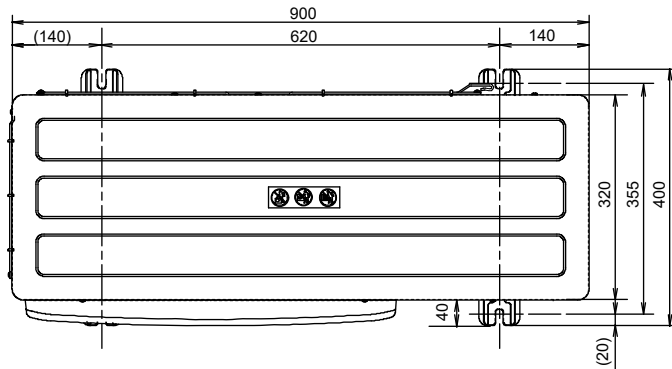

<Front View>

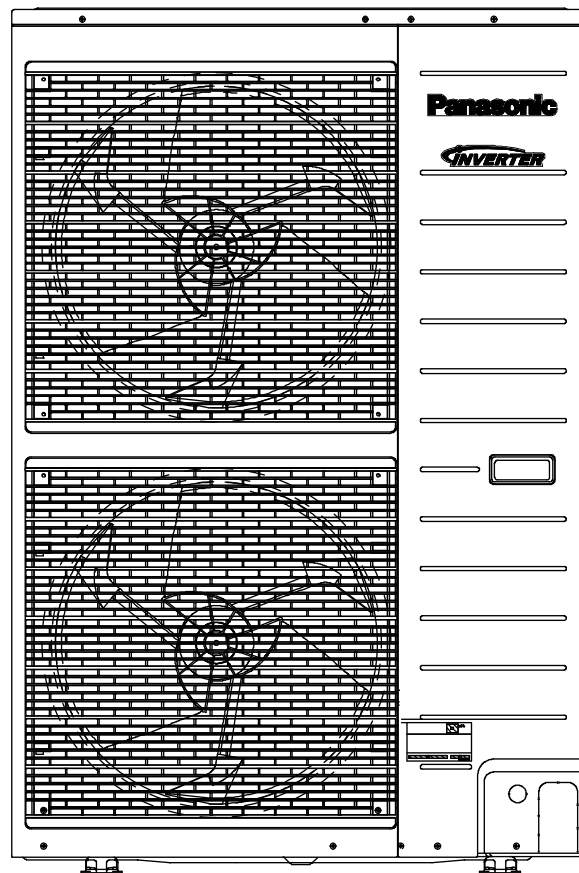

<Side View>

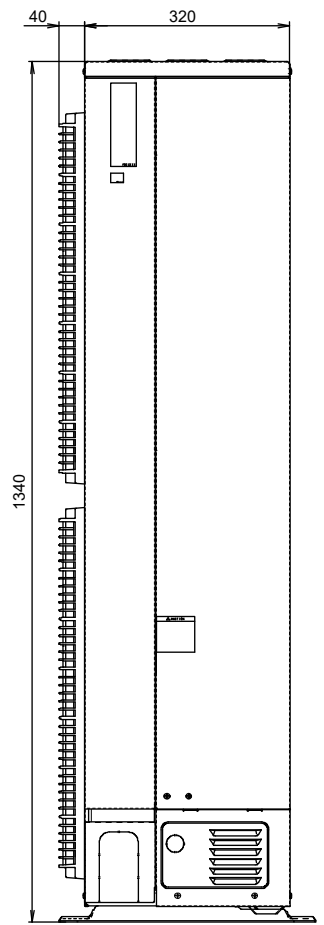

Unit: mm

6. Refrigeration and Water Cycle Diagram

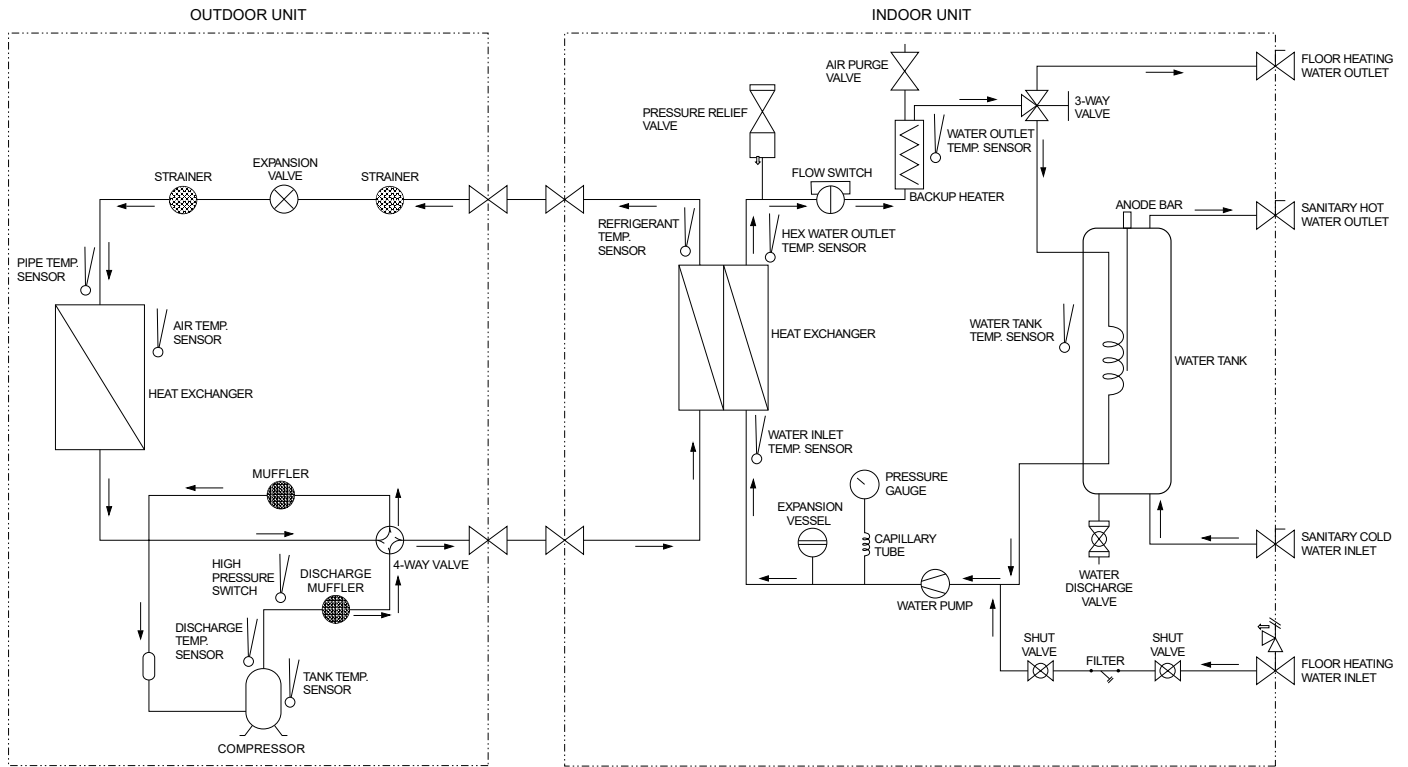

Tank Unit	Model	Piping size (Torque)	
	Outdoor Unit	Gas	Liquid
ADC1216*E5*	UX09*E5* / UX12*E5* / UD12*E5* / UD16*E5*	Ø15.88 mm (5/8") [65 N•m]	Ø9.52 mm (3/8") [42 N•m]

7. Block Diagram

7.1 WH-ADC1216G6E5 WH-UX09FE5 WH-ADC1619G6E5 WH-UX12FE5

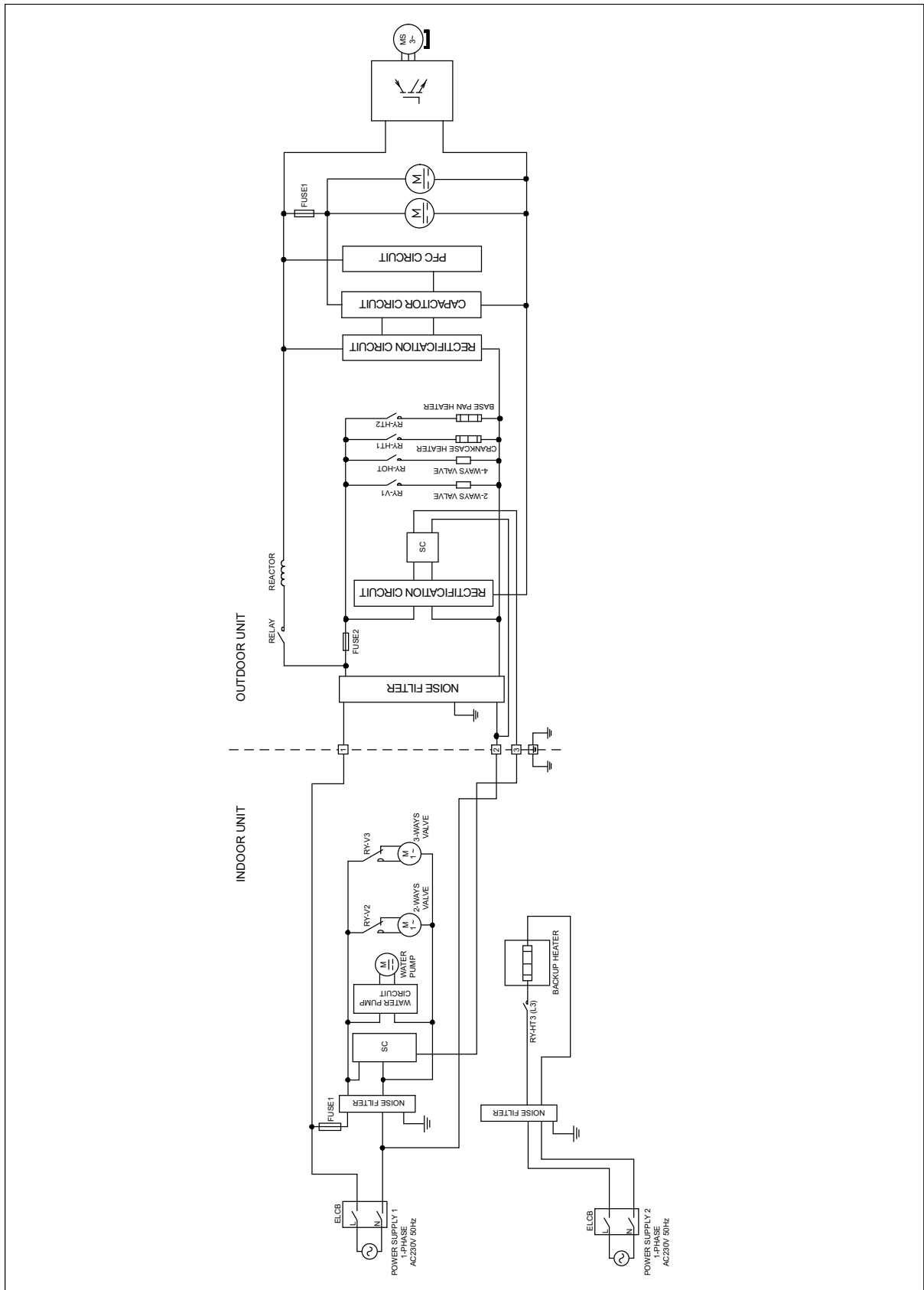

7.2 WH-ADC1216G6E5 WH-UD12FE5 WH-ADC1216G6E5 WH-UD16FE5

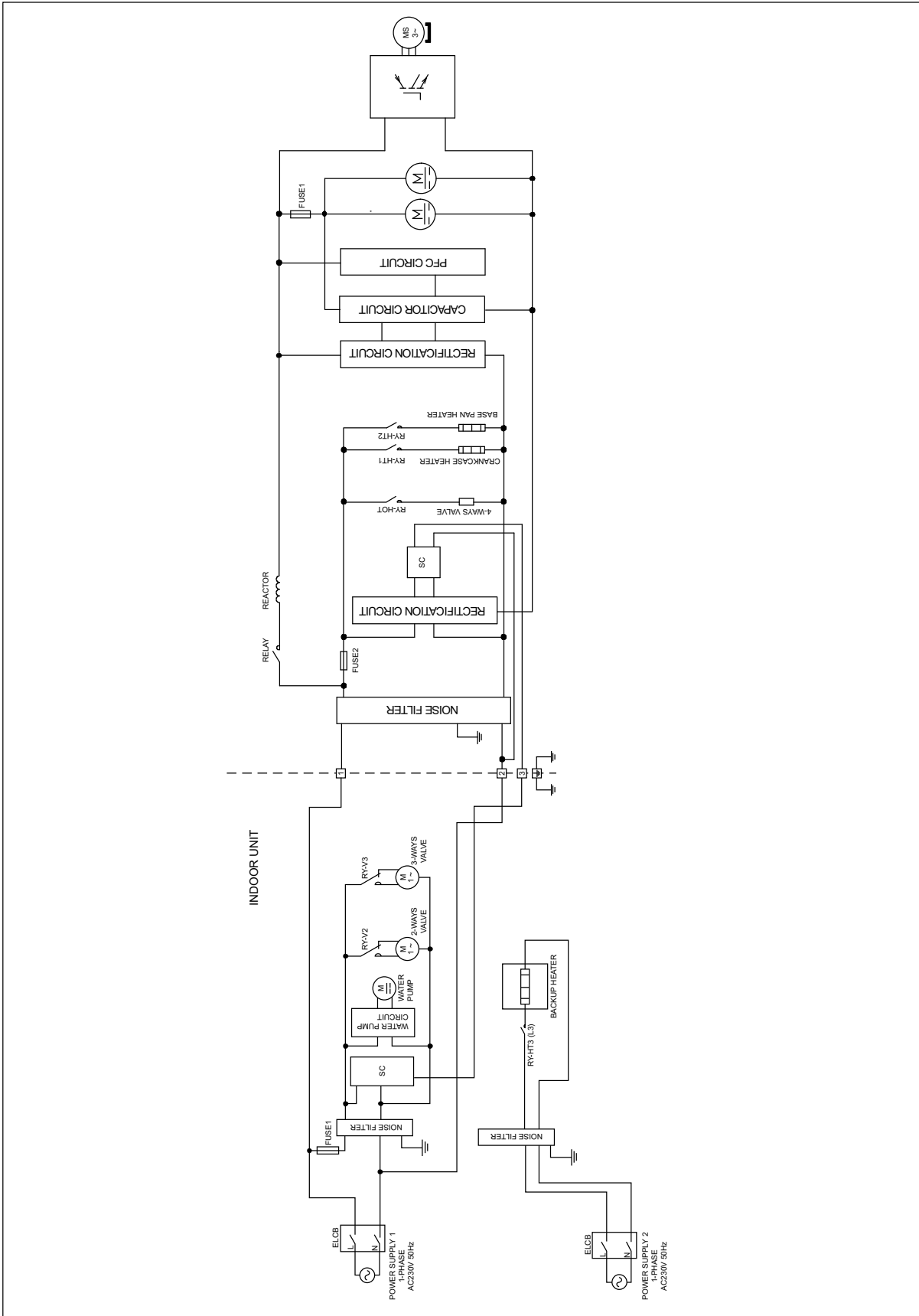

8. Wiring Connection Diagram

8.1 Indoor Unit

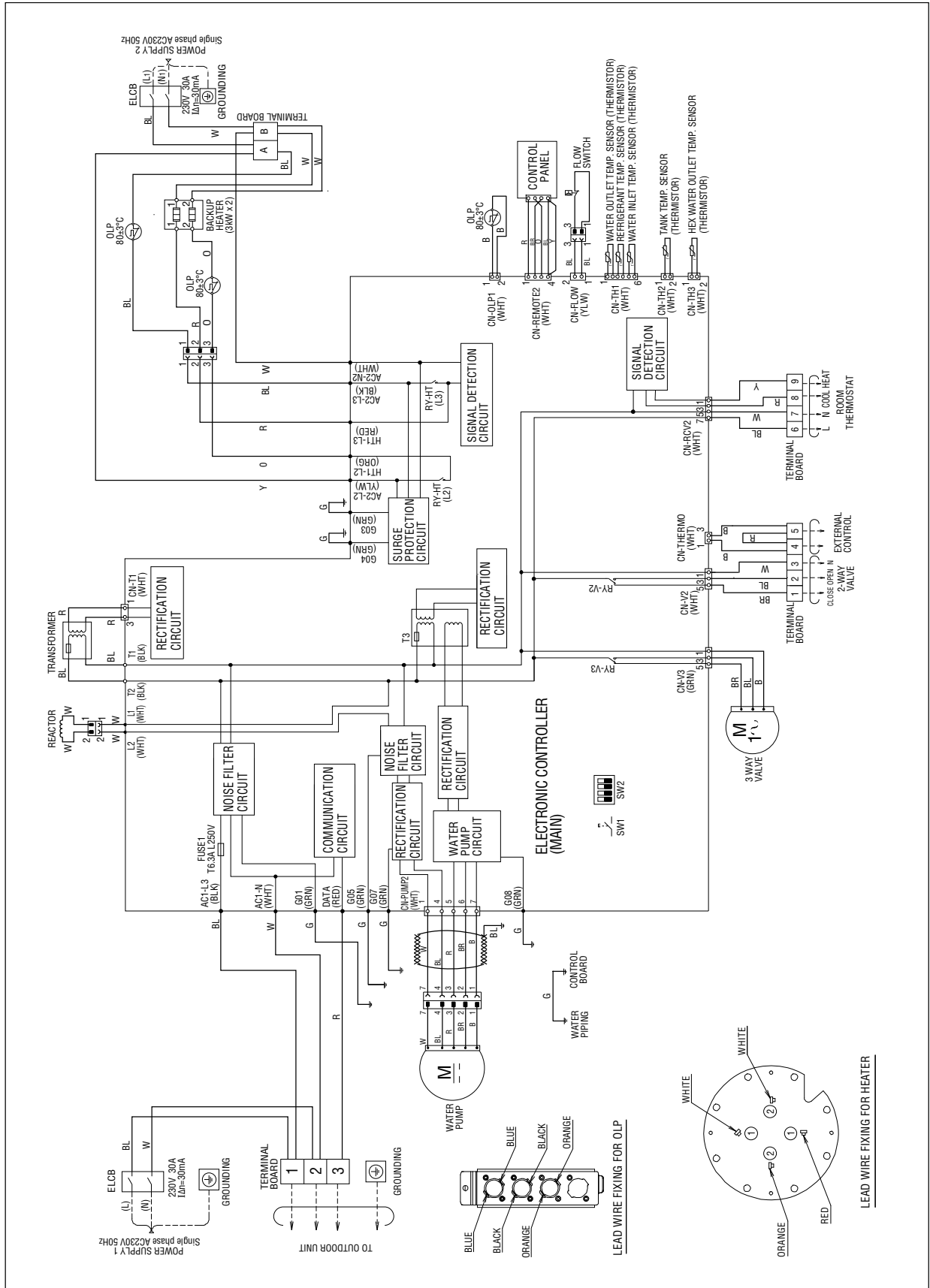

8.2 Outdoor Unit

8.2.1 WH-UX09FE5 WH-UX12FE5

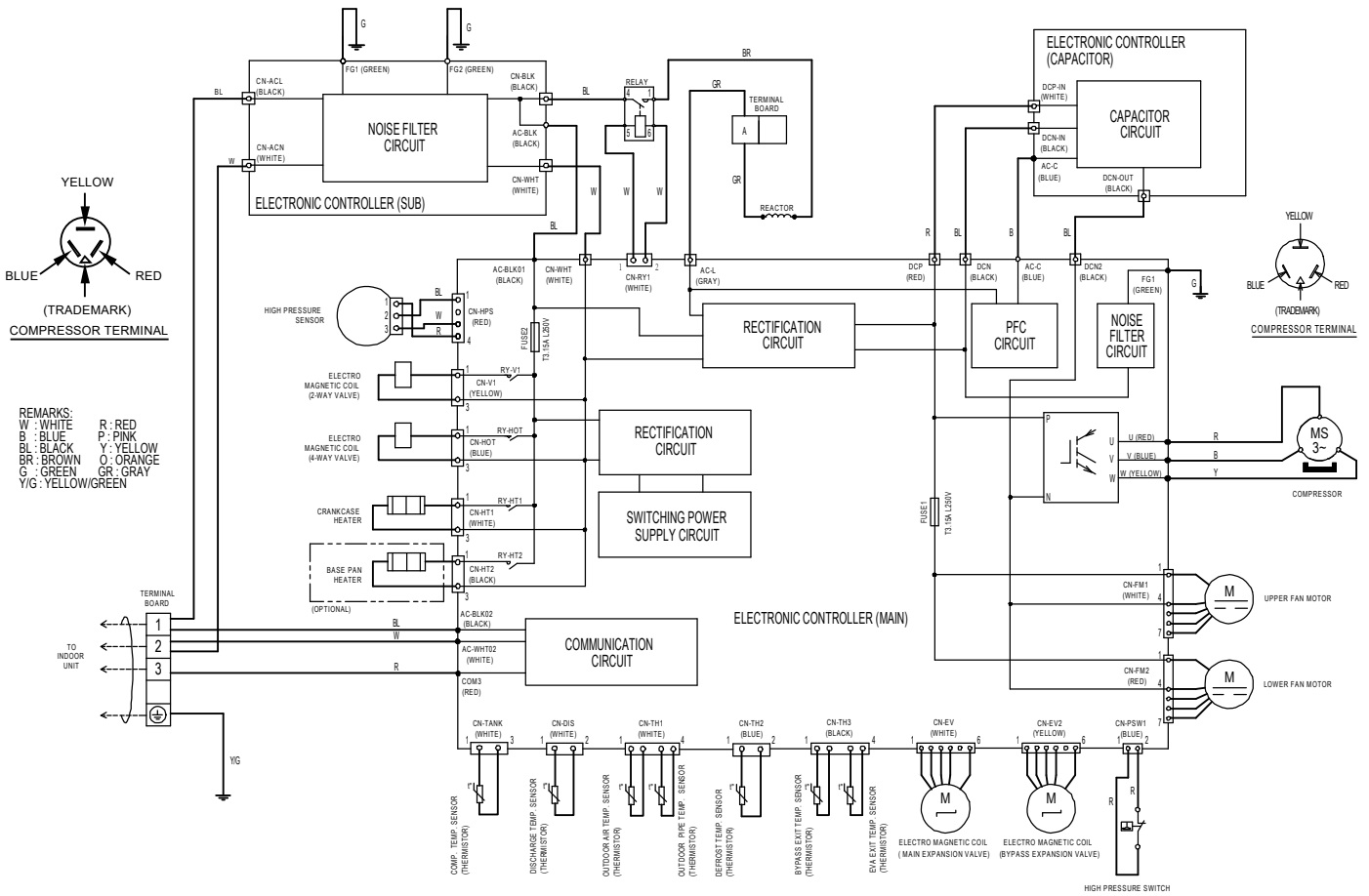

Resistance of Compressor Windings

MODEL	WH-UX09FE5 / WH-UX12FE5
CONNECTION	5JD420XAA22
U - V	0.435 Ω
V - W	0.452 Ω
U - W	0.441 Ω

Note: Resistance at 20°C of ambient temperature.

8.2.2 WH-UD12FE5 WH-UD16FE5

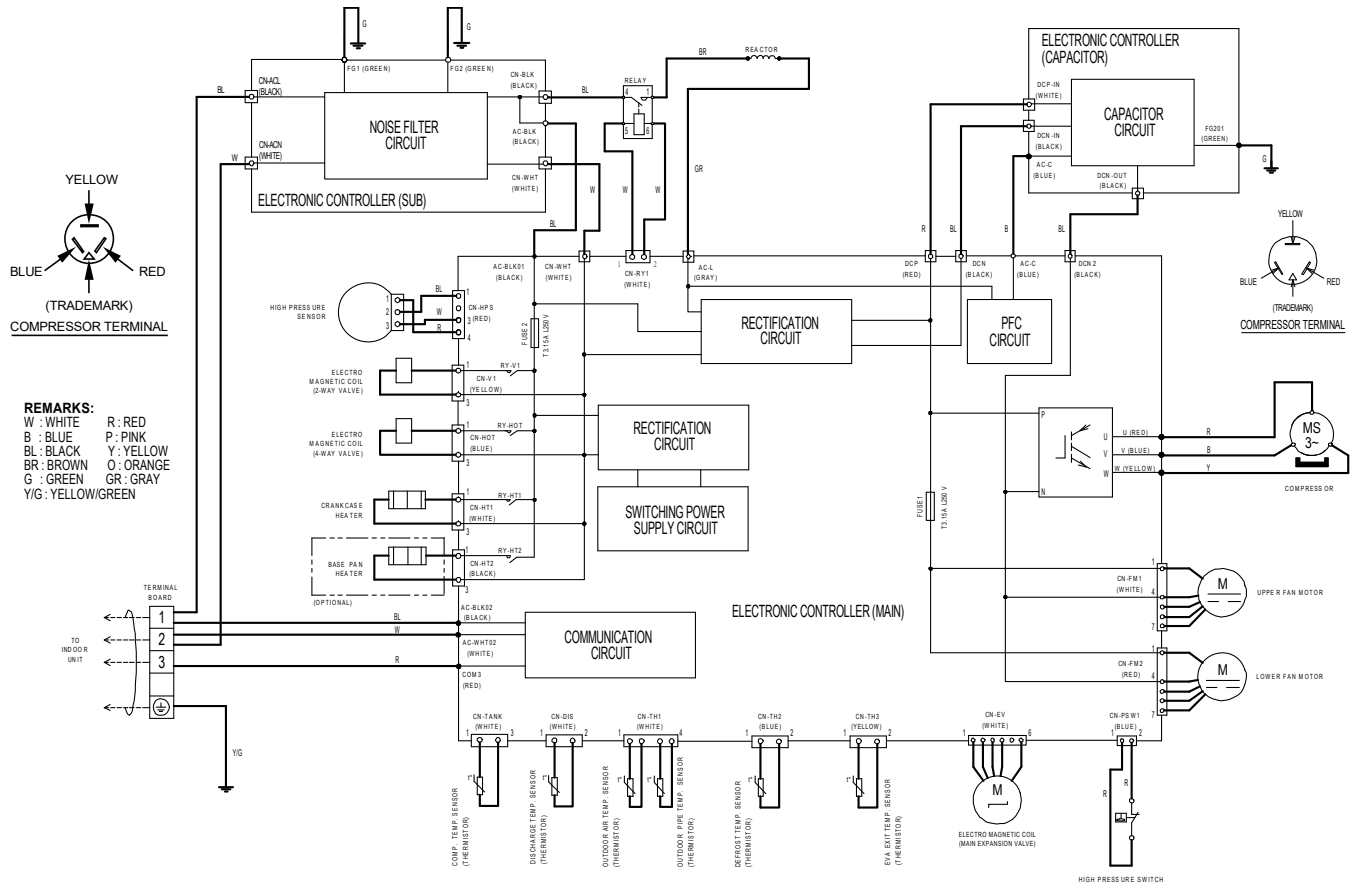

Resistance of Compressor Windings

MODEL	WH-UD12FE5 / WH-UD16FE5
CONNECTION	5JD420XAA22
U - V	0.435 Ω
U - W	0.452 Ω
V - W	0.441 Ω

Note: Resistance at 20°C of ambient temperature.

9. Electronic Circuit Diagram

9.1 Indoor Unit

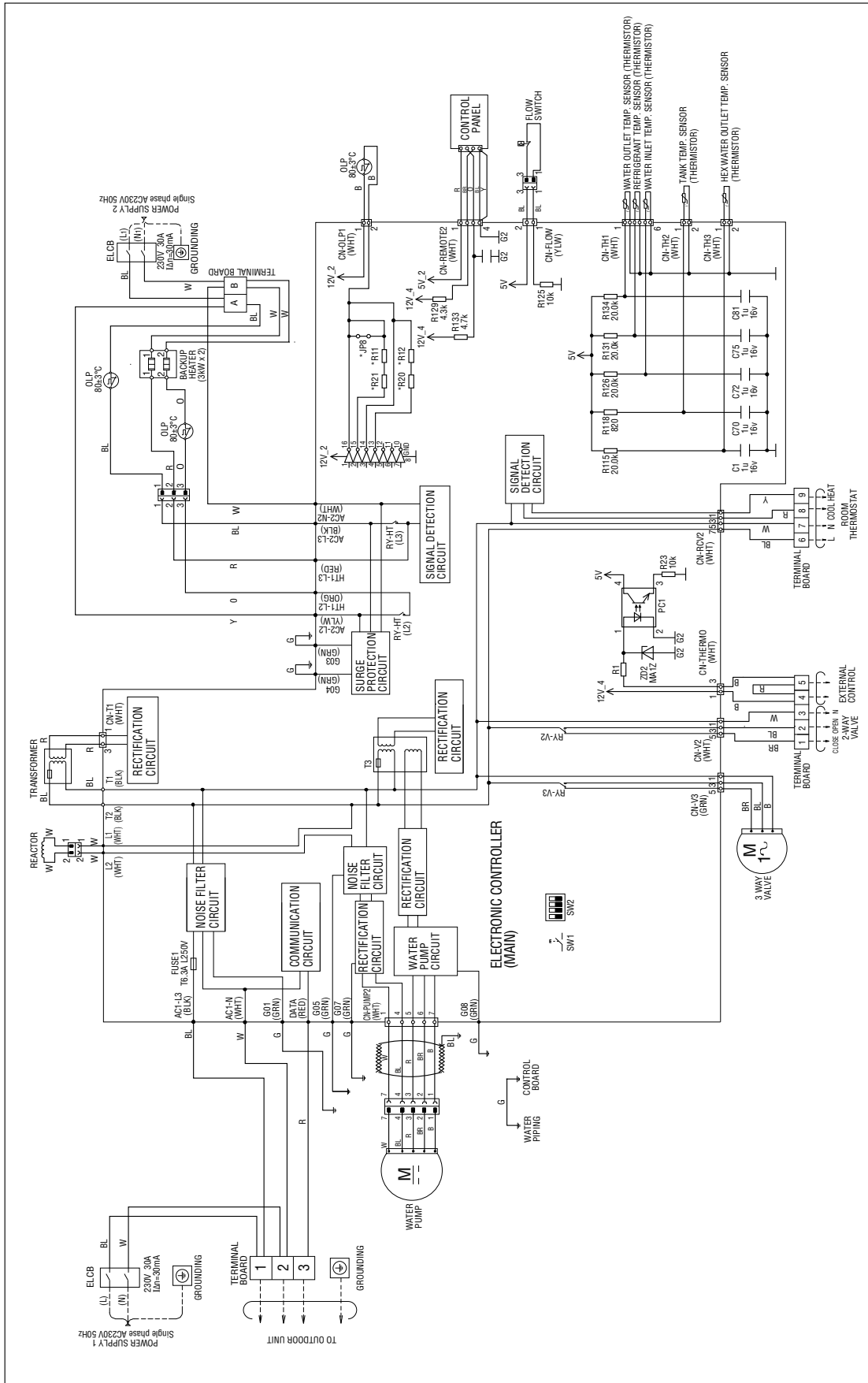

9.2 Outdoor Unit

9.2.1 WH-UX09FE5 WH-UX12FE5

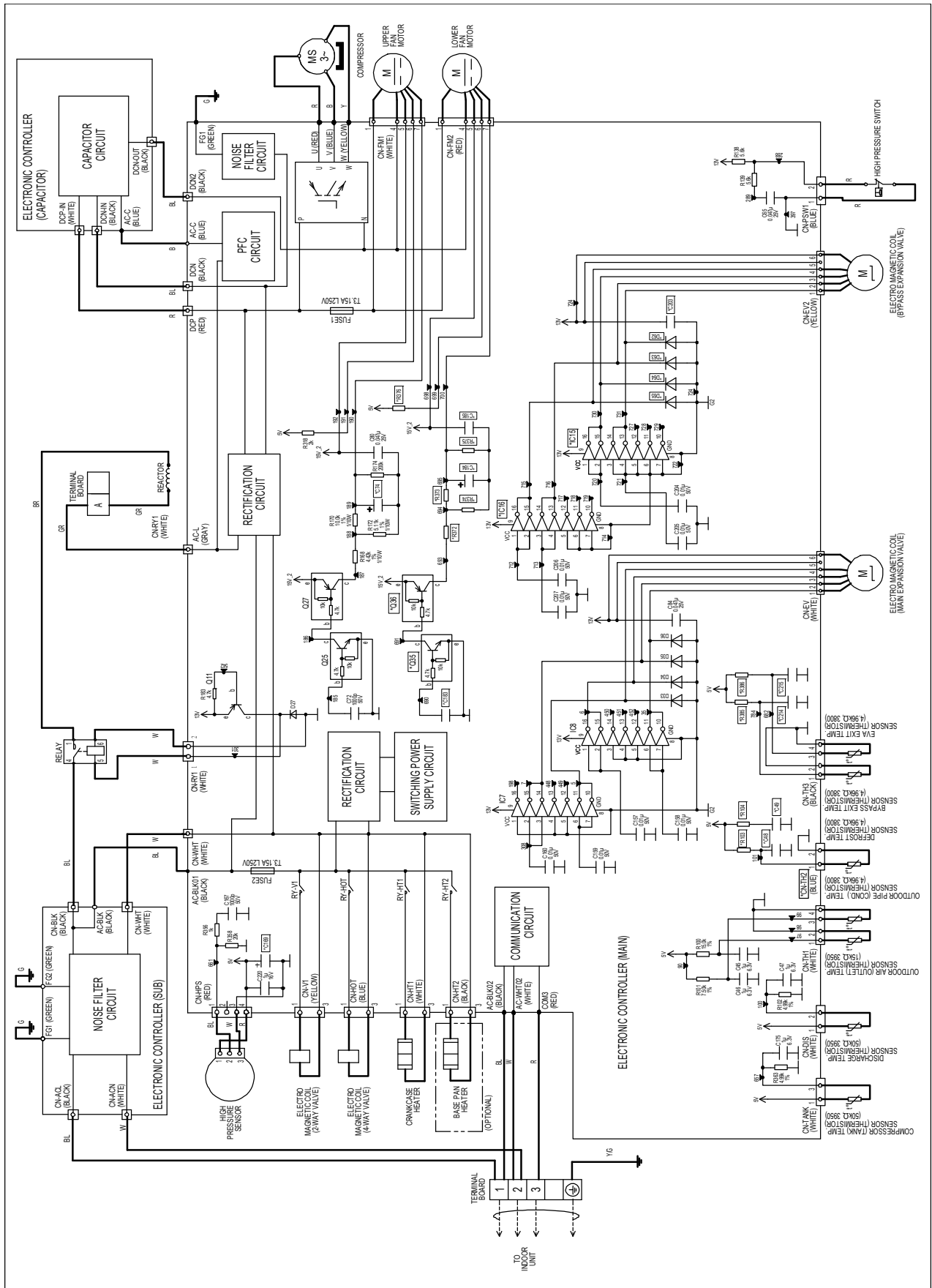

9.2.2 WH-UD12FE5 WH-UD16FE5

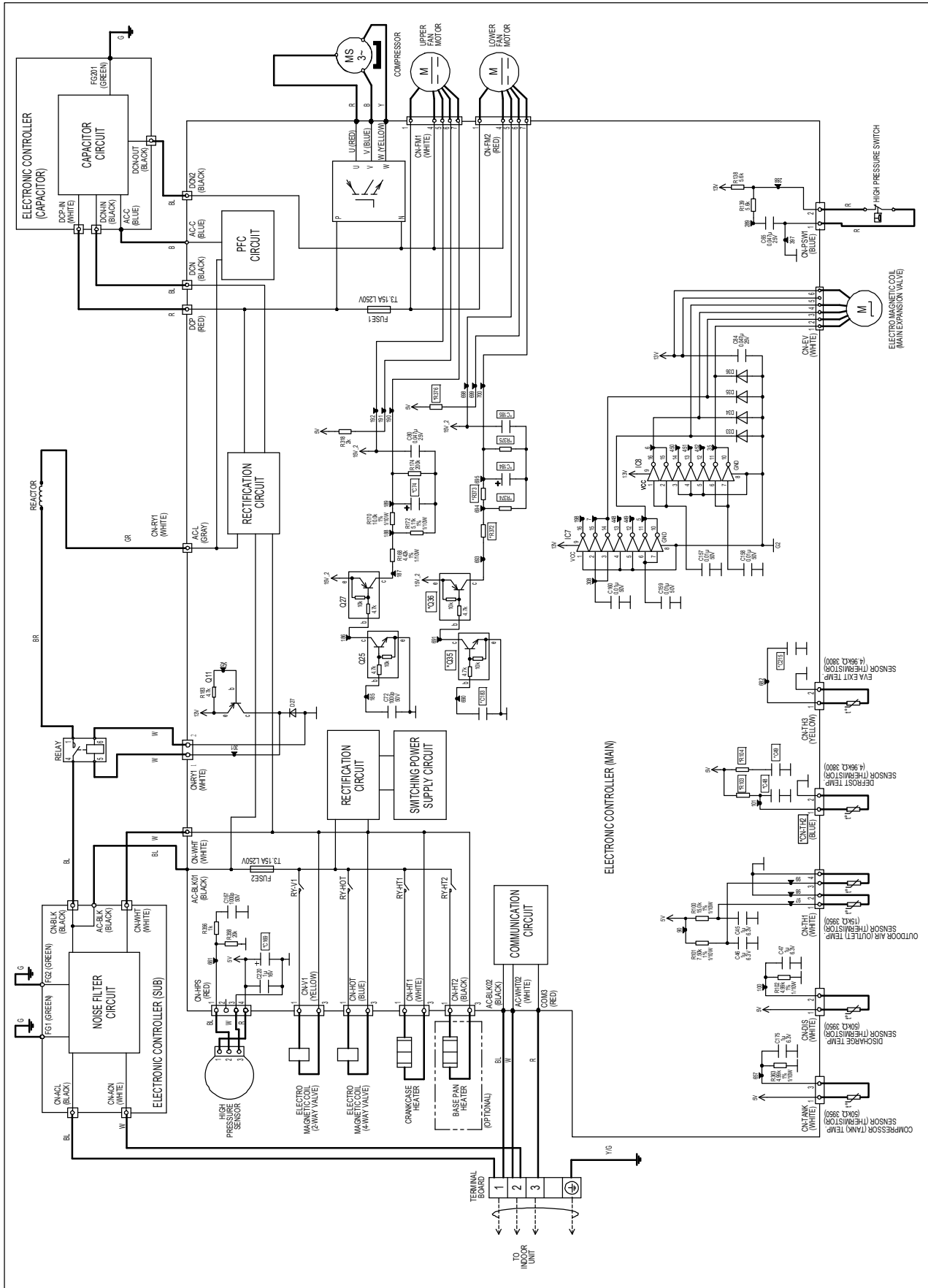

10.2 Outdoor Unit

10.2.1 Main Printed Circuit Board

10.2.1.1 WH-UX09FE5 WH-UX12FE5

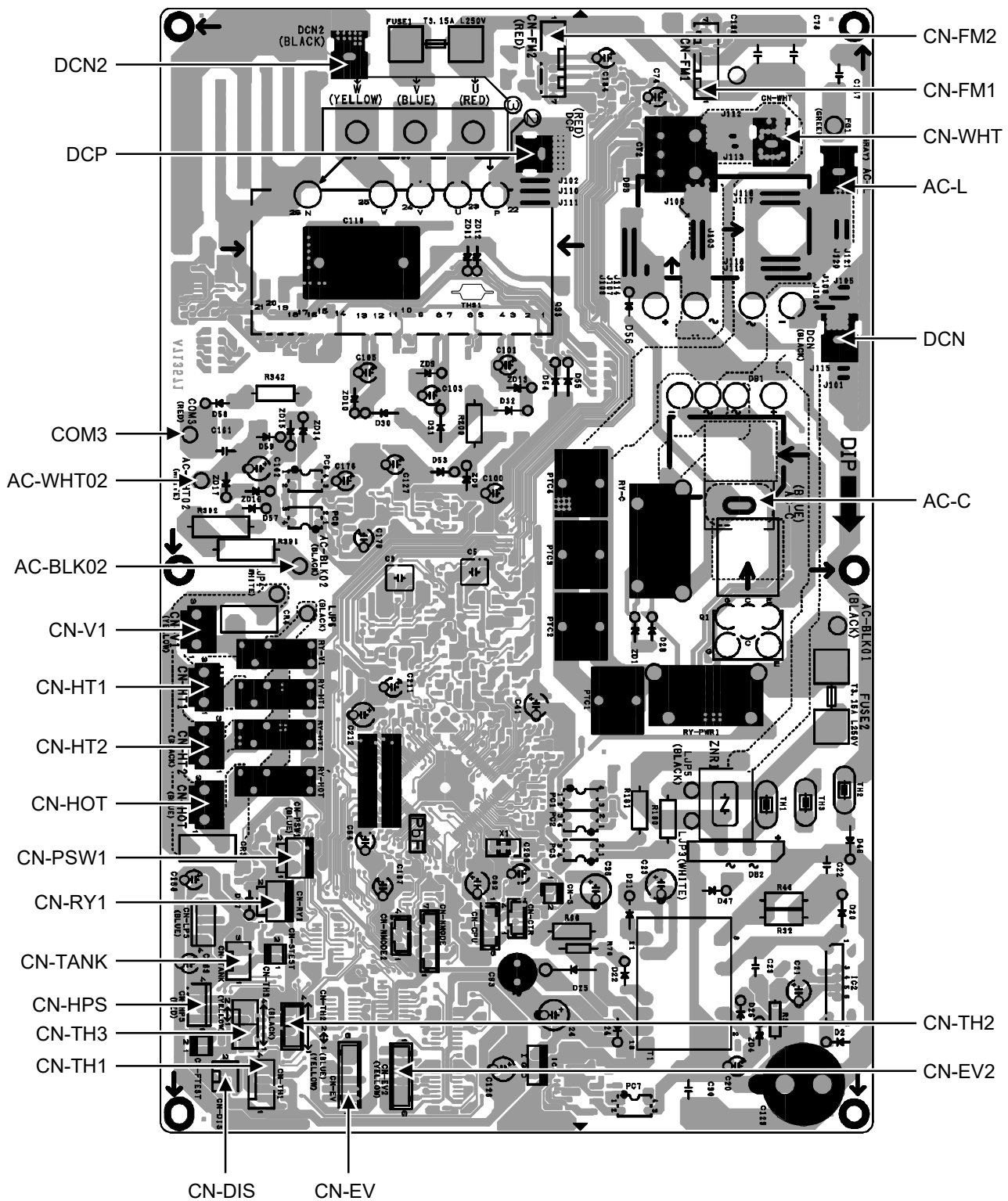

10.2.1.2 WH-UD12FE5 WH-UD16FE5

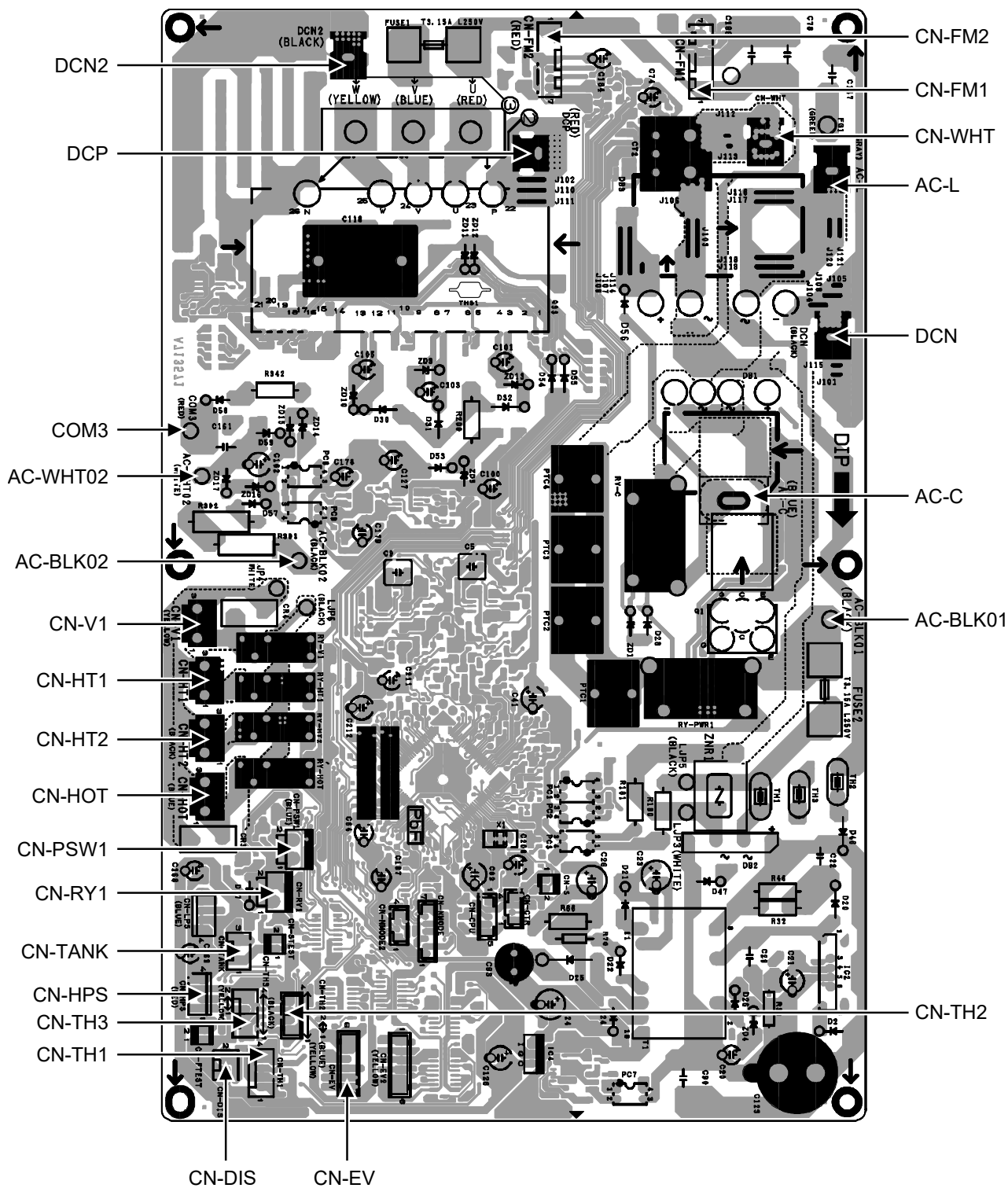

10.2.1.2.1 Noise Filter Printed Circuit Board

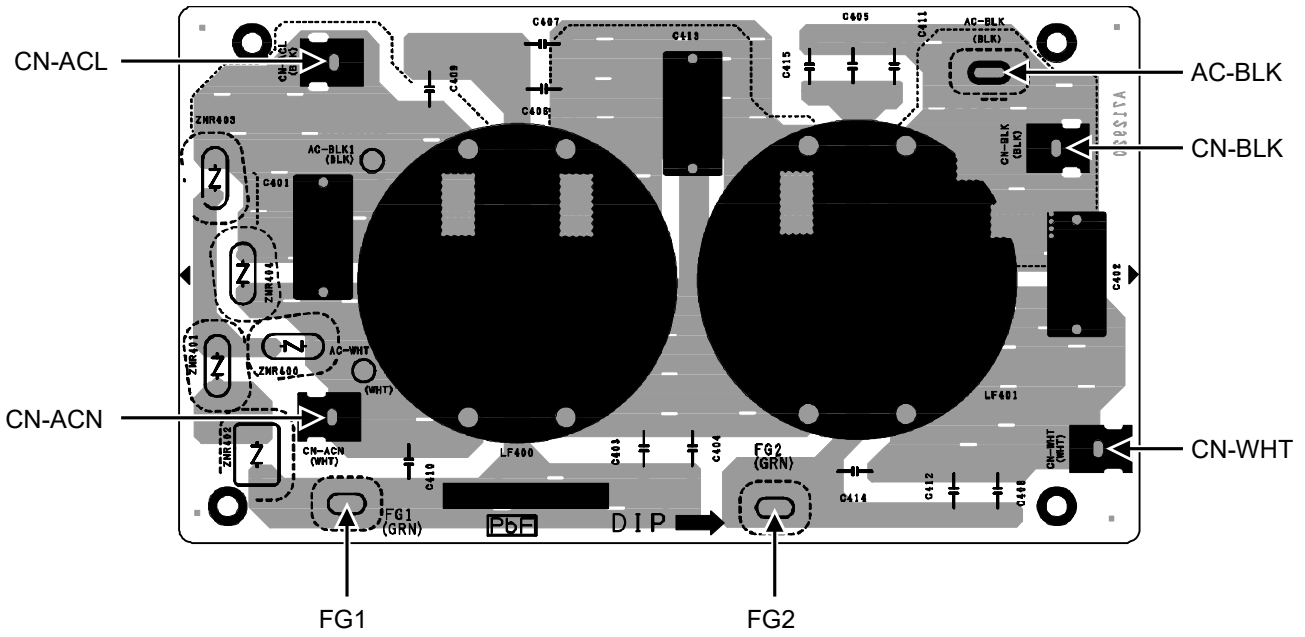

10.2.1.2.2 Capacitor Printed Circuit Board

10.2.1.2.2.1 WH-UX09FE5 WH-UX12FE5

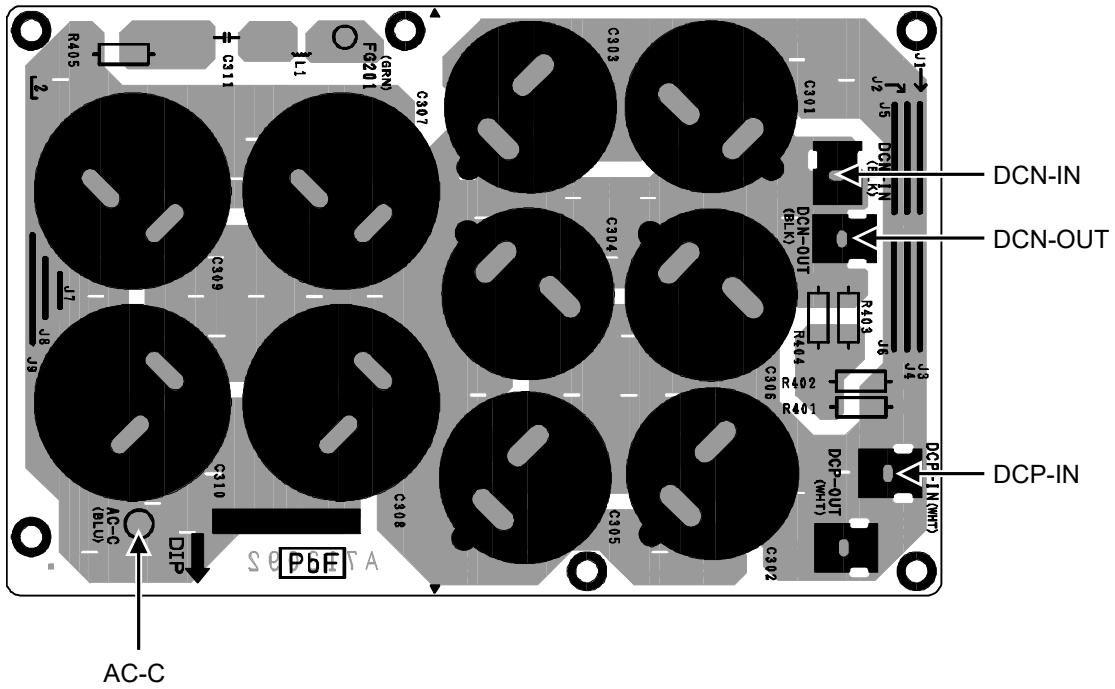

10.2.1.2.2 WH-UD12FE5 WH-UD16FE5

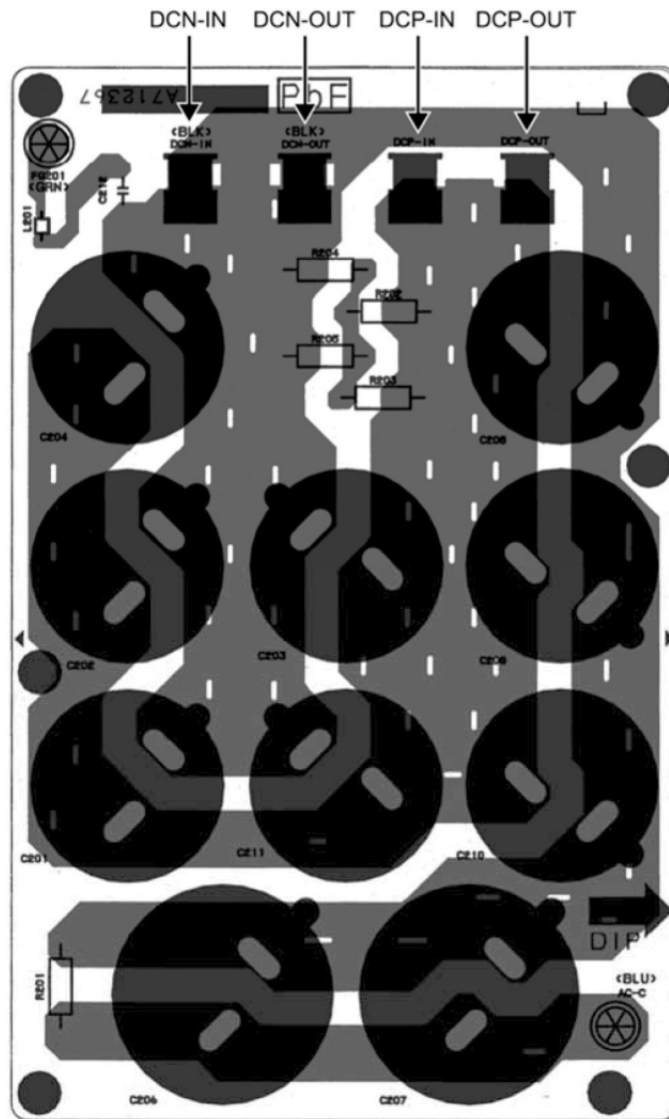

11. Installation Instruction

Field Supply Accessories

No.	Part	Qty.		Model	Specifications	Maker
i	2-way Valve Kit	1	Electromotoric Actuator	SFA21/18	AC230V	Siemens
			2-port Valve	VVI46/25	--	Siemens
ii	Room Thermostat	1	Analog Type	RAA20	AC230V	Siemens
			Programmable Type	REV200		

- It is recommended to purchase the field supply accessories from the specific maker whom listed in above table.

11.1 Indoor Unit

11.1.1 Select the Best Location

- Install the Tank Unit in indoors with frost free weather proof location only.
- Must install on a flat horizontal and solid hard surface.
- There should not be any heat source or steam near the Tank Unit.
- A place where air circulation in the room is good.
- A place where drainage can be easily done (e.g. Utility room).
- A place where Tank Unit's operation noise will not cause discomfort to the user.
- A place where Tank Unit is far from door way.
- A place where accessible for maintenance.
- Ensure to keep minimum distance of spaces as illustrated below from wall, ceiling, or other obstacles.
- A place where flammable gas leaking might not occur.
- Secure the Tank Unit to prevent it being knocked over accidentally or during earthquakes.

11.1.1.1 Required space for installation

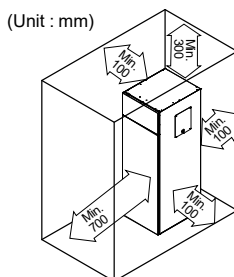

11.1.1.2 Transport and Handling

- Be careful during transporting the unit so that it is not damaged by impact.
- Only remove the packaging material once it has reached its desired installation location.
- It may need three or more people to carry out the installation work. The weight of Tank Unit might cause injury if carried by one person.
- The Tank Unit can be transported either in vertical or horizontal.
 - If transported in horizontal, make sure Front of packaging material (printed with "FRONT") must facing upwards.

- If transported in vertical, use the hand holes on sides, slide and move to the desired location.
- Fix the Adjustable Feet, if the Tank unit installed on an uneven surface.

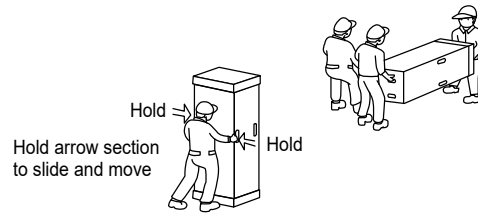

11.1.2 To Drill a Hole in the Wall and Install a Sleeve of Piping

- Make a $\varnothing 70$ mm through hole.
- Insert the piping sleeve to the hole.
- Fix the bushing to the sleeve.
- Cut the sleeve until it extrudes about 15 mm from the wall.

⚠ CAUTION	
!	When the wall is hollow, please be sure to use the sleeve for tube assembly to prevent dangers caused by mice biting the connection cable.

- Finish by sealing the sleeve with putty or caulking compound at the final stage.

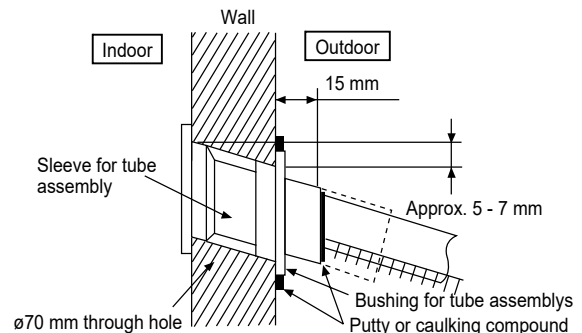

11.1.3 Piping Installation

11.1.3.1 Typical Piping Installation

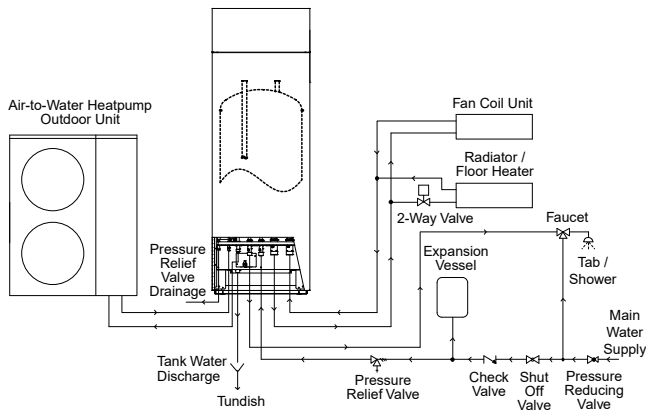

11.1.3.2 Access to Internal Components

⚠ WARNING

This section is for authorized and licensed electrician/water system installer only. Work behind the front plate secured by screws must only be carried out under supervision of qualified contractor, installation engineer or service person.

• Open and Close Top Front Plate

- 1 Do not open or close the top front cabinet by excessive force.
- 2 Follow below illustrations to open / close the Top Front Plate.

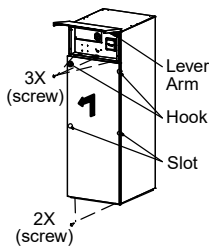
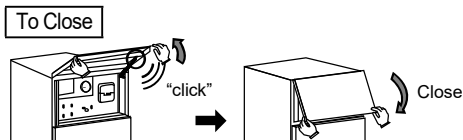
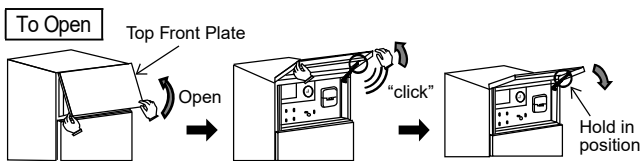

⚠ CAUTION

When open or close the Top Front Plate, make sure it is securely hold in position. Else, it may fall and injures the fingers or palms.

Open or close the Bottom Front Plate carefully. The heavy Bottom Front Plate may injures the fingers.

• Open and Close Bottom Front Panel

- 1 Must open the Top Front Plate before access Bottom Front Plate.
- 2 Remove the 5 mounting screws of Bottom Front Plate.
- 3 Slide it upwards to unhook the Bottom Front Plate hooks and slots.
- 4 Reverse above steps 1~3 for close it.

11.1.3.3 Refrigerant Piping Installation

This Tank Unit is designed for combination with Panasonic Air-to-Water Heat Pump Outdoor Unit. If Outdoor Unit from other manufacturer are being used in combination with Panasonic Tank Unit, optimum operation and reliability of the system is not guaranteed. Thus warranty cannot be given in such case.

- 1 Connect Tank Unit to Air-to-Water Heatpump Outdoor Unit with correct piping size.

Model		Piping size (Torque)	
Tank Unit	Outdoor Unit	Gas	Liquid
ADC1216*E5*	UX09*E5* / UX12*E5* / UD12*E5* / UD16*E5*	ø15.88mm (5/8") [65 N•m]	ø9.52mm (3/8") [42 N•m]

⚠ CAUTION

Do not overtighten, overtightening may cause gas leakage.

- 2 Please make flare after inserting flare nut (located at joint portion of tube assembly) onto the copper pipe. (In case of using long piping)
- 3 Do not use pipe wrench to open refrigerant piping. Flare nut may be broken and cause leakage. Use proper spanner or ring wrench.
- 4 Connect the piping:
 - Align the centre of piping and sufficiently tighten the flare nut with fingers.
 - Further tighten the flare nut with torque wrench in specified torque as stated in the table.

11.1.3.3.1 Cutting and Flaring the Piping

- 1 Please cut using pipe cutter and then remove the burrs.
- 2 Remove the burrs by using reamer. If burrs is not removed, gas leakage may be caused. Turn the piping end down to avoid the metal powder entering the pipe.
- 3 Please make flare after inserting the flare nut onto the copper pipes.

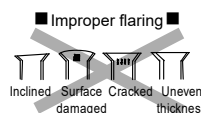
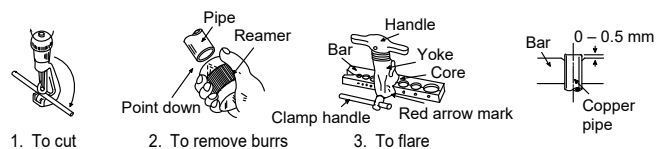

When properly flared, the internal surface of the flare will evenly shine and be of even thickness. Since the flare part comes into contact with the connections, carefully check the flare finish.

11.1.3.4 Water Piping Installation

- Please engage a licensed water circuit installer to install this water circuit.
- This water circuit must comply with relevant European and national regulations (including EN61770), and local building regulation codes.
- The minimum requirement of water in the system is 50 litres. If this value could not be achieved, please install additional buffer tank (field supply).
- Ensure the components installed in the water circuit could withstand water pressure during operation.
- Do not use worn out tube.
- Do not apply excessive force to pipes that may damage the pipes.
- Choose proper sealer which can withstand the pressures and temperatures of the system.
- Make sure to use two spanners to tighten the connection. Further tighten the nuts with torque wrench in specified torque as stated in the table.
- Cover the pipe end to prevent dirt and dust when inserting it through a wall.
- Choose proper sealer which can withstand the pressures and temperatures of the system.
- If non-brass metallic piping is used for installation, make sure to insulate the pipes to prevent galvanic corrosion.
- Use correct nut for all Tank Unit tube connections and clean all tubes with tap water before installation. See Tube Position Diagram for detail.

Tube Connector	Nut Size	Torque
Ⓐ & Ⓑ	RP 1¼"	117.6 N•m
Ⓒ & Ⓓ	RP ¾"	58.8 N•m

⚠ CAUTION

Do not overtighten, overtightening may cause water leakage.

- Make sure to insulate the water circuit pipes to prevent reduction of heating capacity.
- After installation, check the water leakage condition in connection area during test run.
- Failure to connect the tube appropriately might cause the Tank Unit malfunction.
- Protection From Frost:
If the Tank Unit is being exposed to frost while power supply failure or pump operating failure, drain the system. When water is idle inside the system, freezing up is very likely to happen which could damage the system. Make sure the power supply is turned off before draining. Heater Assembly may be damaged under dry heating.
- Corrosion Resistance:
Duplex stainless steel is naturally corrosion resistant to mains water supply. No specific maintenance is required to maintain this resistance. However, please note that Tank Unit is not guaranteed for use with a private water supply.
- It is recommended to use a tray (field supply) to collect water from the Tank Unit if water leakage occur.

(A) Space Heating/Cooling Pipework

- Connect Tank Unit Tube Connector Ⓐ to outlet connector of Panel/Floor heater.
- Connect Tank Unit Tube Connector Ⓑ to inlet connector of Panel/Floor heater.
- Failure to connect the tube appropriately might cause the Tank Unit malfunction.
- Refer below table for the rated flow rate of each particular Outdoor Unit.

Model		Rated Flow Rate (L/min)	
Tank Unit	Outdoor Unit	Cool	Heat
ADC1216*E5*	UX09*E5*	20.1	25.8
	UX12*E5*	28.7	34.4
	UD12*E5*	28.7	34.4
	UD16*E5*	35.0	45.9

(B) Domestic Hot Water Tank Pipework

- It's strongly recommended to install an expansion vessel (field supply) in the Domestic Hot Water Tank circuit. Refer Typical Piping Installation section to locate the expansion vessel.
 - Recommended pre-charge pressure of the expansion vessel (field supply) = 0.35MPa (3.5 bars)
- In high water pressure or water supply is above 500kPa, please install the Pressure Reducing Valve for water supply. If the pressure higher than that, it might damage the Tank Unit.
- A Pressure Reducing Valve (field supply) and Pressure Relief Valve (field supply) with below specification is strongly advised to be installed along the line of the tube connector Ⓐ of Tank Unit. Refer Typical Piping Installation section to locate both of these valves.
- Recommended Pressure Reducing Valve specifications:
 - Set pressure: 0.35 MPa (3.5 bars)
- Recommended Pressure Relief Valve specifications:
 - Set pressure: 1.0 MPa (10.0 bars)
- Must connect a faucet to Tank Unit Tube Connector Ⓒ and main water supply, in order to supply water with appropriate temperature for shower or tap usage. Failure to do so might cause scalding.
- Failure to connect the tube appropriately might causing the Tank Unit malfunction.

(C) Pressure Relief Valve Drainage Pipework

- Connect a drain hose with inner diameter of 15 mm to Pressure Relief Valve Drainage Ⓕ.
- The hose must be installed in a continuously downward direction and left open to the frost-free atmosphere.
- If drain hose is long, use a metal support fixture along the way to eliminate the wavy pattern of drain tube.
- The water may drip from this discharge hose. Therefore must guide the hose without close or block the outlet of the hose.

- Do not insert this hose into sewage hose or cleaning hose that may generate ammonia gas, sulphuric gas etc.
- If necessary, use a hose clamp to tighten the hose at drain hose connector to prevent it from leaking.
- Guide the drain hose to outdoor as illustrated at the right figure.

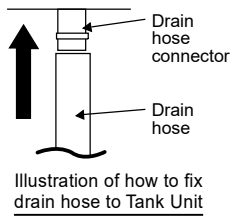

(D) Domestic Hot Water Tank Discharge Pipework

- Use R $\frac{1}{2}$ " male connector for Domestic Hot Water Tank Discharge ⑨ connection.
- Piping must be installed in a continuously downward direction and in a frost-free environment.
- Discharge pipes must be visible and away from electrical components.
- Guide the drain hose to outdoor as illustrated at the below figure.
- It is recommended to fit a tundish into this ⑨ pipework. Tundish should be visible and positioned away from frost environment and electrical components.

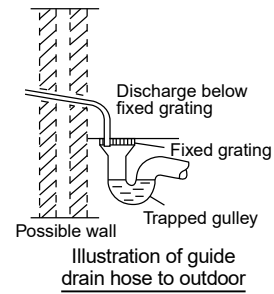

(E) Drain Elbow and Hose Installation

- Fix the Drain Elbow and Packing to the bottom of Drain Water Hole ①.
- Use inner diameter 17 mm drain hose in the market.
- This hose must be installed in a continuously downward direction and in a frost-free environment.
- Guides this hose outlet to outdoor only.
- Do not insert this hose into sewage or drain pipe that may generate ammonia gas, sulphuric gas, etc.
- If necessary, use hose clamp to further tighten the hose at drain hose connector to prevent leakage.
- Water will drip from this hose, therefore the outlet of this hose must be installed in an area where the outlet cannot become blocked.

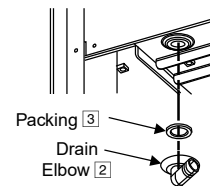

11.1.4 Connect the Cable to Tank Unit

⚠ WARNING

This section is for authorized and licensed electrician only. Work behind the Control Board Cover secured by screws must only be carried out under supervision of qualified contractor, installation engineer or service person.

11.1.4.1 Fixing of Power Supply Cable and Connecting Cable

- 1 Connecting cable between Tank Unit and Outdoor Unit shall be approved polychloroprene sheathed flexible cord, type designation 60245 IEC 57 or heavier cord. See below table for cable size requirement.

Model		Connecting Cable Size
Tank Unit	Outdoor Unit	
ADC1216*E5*	UX09*E5* / UX12*E5* / UD12*E5* / UD16*E5*	4 x 4.0 mm ²

- Ensure the colour of wires of Outdoor Unit and the terminal no. are the same to the Tank Unit respectively.
- Earth wire shall be longer than the other wires as shown in the figure for the electrical safety in case of the slipping out of the cord from the Holder (Clamper).

- 2 An isolating device must be connected to the power supply cable.
 - Isolating device (disconnecting means) should have minimum 3.0 mm contact gap.
 - Connect the approved polychloroprene sheathed power supply 1 cord and power supply 2 cord and type designation 60245 IEC 57 or heavier cord to the terminal board, and to the other end of the cord to isolating device (Disconnecting means). See below table for cable size requirement.

Model		Power Supply Cord	Cable Size	Isolating Devices	Recommended RCD
Tank Unit	Outdoor Unit				
ADC1216*E5*	UX09*E5* / UX12*E5* / UD12*E5* / UD16*E5*	1	3 x 4.0 mm ²	30A	40mA, 2P, type A
		2	3 x 4.0 mm ²	30A	40mA, 2P, type AC

- 3 To avoid the cable and cord being damaged by sharp edges, the cable and cord must be passed through a bushing (located at the bottom of Control Board) before terminal board. The bushing must be used and must not be removed.

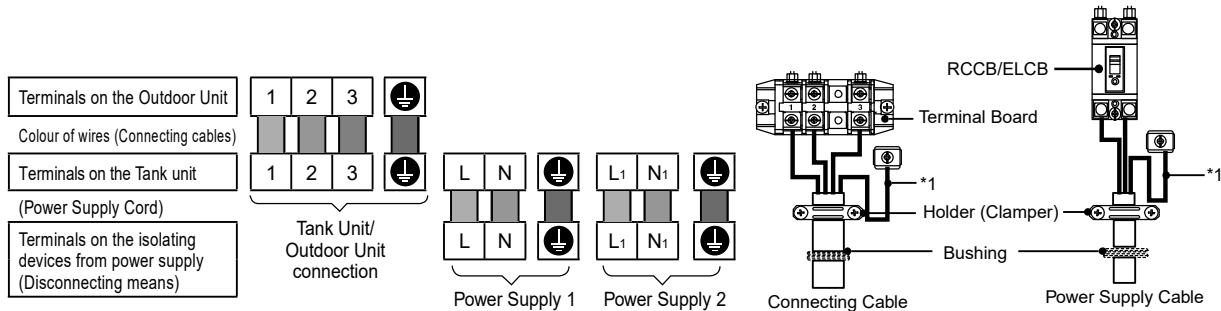

Terminal screw	Tightening torque N•cm {kgf•cm}
M4	157~196 {16~20}
M5	196~245 {20~25}

*1 - Earth wire must be longer than other cables for safety reasons

11.1.4.2 Connecting with external device (optional)

- 1 All connections shall follow to the local national wiring standard.
- 2 It is strongly recommended to use manufacturer-recommended parts and accessories for installation.
- 3 Two-way Valve shall be spring and electronic type, refer to “Field Supply Accessories” table for details. Valve cable shall be (3 x min 0.5 mm²), of type designation 60245 IEC 57 or heavier, or similarly double insulation sheathed cable.
 - * note: - Two-way Valve shall be CE marking compliance component.
 - Maximum load for the valve is 9.8VA.
- 4 Room Thermostat cable must be (4 or 3 x min 0.5 mm²), double insulation layer of PVC-sheathed or rubber-sheathed cable.
- 5 External Controller shall be connected to 1-pole switch with min 3.0mm contact gap. (connection refer to Diagram 4.1). Its cable must be (2 x min 0.5 mm²), double insulation layer of PVC-sheathed or rubber-sheathed cable.
 - * note: - When making such connection, kindly remove the jumper between terminal no. 4 and 5.
 - Switch used shall be CE compliance component.
 - Maximum operating current shall be less than 3A_{rms}.

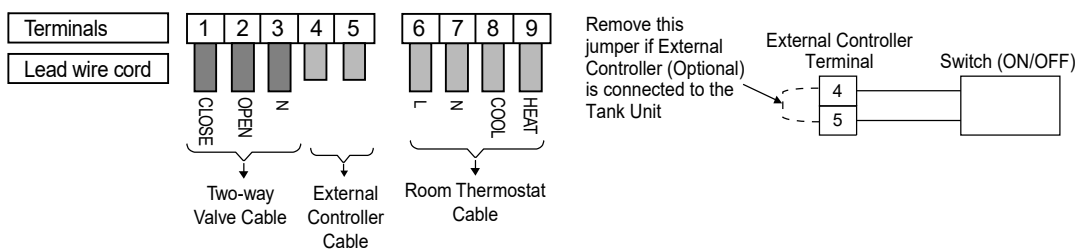
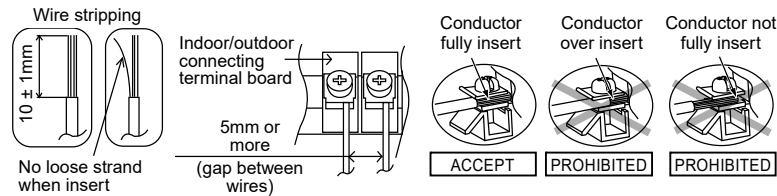

Diagram 4.1: External Controller connecting diagram

11.1.4.3 Wire Stripping and Connecting Requirement



11.1.4.4 Connecting Requirement

For Tank Unit with UX09*E5* / UX12*E5* / UD12*E5* / UD16*E5*

- This equipment's Power Supply 1 complies with IEC61000-3-12 provided that the short circuit power S_{sc} is greater than or equal to 1800kW at the interface point between the user's supply and the public system. It is the responsibility of the installer or user of the equipment to ensure, by consultation with the distribution network operator if necessary, that the equipment is connected only to a supply with a short circuit power S_{sc} greater than or equal to 1800kW.
- The equipment's Power Supply 1 shall be connected to a suitable supply network, having services current capacity $\geq 100A$ per phase. Please liaise with supply authority that the service current capacity at the interface point is sufficient for the installation of the equipment.
- The equipment's Power Supply 2 complies with IEC/EN 61000-3-12.
- The equipment's Power Supply 2 shall be connected to suitable supply network, with the following maximum permissible system impedance Z_{max} at the interface of the point: 0.357Ω . Please liaise with supply authority to ensure that the Power Supply 2 is connected only to a supply of that impedance or less.

11.1.5 Charging and Discharging the Water

- Make sure all the piping installations are properly done before carry out below steps.

11.1.5.1 Charge the Water

- **For Domestic Hot Water Tank**
 - 1 Set the Domestic Hot Water Tank Discharge Valve ⑨ to "CLOSE".

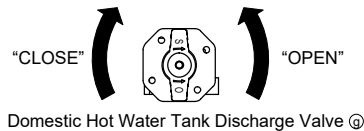

- 2 Set all Tap / Shower "OPEN".
- 3 Start filling water to the Domestic Hot Water Tank via Tube Connector ③. After 20~40min, water should flow out from Tap / Shower. Else, please contact your local authorized dealer.
- 4 Check and make sure no water leaking at the tube connecting points.

- **For Space Heating / Cooling**

- 1 Turn the plug on the Air Purge Valve outlet anticlockwise by one complete turn from fully closed position.

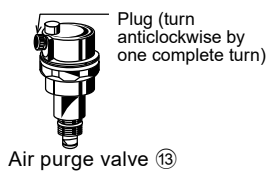

- 2 Set the Pressure Relief Valve level "DOWN".

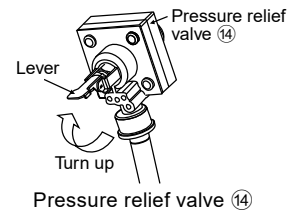



- 3 Start filling water (with pressure more than 0.1 MPa (1 bar)) to the Space Heating / Cooling circuit via Tube Connector ②. Stop filling water if the free water flow through Pressure Relief Valve Drainage ④.
- 4 Turn ON the Tank Unit and make sure Water Pump is running.
- 5 Check and make sure no water leaking at the tube connecting points.

11.1.5.2 Discharge the Water

- **For Domestic Hot Water Tank**
 - 1 Turn OFF power supply.
 - 2 Set the Domestic Hot Water Tank Discharge Valve ⑨ to "OPEN".
 - 3 Open Tap / Shower to allow air inlet.
 - 4 After discharge, set Hot Water Tank Discharge Valve ⑨ to "CLOSE".

11.2 Outdoor Unit

Attached accessories

No.	Accessories part	Qty.	No.	Accessories part	Qty.
1	Drain elbow 	1	3	Protective bushing 	2
2	Rubber cap 	8			

Optional Accessory

No.	Accessories part	Qty.
4	Base Pan Heater CZ-NE3P	1

- It is strongly recommended to install a Base Pan Heater (optional) if the outdoor unit is installed in a cold climate area. Refer the Base Pan Heater (optional) installation instruction for details of installation.

11.2.1 Select the Best Location

- If an awning is built over the unit to prevent direct sunlight or rain, be careful that heat radiation from the condenser is not obstructed.
- Avoid installations in areas where the ambient temperature may drop below -20°C.
- Keep the spaces indicated by arrows from wall, ceiling, fence or other obstacles.
- Do not place any obstacles which may cause a short circuit of the discharged air.
- If outdoor unit installed near sea, region with high content of sulphur or oily location (e.g. machinery oil, etc), its lifespan may be shortened.
- When installing the product in a place where it will be affected by typhoon or strong wind such as wind blowing between buildings, including the rooftop of a building and a place where there is no building in surroundings, fix the product with an overturn prevention wire, etc. (Overturn prevention fitting model number: K-KYZP15C)

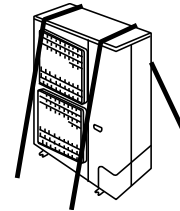

- If piping length is over 10 m, additional refrigerant should be added as shown in the table.

Model	Piping size		Rated Length (m)	Max. Elevation (m)	Min. Piping Length (m)	Max. Piping Length (m)	Additional Refrigerant (g/m)
	Gas	Liquid					
UX09*E5*, UX12*E5*, UD12*E5*, UD16*E5*, UX09*E8*, UX12*E8*, UX16*E8*, UD09*E8*, UD12*E8*, UD16*E8*	ø15.88mm (5/8")	Ø9.52mm (3/8")	5	20	3	30	50

Example:

If piping length is 30m, the quantity of additional refrigerant should be 1000g. [(30-10)m x 50 g/m = 1000g]

11.2.2 Install the Outdoor Unit

11.2.2.1 Installation Diagram

- It is advisable to avoid more than 2 blockage directions. For better ventilation & multiple-outdoor installation, please consult authorized dealer/specialist.
- This illustration is for explanation purposes only.

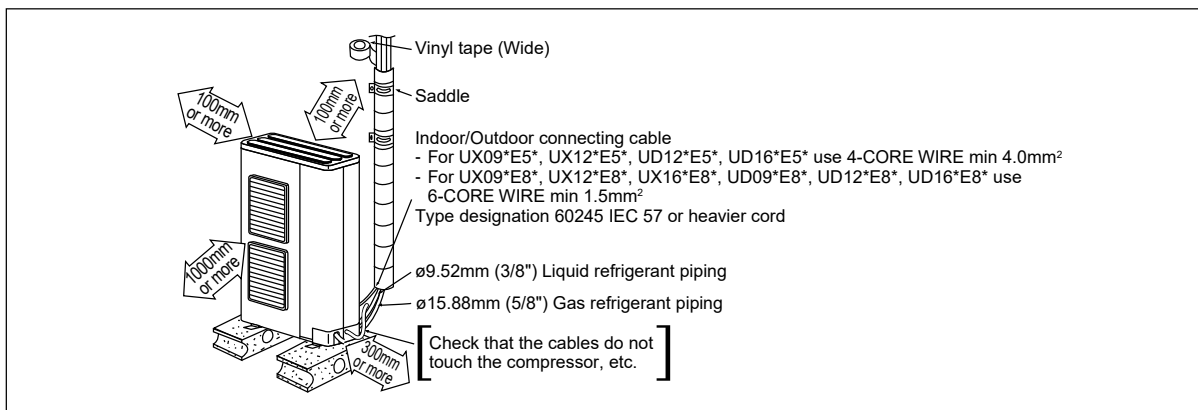

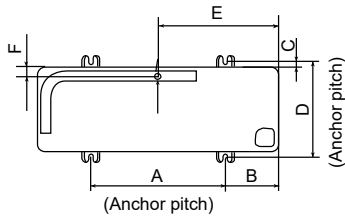

Model	A	B	C	D	E	F
UX09*E5*, UX12*E5*, UD12*E5*, UD16*E5*, UX09*E8*, UX12*E8*, UX16*E8*, UD09*E8*, UD12*E8*, UD16*E8*	620	140	15	355	450	44

(Unit : mm)

- After selecting the best location, start installation according to Installation Diagram.
 - Fix the unit on concrete or rigid frame firmly and horizontally by bolt nut ($\phi 10$ mm).
 - When installing at roof, please consider strong wind and earthquake. Please fasten the installation stand firmly with bolt or nails.

11.2.2.2 Disposal of Outdoor Unit Drain Water

- When a Drain elbow is used, please ensure to follow below:
 - the unit should be placed on a stand which is taller than 50 mm.
 - cover the $\phi 20$ mm holes with Rubber cap (refer to illustration below).
 - use a tray (field supply) when necessary to dispose the outdoor unit drain water.
- If the unit is used in an area where temperature falls below 0°C for 2 or 3 consecutive days, it is recommended not to use the Drain elbow and Rubber cap, for the drain water freezes and the fan will not rotate.

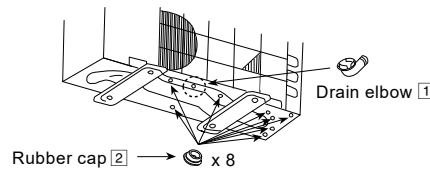

11.2.3 Connecting the Piping

⚠ CAUTION

Do not over tighten, over tightening may cause gas leakage.

Model	Piping size (Torque)	
	Gas	Liquid
UX09*E5*, UX12*E5*, UD12*E5*, UD16*E5*, UX09*E8*, UX12*E8*, UX16*E8*, UD09*E8*, UD12*E8*, UD16*E8*	$\phi 15.88\text{mm}$ (5/8") [65 N•m]	$\phi 9.52\text{mm}$ (3/8") [42 N•m]

11.2.3.1 Connecting the Piping to Outdoor Unit

Decide piping length and then cut by using pipe cutter. Remove burrs from cut edge. Make flare after inserting the flare nut (locate at valve) onto the copper pipe. Align center of piping to valves and then tighten with torque wrench to the specified torque as stated in the table.

Local pipes can project in any of four directions.

- Make holes in the pipe panels for the pipes to pass through.
- Be sure to install the pipe panels to prevent rain from getting inside the outdoor unit. [Removing the service panel].
 - Remove the three mounting screws.
 - Slide the service panel downward to release the pawls.

After this, pull the service panel toward you to remove it.

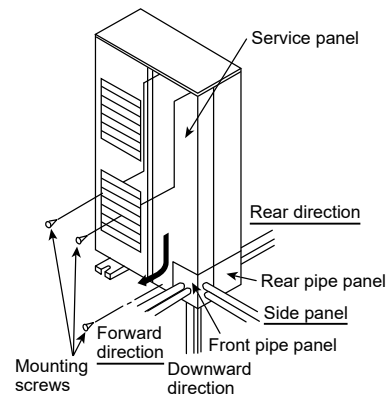

Be sure to use two spanners to tighten.
(If the nuts are overtightened, it may cause the flares to break or leak.)

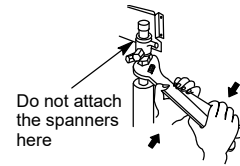

Close the tube joining area with putty heat insulator (local supply) without any gap as shown in right figure.
(To prevent insects or small animal entering.)

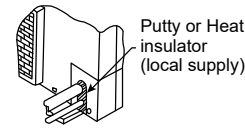

11.2.3.1.1 Cutting and Flaring the Piping

- 1 Please cut using pipe cutter and then remove the burrs.
- 2 Remove the burrs by using reamer. If burrs is not removed, gas leakage may be caused. Turn the piping end down to avoid the metal powder entering the pipe.
- 3 Please make flare after inserting the flare nut onto the copper pipes.

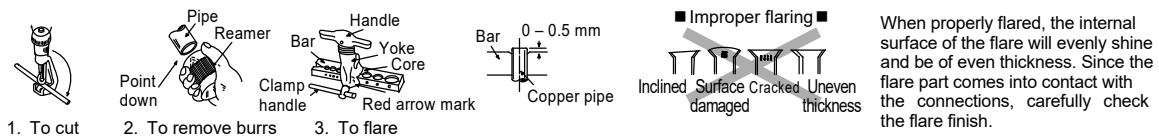

11.2.4 Evacuation of the Equipment

WHEN INSTALLING AN AIR-TO-WATER HEAT PUMP, BE SURE TO EVACUATE THE AIR INSIDE THE UNIT AND PIPES in the following procedure.

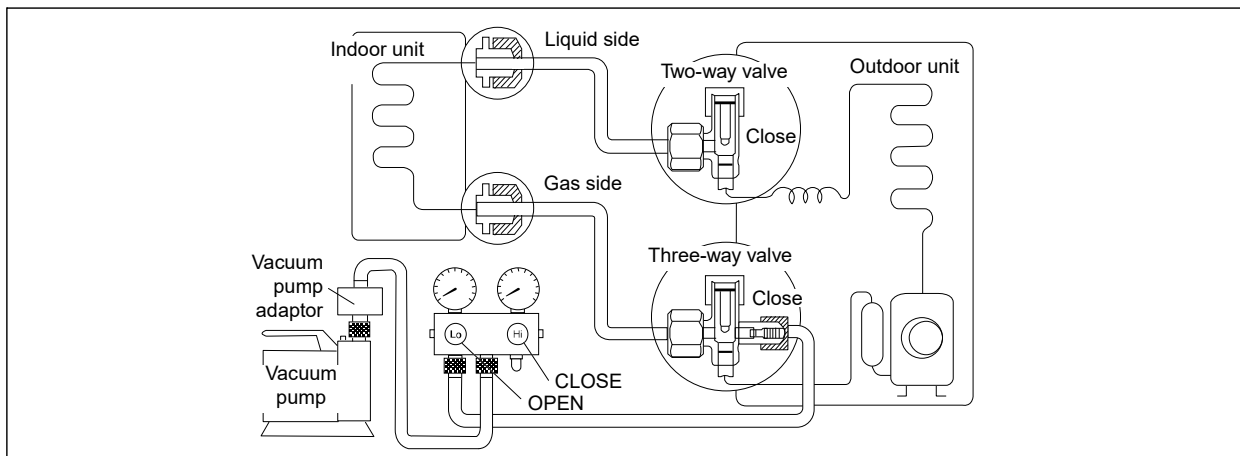

- 1 Connect a charging hose with a push pin to the Low side of a charging set and the service port of the 3-way valve.
 - Be sure to connect the end of the charging hose with the push pin to the service port.
- 2 Connect the center hose of the charging set to a vacuum pump with check valve, or vacuum pump and vacuum pump adaptor.
- 3 Turn on the power switch of the vacuum pump and make sure that the needle in the gauge moves from 0 cmHg (0 MPa) to -76 cmHg (-0.1 MPa). Then evacuate the air approximately ten minutes.
- 4 Close the Low side valve of the charging set and turn off the vacuum pump. Make sure that the needle in the gauge does not move after approximately five minutes.

Note : BE SURE TO FOLLOW THIS PROCEDURE IN ORDER TO AVOID REFRIGERANT GAS LEAKAGE.
- 5 Disconnect the charging hose from the vacuum pump and from the service port of the 3-way valve.
- 6 Tighten the service port caps of the 3-way valve at a torque of 18 N•m with a torque wrench.
- 7 Remove the valve caps of both of the 2-way valve and 3-way valve. Position both of the valves to "OPEN" using a hexagonal wrench (4 mm).
- 8 Mount valve caps onto the 2-way valve and the 3-way valve.
 - Be sure to check for gas leakage.

⚠ CAUTION

If gauge needle does not move from 0 cmHg (0 MPa) to -76 cmHg (-0.1 MPa), in step ③ above take the following measure:

1. If the leak stops when the piping connections are tightened further, continue working from step ③.
2. If the leak does not stop when the connections are retightened, repair location of leak.
3. Do not release refrigerant during piping work for installation and reinstallation. Take care of the liquid refrigerant, it may cause frostbite.

11.2.5 Connect the Cable to the Outdoor Unit

(FOR DETAIL REFER TO WIRING DIAGRAM AT UNIT)

- 1 Remove the control board cover from the unit by loosening the screw.
- 2 Connecting cable between indoor unit and outdoor unit shall be approved polychloroprene sheathed flexible cable (see below table), type designation 60245 IEC 57 or heavier cable.
- 3 Secure the cable onto the control board with the holder (clammer).
- 4 Attach the control board cover back to the original position with screw.

⚠ WARNING

⚡ This equipment must be properly earthed.

Models	Flexible cable specification
UX09*E5*/UX12*E5*/ UD12*E5*/UD16*E5*	4 x min 4.0 mm ²

Terminals on the indoor unit	1	2	3	
Colour of wires				
Terminals on the outdoor unit	1	2	3	

Earth Wire must be longer than others cables for safety reason.

Models	Flexible cable specification
UX09*E8*, UX12*E8*, UX16*E8*, UD09*E8*, UD12*E8*, UD16*E8*	6 x min 1.5 mm ²

Terminals on the indoor unit	1	2	3	4	5	
Colour of wires						
Terminals on the outdoor unit	1	2	3	4	5	

Earth Wire must be longer than others cables for safety reason.

⚠ CAUTION

- For three phase model never operate the unit by pressing the electromagnetic switch.
- Never correct the phase by switching over any of the wires inside the unit.

- Select required direction and apply protective bushing provided in accessories to protect cables from sharp edges.
- Once all wiring work has been completed, tie the cable and cord together with the binding strap so that they do not touch other parts such as the compressor and bare copper pipes.

Outdoor Unit

DETAIL OF CONNECTING CABLE GUIDING

Protective bushing ③ Selection of direction

Apply cut

11.2.5.1 Wire Stripping and Connecting Requirement

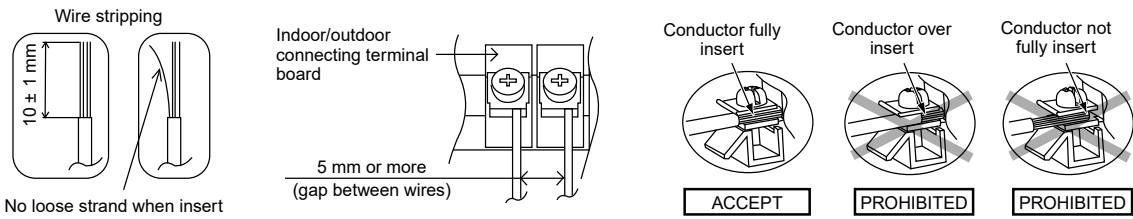

11.2.6 Pipe Insulation

- 1 Please carry out insulation at pipe connection portion as mentioned in Indoor/Outdoor Unit Installation Diagram. Please wrap the insulated piping end to prevent water from going inside the piping.
- 2 If drain hose or connecting piping is in the room (where dew may form), please increase the insulation by using POLY-E FOAM with thickness 6 mm or above.

12. Operation and Control

12.1 Basic Function

Inverter control, which equipped with a microcomputer in determining the most suitable operating mode as time passes, automatically adjusts output power for maximum comfort always. In order to achieve the suitable operating mode, the microcomputer maintains the set temperature by measuring the temperature of the environment and performing temperature shifting. The compressor at outdoor unit is operating following the frequency instructed by the microcomputer at indoor unit that judging the condition according to internal water setting temperature and water outlet temperature.

12.1.1 Internal Water Setting Temperature

Once the operation starts, control panel setting temperature will be taken as base value for temperature shifting processes. These shifting processes are depending on the Air-to-Water Heat pump settings and the operation environment. The final shifted value will be used as internal water setting temperature and it is updated continuously whenever the electrical power is supplied to the unit.

12.1.2 Heating Operation

12.1.2.1 Thermostat Control

- Compressor is OFF when Water Outlet Temperature – Internal Water Setting Temperature > 2°C for continuously 3 minutes.
- Compressor is ON after waiting for 3 minutes, if the Water Outlet Temperature – Water Inlet Temperature (temperature at thermostat OFF is triggered) < -3°C.

12.1.2.2 Thermostat Control (Outdoor Ambient Temperature)

Stops provide heating to room side during high outdoor ambient condition.

Control content:

- Heating operation and water pump will turn OFF when outdoor ambient temperature > outdoor thermo off temperature + 3°C.
(Outdoor thermo off set temperature is set by control panel. Thermo off set temperature is between 5°C ~ 35°C)
- Heating operation will resume when Outdoor ambient temperature < Outdoor thermo OFF set temperature + 1°C.

12.1.2.3 Heat Mode Operation

Operation of heat pump provide heating capacity to room side by hot water through heating panel, floor heating or fan coil unit.

- 1 3 ways valve control:
 - 3 ways valve switch and fix to heating side.
- 2 Heat pump operates follow normal heating operation.
- 3 Back up heater operate follow normal operation.
- 4 2 ways valve control:
 - 2 ways valve opens.

Heat Mode Operation Time Chart

Exp:

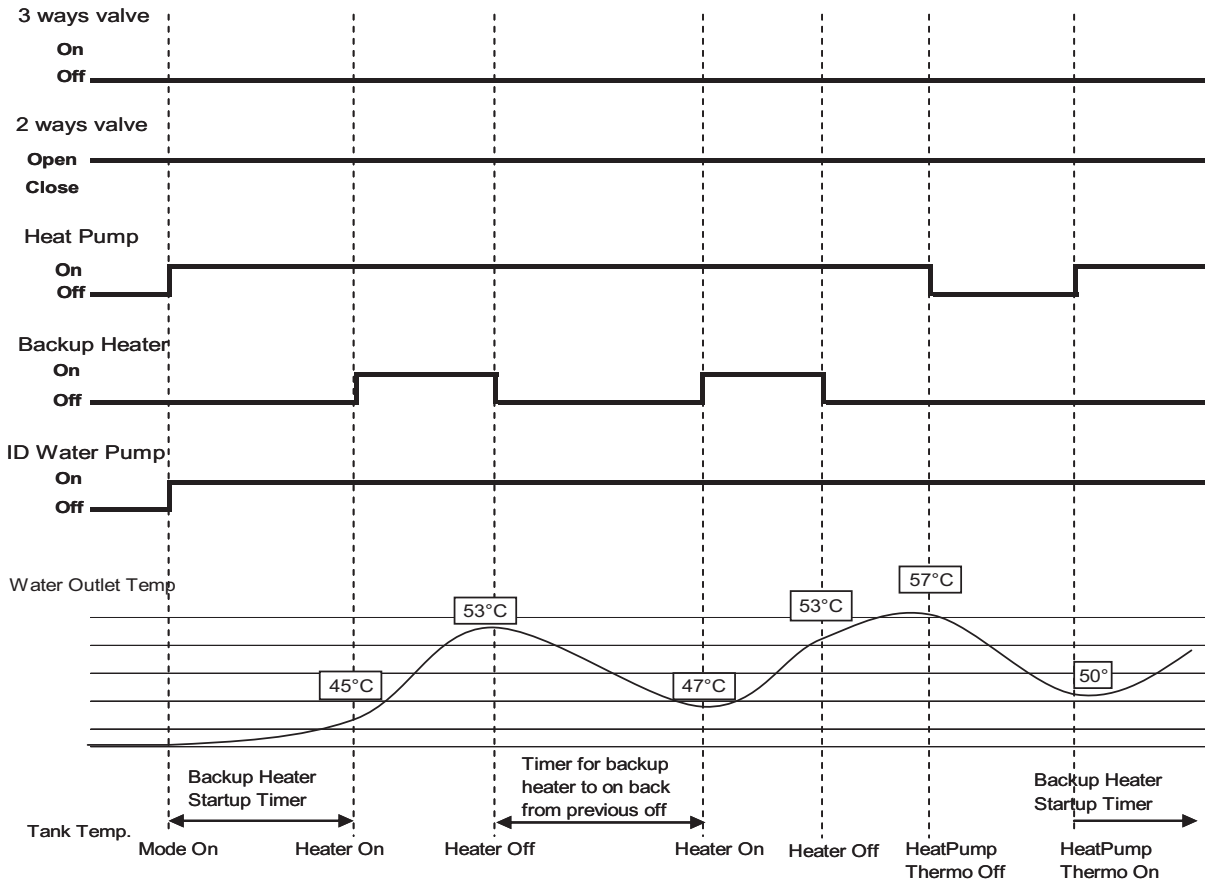

12.1.3 Cooling Operation

12.1.3.1 Thermostat control

- Compressor is OFF when Water Outlet Temperature – Internal Water Setting Temperature > -1.5°C for continuously 3 minutes.
- Compressor is ON after waiting for 3 minutes, if the Water Outlet Temperature – Water Inlet Temperature (temperature at thermostat OFF is triggered) >3°C.

12.1.3.2 Cool Mode Operation

- 1 3 ways valve control:
 - 3 ways valve switch and fix to cooling side.
- 2 Heat pump operates follow normal cooling operation.
- 3 Back up heater DOES NOT operate during cool mode.
- 4 Solar 3 way valve operates follow solar operation specification.
- 5 2 ways valve control:
 - 2 ways valve is closed.

Cool Mode Operation Time Chart

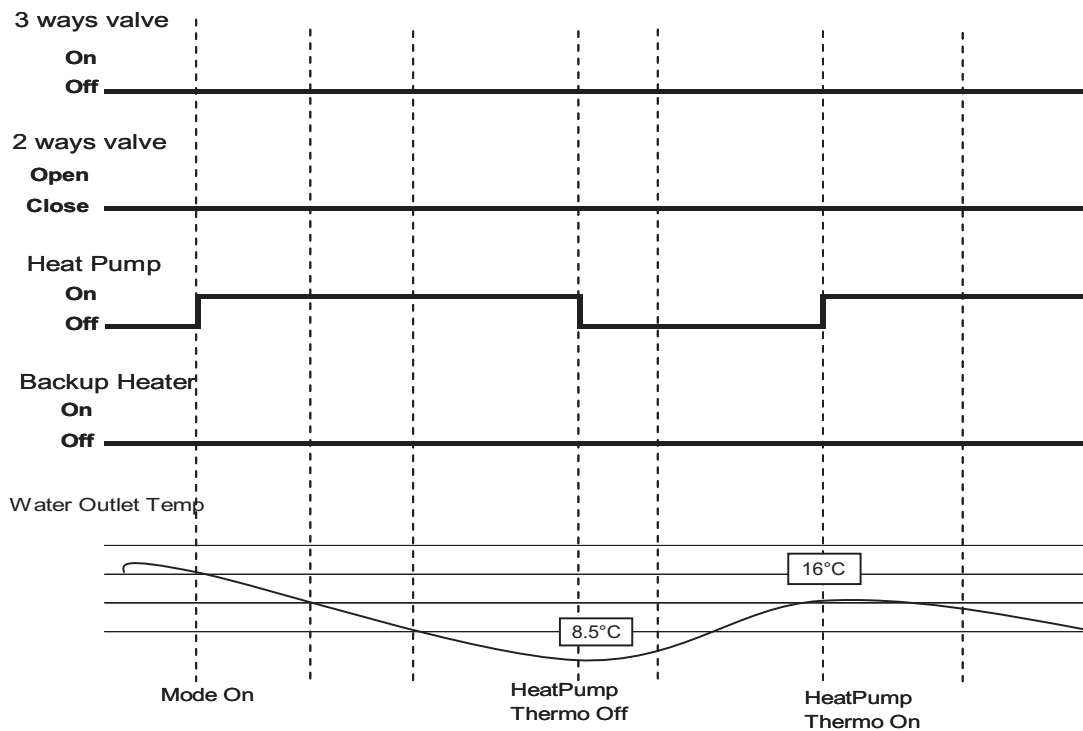

12.1.4 Auto Mode Operation

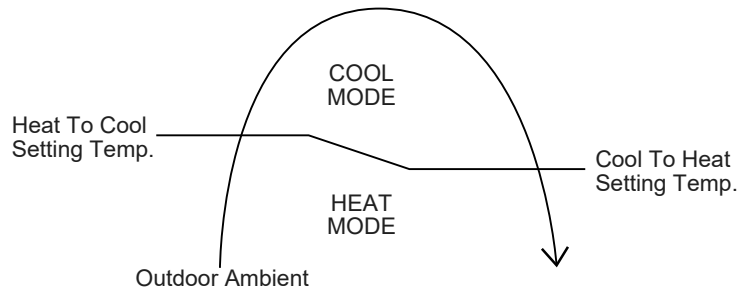

- Control details:
 - To enable the unit to operate either heat or cool mode automatically, heat to cool set temperature and cool to heat set temperature can be set by control panel.
 - Automatic operation is judged based on control panel setting temperature and outdoor ambient temperature.
 - * Minimum setting of heat to cool set temperature is 1°C higher than cool to heat set temperature.
- Judgement control:
 - If outdoor ambient temperature < Heat to Cool Set Temperature, unit will operate in Heat Mode or else the unit will operate in Cool Mode.
 - If current operation is Cool mode, outdoor ambient temperature > Cool to Heat Temperature, unit will maintain Cool mode operation or else the unit will operate Heat mode.
 - If current operation is Heat mode, outdoor ambient temperature > Heat to Cool Temperature, unit will maintain Heat mode operation or else the unit will operate Cool mode.
 - Every 60 minutes the outdoor ambient temperature is judged.
 - When Auto + Tank mode is selected, operation mode switching is judged by both outdoor ambient temperature and indoor air temperature.

12.1.5 Tank Mode Operation

Control contents:

- a. 3 ways valve direction
 - 3 ways valve switch to tank side during TANK THERMO ON condition. Switch 3 ways valve to room side when tank achieve TANK THERMO OFF temperature.
- b. Heat Pump Thermostat characteristic
 - Tank water set temperature = tank set temperature or 51°C whichever lower.
 - Heat pump Water Outlet set temperature is set to 57°C when Outdoor < 5°C and 59°C when Outdoor ≥ 5°C.

Characteristic of heat pump thermo ON/OFF under Tank Mode condition:

- Water Outlet Thermo Condition
 - Heat pump THERMO OFF TEMP:
 1. Water outlet temperature > **Heat Pump Water Outlet Set Temp** for continuously 90 seconds, heat pump OFF but water pump continues ON.
 - Heat pump THERMO ON TEMP:
 1. Heat pump THERMO ON TEMP = Water inlet during thermo OFF time + [-3°C].
 2. When water outlet temperature is less than Heat pump THERMO ON TEMP, heat pump ON.
- Water Inlet Thermo Condition
 - Heat pump THERMO OFF TEMP:
 1. Water inlet temperature is more than 55°C when Outdoor < 5°C and 57°C when Outdoor ≥ 5°C for continuously 30 seconds, heat pump OFF, water pump will continue ON.
 - Heat pump THERMO ON TEMP when Water inlet < water inlet THERMO OFF temperature.

Tank Thermo ON/OFF for HEAT Pump Operation:

- When tank temperature achieve Heat Pump OFF condition, refer below condition:
 - Condition 1 : When Backup Heater for Tank Select USE from remote controller.
 - Heat Pump Turn OFF, Water pump continue ON and Backup Heater will continue boil up the tank if tank temperature below Tank Heater Thermo ON condition. 3 ways valve will only switch to room side after heater boil tank to Tank Heater Thermo OFF condition.
 - Condition 2: When Backup Heater for Tank Select NO USE from remote controller.
 - Heat Pump Turn OFF, water pump turn OFF, Backup heater OFF and 3 ways valve switch to room side.
- When tank temperature achieve Heat Pump ON condition, Water Pump ON, Heat Pump ON and Backup Heater turn OFF
 - Heat Pump OFF Condition at Tank Mode:
 1. Tank Temperature > Tank Water Set Temperature + [0°C] continuously for 10 seconds after heat pump Thermo OFF due to water thermo, (Heat Pump turn OFF but water pump continue ON and Backup Heater Turn ON to boil tank to achieve Tank Set Temperature), **OR**
 2. Tank Temperature > Tank Set TEMPERATURE + [2°C] for continuously 10 seconds (Heat Pump OFF, Water pump OFF, Backup Heater OFF and 3-ways valve switch to room side)
 - Heat Pump ON Condition at Tank Mode:
 1. Tank Temperature < Tank Water Set Temperature + [-8°C]. (Water Pump Turn ON OR Continue ON, Heat Pump ON and 3-ways valve switch to tank side or maintain at tank side)
- c. Backup Heater Control
 - Backup Heater Turn ON condition:
 1. Tank Temperature < Tank Set Temperature + [0°C] **AND**
 2. Heat Pump Thermo OFF **AND**
 3. 20 minutes from previous heater OFF. **AND**
 4. Backup Heater for Tank Select USE from remote controller.

- Backup Heater Turn OFF condition:
 1. Tank Temperature > Tank Set Temperature + [0°C] for continuously 15 seconds. **OR**
 2. Heat Pump Thermo ON **OR**
 3. Mode Change or Operation OFF by remote controller.

* Turn ON All heater element according to the maximum heater selection when heater is request to ON by remote controller.

- d. 2 way valve control:
 - 2 ways valve close.

Tank mode Tank set Temp. = 65°C

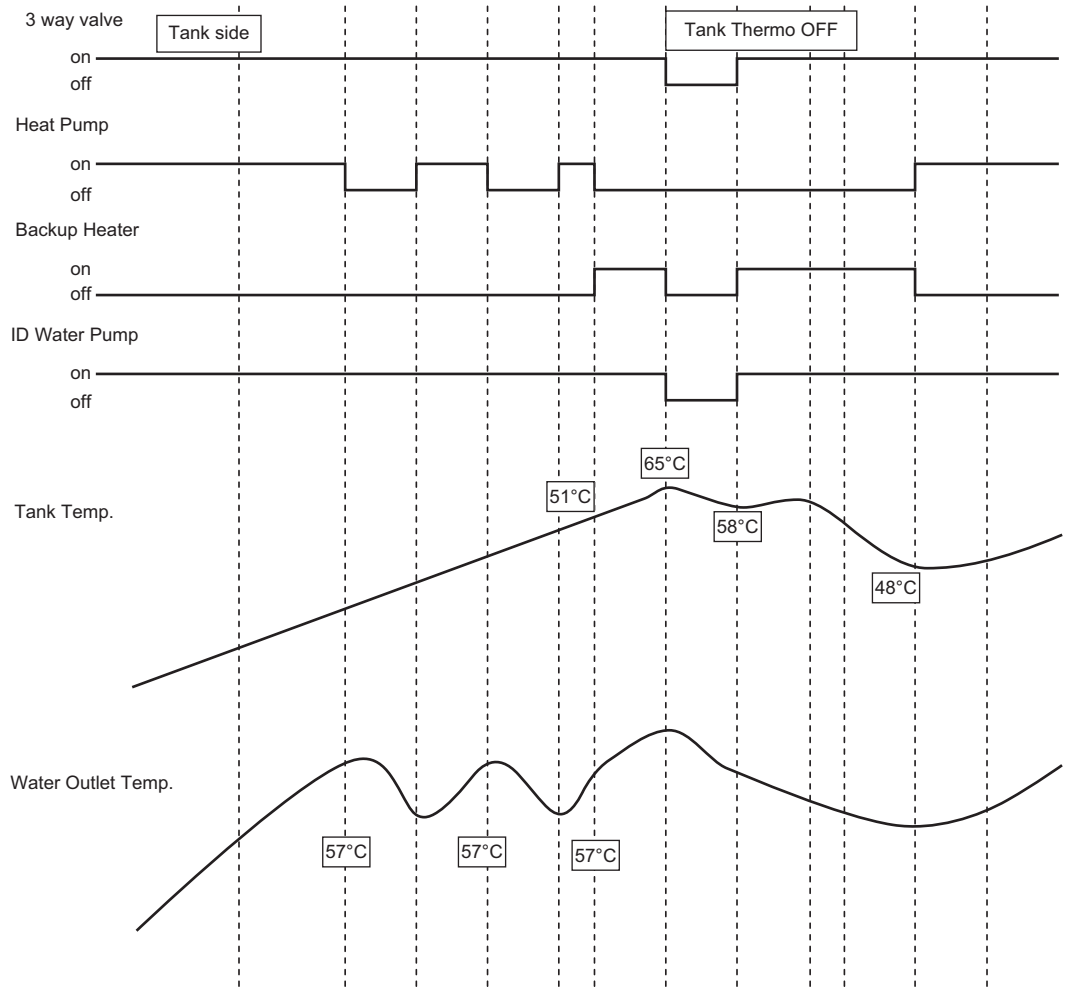

12.1.6 Heat + Tank Mode Operation

1. 3 ways valve control:
 - 3 ways valve switch to room side during room heat-up interval, and switch to tank side during tank heat-up interval. Both modes will switch alternately. Tank mode is the initial running mode of this heat + tank mode (heating no priority).
2. Heat pump operation control:
 - During room heat-up interval
 - Follow normal heating operation.
 - Switch to tank heat-up interval when External Room Thermo OFF **AND** Tank temperature < TANK THERMO ON TEMP (End Room Interval) **OR**
 - During Room heat-up interval, always detect tank temperature and switch to tank heat-up interval when tank temperature < TANK THERMO ON TEMP (End Room Interval)
 - * When heating operation at room side is less than 30 minutes and switch to tank side for consecutive 3 times, heat pump will be forced to operate heat mode at room side and complete the room heat up interval regardless of the tank temperature. After complete the heat interval heat pump will only switch to tank side.
 - During tank heat-up interval
 - Tank Water Set Temperature = tank set temperature or 51°C whichever lower.
 - **Heat Pump Water Outlet set temperature** is set to 57°C when Outdoor < 5°C and 59°C when Outdoor ≥ 5°C.

Characteristic of heat pump thermo ON/OFF under tank side condition:

Water Outlet Thermo Condition

- Heat pump THERMO OFF TEMP:
 1. Water outlet temperature > **Heat Pump Water Outlet Set Temp** for continuously 90 seconds, heat pump OFF but water pump continue ON.
- THERMO ON TEMP:
 1. THERMO ON TEMP = Water inlet when heat pump THERMO OFF + [-3°C].
 2. If water outlet temperature < THERMO ON TEMP **AND** External Room Thermo OFF, heat pump ON.

Water Inlet Thermo Condition

- Heat pump THERMO OFF TEMP
 1. Water inlet temperature is more than 55°C when Outdoor < 5°C and 57°C when Outdoor ≥ 5°C for continuously 30 seconds, heat pump OFF.
- THERMO ON TEMP:
 1. THERMO ON TEMP = Water inlet < water inlet THERMO OFF temperature.

Tank Thermo ON/OFF for Heat Pump Operation:

- When tank temperature achieve Heat Pump OFF condition, refer below condition:
Condition 1: When Backup Heater for Tank Select USE by remote controller
 1. Heat Pump Turn OFF, Water pump continue ON and Backup Heater will continue boil up the tank if tank temperature below Tank Heater Thermo ON condition. End Tank Heat-up Interval and switch 3- ways valve to room side only after heater boil tank to Tank Heater Thermo OFF condition.
Condition 2: When Backup Heater for Tank Select NO USE by remote controller
 1. End Rank Heat-up Interval and switch 3-ways valve to room side, Heat Pump and water pump operate ON/OFF according to room thermo ON/OFF condition.
- When tank temperature achieve Heat Pump ON condition, Water Pump ON and Backup Heater Turn OFF.
Heat Pump OFF Condition at Tank Mode:
 1. Tank temperature > **Tank Water Set Temperature** + [0°C] for continuously 10 seconds after heat pump Thermo OFF due to water thermo, (Heat Pump turn OFF but water pump continue ON and Backup Heater Turn ON to boil and let tank to achieve Tank Set Temperature), **OR**
 2. Tank Temperature > Tank Set Temperature + [2°C] for continuously 10 seconds.
(End Tank interval and switch 3-ways vale to room side and start heat interval)
Heat Pump ON Condition at Tank Mode:
 1. Tank Temperature < Tank Water Set Temperature + [-8°C].
(Water Pump ON, Heat Pump ON and Backup Heater OFF)

3. Backup Heater Control:
- During heating heat up interval
 - Follow normal back up heater control operation
 - During tank heat-up interval

Backup Heater Turn ON condition:

 - Tank Temp. < Tank Set Temp + [0°C] **AND**
 - Heat Pump Thermo OFF **AND**
 - 20 minutes from previous heater OFF. **AND**
 - Backup Heater for Tank Select USE by remote controller.

Back up Heater Turn OFF condition:

- Tank Temperature > Tank Set Temperature + [0°C] for continuously 15 seconds **OR**
 - Heat Pump Thermo ON **OR**
 - Mode Change or Operation OFF by remote controller
- * Turn ON all heater element according to the maximum heater selection when heater is request to ON by remote controller.

4. 2-way valve control:
- 2-ways valve opens.

Heat + Tank mode Tank set Temp. = 60°C

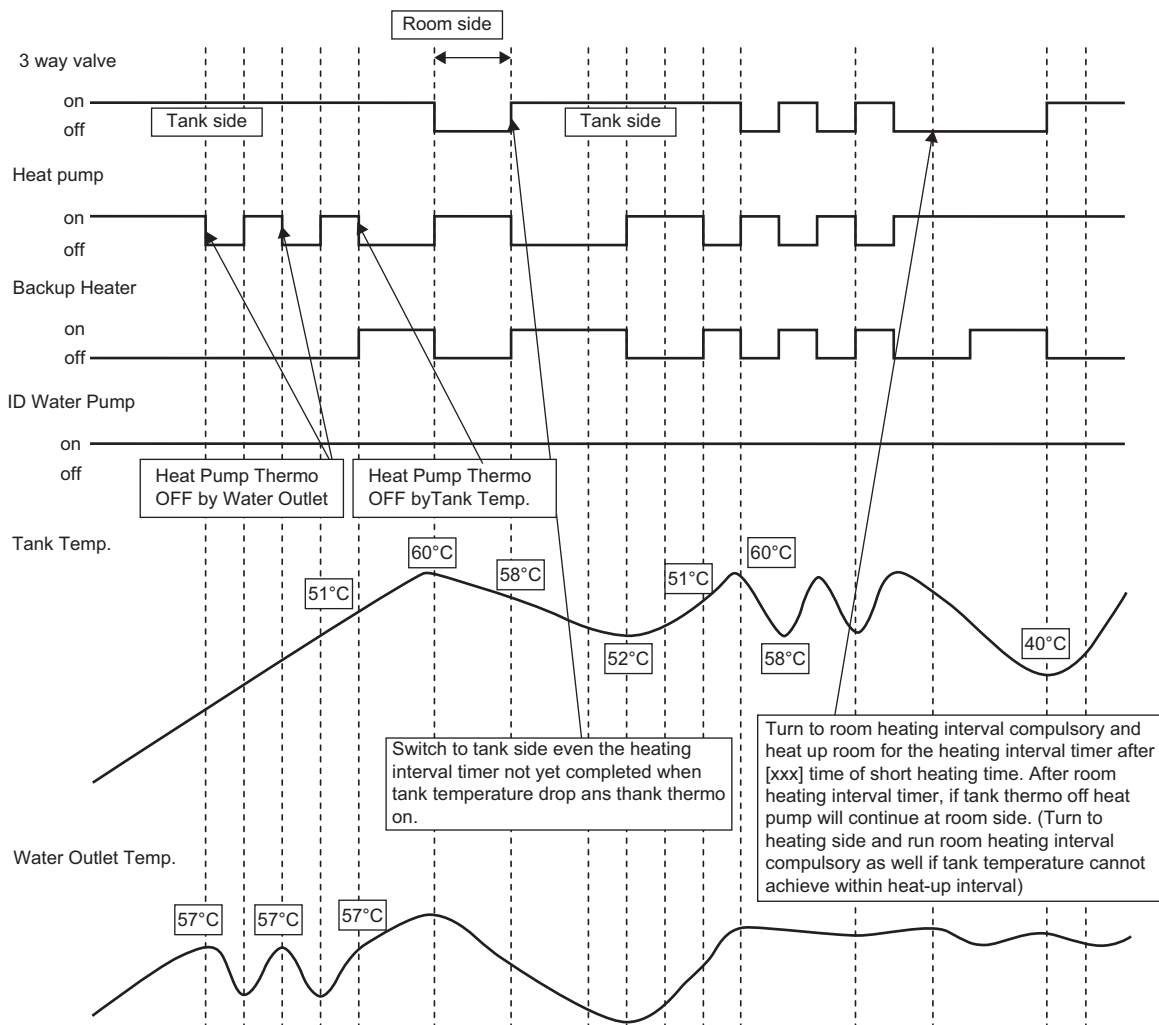

12.1.7 Cool + Tank Mode Operation

1. 3 ways valve control:
 - 3-ways valve switch to room side during room cooling interval and switch to tank side during tank heat-up interval. Both mode switch alternately. Tank mode is the initial running mode of this cool + tank mode.
2. Heat pump operation control:-
 - a) During room cooling operation
 - Follow normal cooling operation.
 - Switch to tank heat-up interval when External Room Thermo OFF **AND** Tank Temperature < TANK THERMO ON TEMP (End Room Interval) **OR**
 - During Room heat-up interval, always detect tank temperature and switch to tank heat-up interval when tank temperature < TANK THERMO ON TEMP (End Room Interval)
 - * When heating operation at room side is less than 30 minutes and switch to tanks side for 3 consecutive times, heat pump will be forced to operate heat mode at room side and complete the room heat up interval regardless of the tank temperature. Heat pump operation will only switch to tank side after complete the heat interval.
 - b) During tank heat-up interval
 - Tank water set temperature = tank set temperature or 51°C whichever lower.
 - **Heat Pump Water Outlet set temperature** is set to 57°C when Outdoor < 5°C and 59°C when Outdoor ≥ 5°C.

Characteristic of heat pump thermo ON/OFF under tank side condition:

a) Water Outlet Thermo Condition

- Heat pump THERMO OFF TEMP:
 1. Water outlet temperature > **Heat Pump Water Outlet Set Temp** for continuously 90 seconds, heat pump OFF but water pump continue ON.
- THERMO ON TEMP:
 1. THERMO ON TEMP = Water inlet when heat pump thermo OFF + [-3°C].

b) Water Inlet Thermo Condition

- Heat pump THERMO OFF TEMP:
 1. Water inlet temperature is more than 55°C when Outdoor < 5°C and 57°C when Outdoor ≥ 5°C for continuously 30 seconds, heat pump OFF.
- THERMO ON TEMP = Water inlet < water inlet THERMO OFF temperature.

Tank Thermo ON/OFF for Heat Pump Operation:

- When tank temperature achieve Heat Pump OFF condition, refer below condition:

Condition 1: When remote controller Select USE for Backup Heater for Tank.

 1. Heat Pump Turn OFF, Water pump continue ON and Backup Heater will continue to ON if tank temperature below Tank Heater Thermo ON condition. Tank heat-up Interval ends and 3 ways valve is switch to room side after Tank temperature achieve Tank Heater Thermo OFF condition.

Condition 2: When remote controller Select NO USE for Backup Heater for Tank.

2. Tank Heat-up Interval ends and 3-ways valve is switch to room side, Heat Pump and water pump operate ON/OFF according to room thermo ON/OFF condition.

When tank temperature achieve Heat Pump ON condition, Water Pump ON, Heat Pump ON and Backup Heater Turn OFF.

Heat Pump OFF Condition at Tank Mode:

1. Tank Temperature > **Tank Water Set Temperature** + [0°C] for continuously 10 seconds after heat pump Thermo OFF due to water thermo, (Heat Pump turn OFF but water pump continue ON and Backup Heater keep Turn ON until tank achieve Tank Set Temperature), **OR**
2. Tank Temperature > Tank Set Temperature + [2°C] for continuously 10 seconds (Tank Interval ends and 3-ways valve is switch to room side and Cool Interval starts).

Heat Pump ON Condition at Tank Mode:

1. Tank Temperature < Tank Water Set Temperature + [-8°C] (Water Pump ON, Heat Pump ON and Backup Heater Turn OFF)

3. Backup Heater Control:
 - During Cooling interval
 - Backup Heater will not operate during Cool Mode.
 - During tank heat-up interval
 - Backup Heater Turn ON condition:
 - Tank Temperature < Tank Set Temperature + [0°C] AND
 - Heat Pump Thermo OFF AND
 - 20 minutes from previous heater OFF. AND
 - Remote controller Select USE for Backup Heater for Tank.
 - Backup Heater Turn OFF condition:
 - Tank Temperature > Tank Set Temperature + [0°C] for continuously 15 seconds OR
 - Heat Pump Thermo ON OR
 - Mode Change or Operation OFF by remote controller

* Turn ON all heater element according to the maximum heater selection when heater is request to ON by remote controller.
4. 2-way vale control:
 - 2-ways valve opens.

Cool + Tank mode

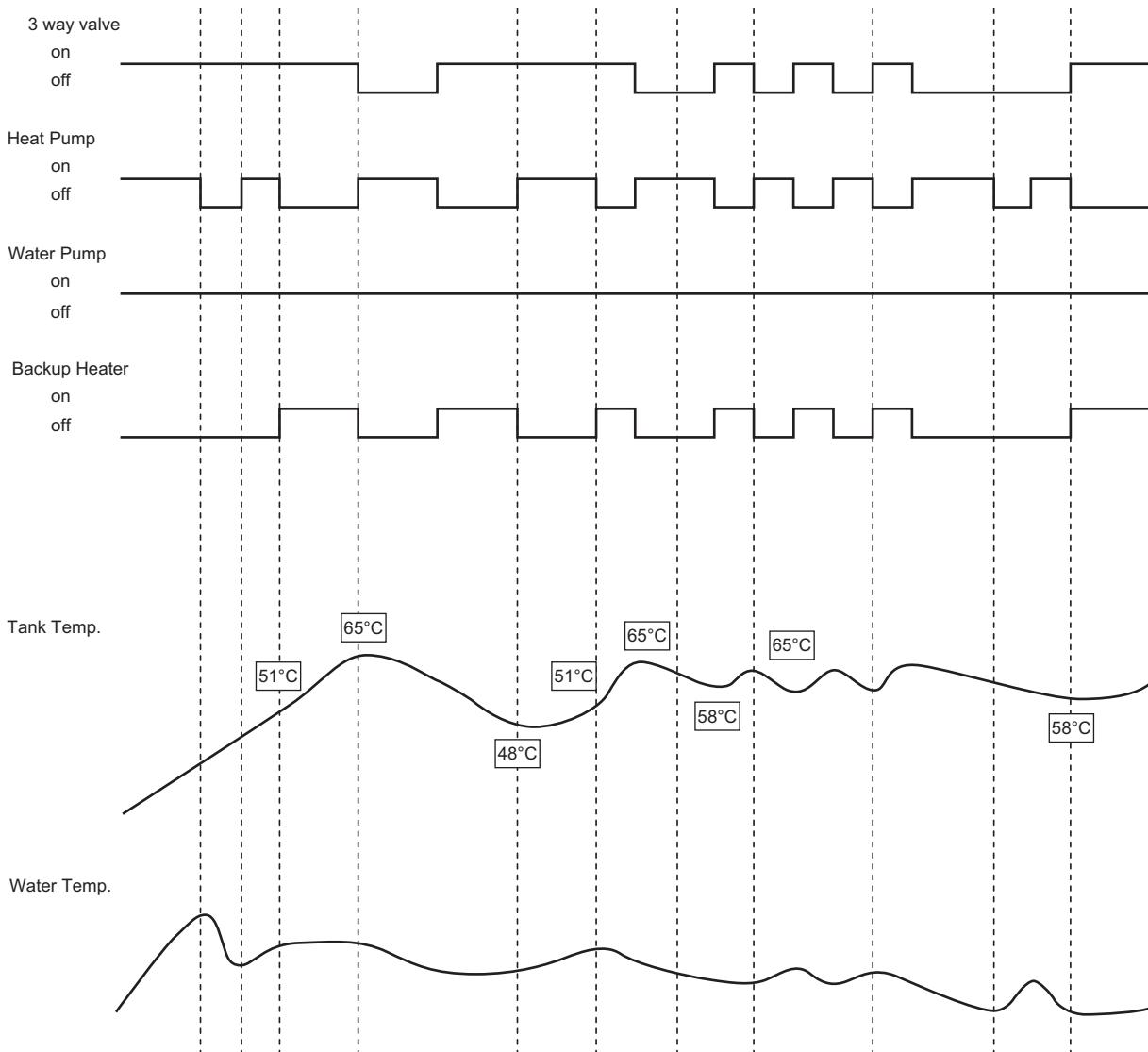

12.1.8 Setting Water Outlet Temperature for Heat Mode

- The set temperature defines the parameters for the outdoor ambient temperature dependent operation of the unit. Where by the internal water setting temperature is determined automatically depending on the outdoor temperature. The colder outdoor temperatures will result in warmer water and vice versa. The user has the possibility to shift up or down the target water temperature by control panel setting.

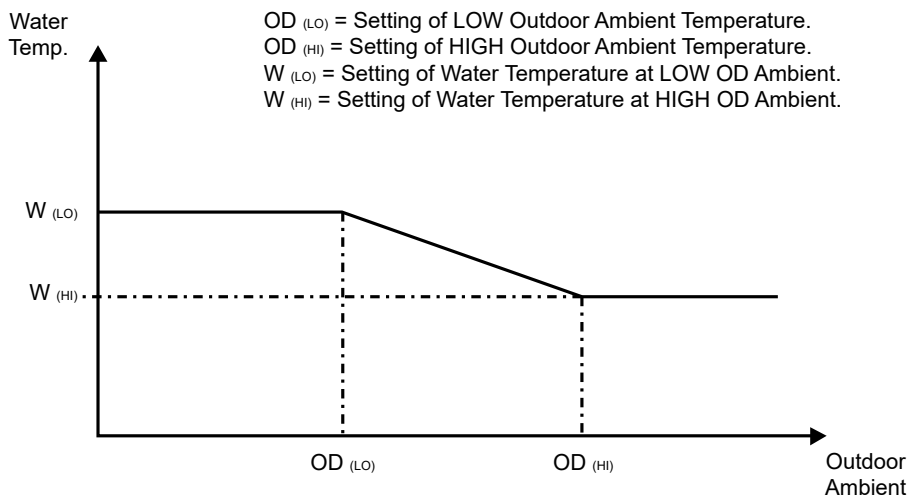

- Outdoor temperature is updated every 30 minutes when operation ON.
- Setting water outlet temperature always follow $W_{(Lo)}$ or $W_{(Hi)}$ whenever is higher if outdoor ambient sensor or indoor communication error happen.

Operation under tank mode

- When heat pump operates to tank side, the water outlet target temperature is 55°C.

12.1.9 Water Temperature Thermo Shift Setting

- Switches are ignored during "PUMPDW" = ON.
 - Switches are ignored during "STATUS" = ON.
 - "▲", "▼", "SELECT" switch are ignored if "SETTING" = OFF.
 - "CANCEL" switch is ignored if "SETTING" = OFF & "STATUS" = OFF.
 - If "SET" Switch pressed for less than 5secs, immediately enter water temperature shift setting mode.
 - Once enter this setting mode, "SETTING" display is ON.
- This setting mode is used to easily shift the target water outlet temperature.

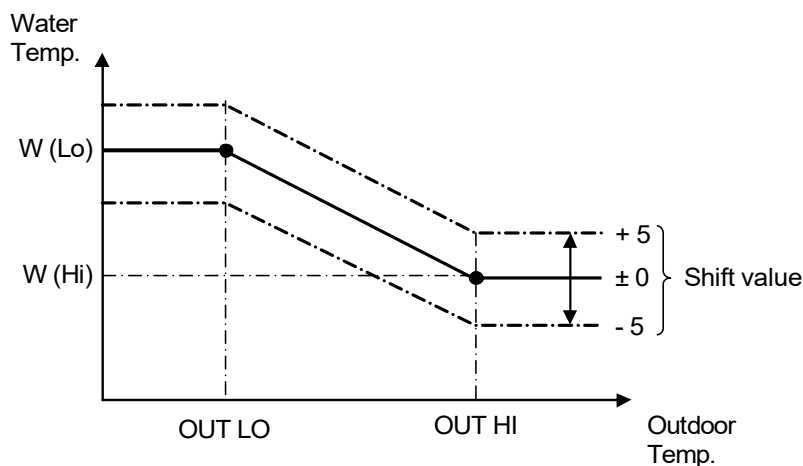

- OUT LO = Low outdoor ambient set temperature
- OUT HI = High outdoor ambient set temperature
- $W_{(Lo)}$ = Water outlet set temperature at low outdoor ambient set temperature
- $W_{(Hi)}$ = Water outlet set temperature at high outdoor ambient set temperature
- Shift value = Setting water temperature thermo shift

12.1.10 Outdoor Fan Motor Operation

Outdoor fan motor is adjusted according to operation condition. It starts when compressor starts operation and it stops 30 seconds after compressor stops operation.

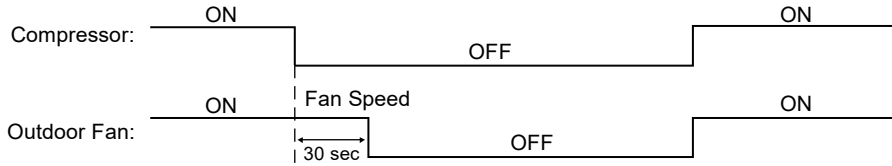

12.2 Water Pump

12.2.1 Water Pump Control

- Once the indoor unit is ON, the water pump will be ON immediately and no error judgement for 9 minutes. However, during this 9 minutes operation, if there is any abnormality cause at outdoor or malfunction, the compressor should be OFF immediately and restart delay after 3 minutes.
- The system will start checking on the water flow level after operation start for 9 minutes. If water flow level is detected low continuously 10 seconds, the water pump and the compressor will be OFF permanently and OFF/ON control panel LED will blink (H62 error occurs).
- When error happens, the power has to be reset to clear the error.
- If there is no error indication, the water pump shall be continuously running.
- The water pump will remain ON when compressor OFF due to thermostat OFF setting is reached.
- Water pump must always operate during heating mode, deice operation and also during heater ON condition.
- Water pump will stops 15 seconds after the unit stops operation.

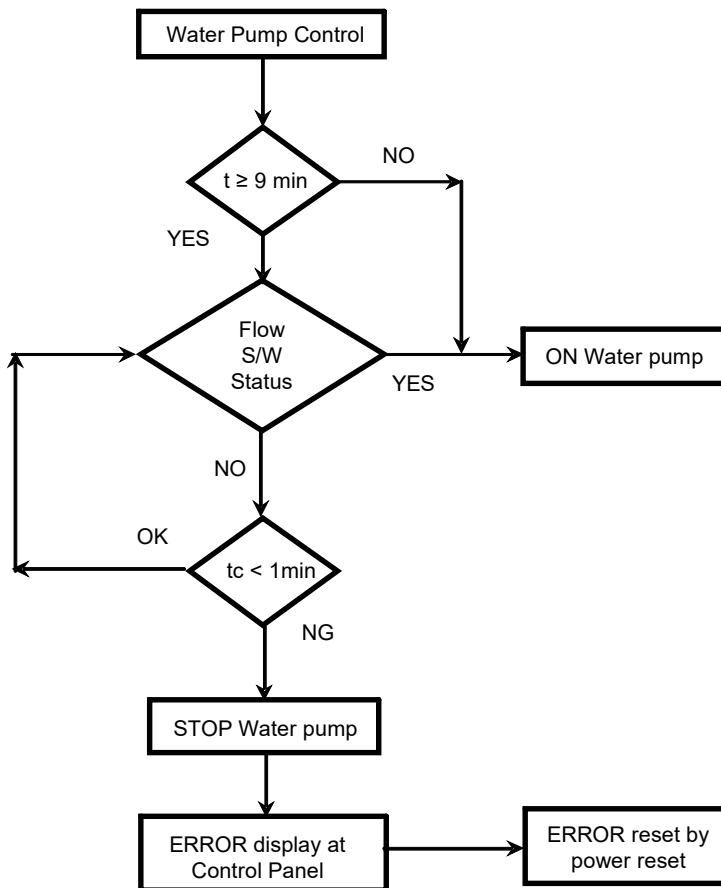

12.2.2 A-class Pump Specification

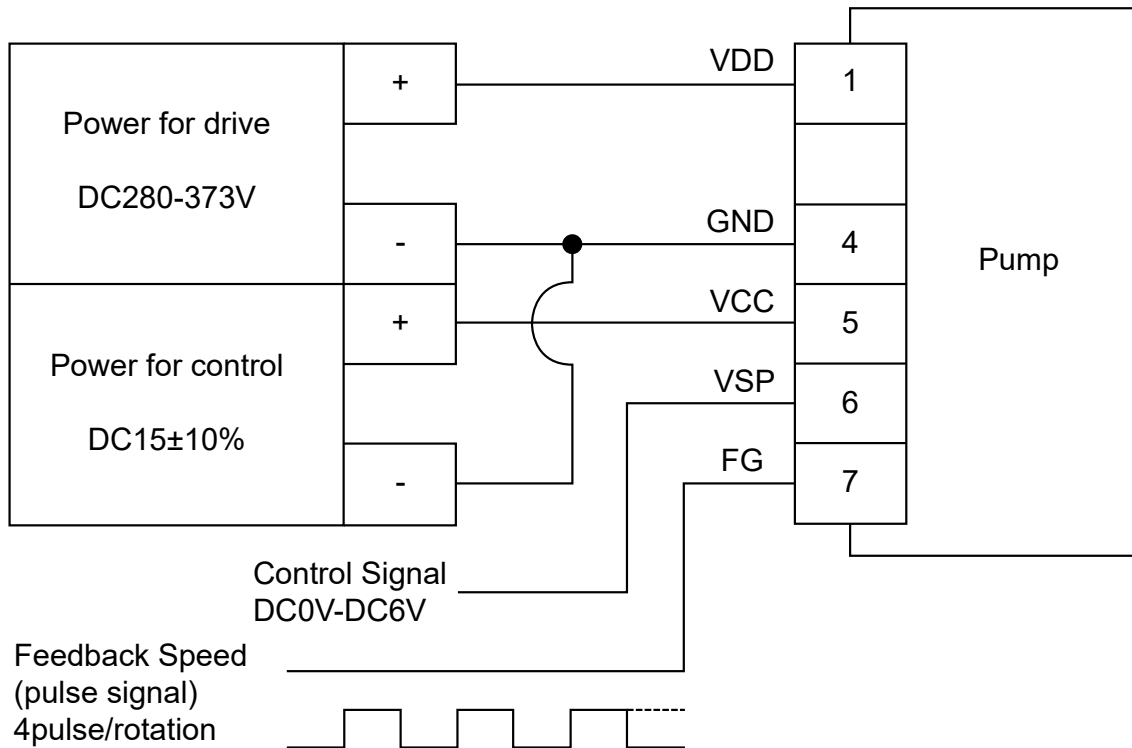

Control signal is analog voltage (DC0V-6V) generated by microcomputer PWM port. Microcomputer can change analog voltage by changing PWM duty.

12.2.3 Water Flow Rate Setting

- Set water pump speed to adjust the water flow rate.

Depend on the hydraulic system pressure loss and type, the water flow rate can be adjusted by control panel.

- 1 Press SERVICE button for 5 seconds.
- 2 Press ▲ button to enter menu S02 and press SET button.
- 3 Press SELECT button then press ▲/▼ button to change SPEED and press SET to confirm.
- 4 Press OFF/ON button to quit setting.

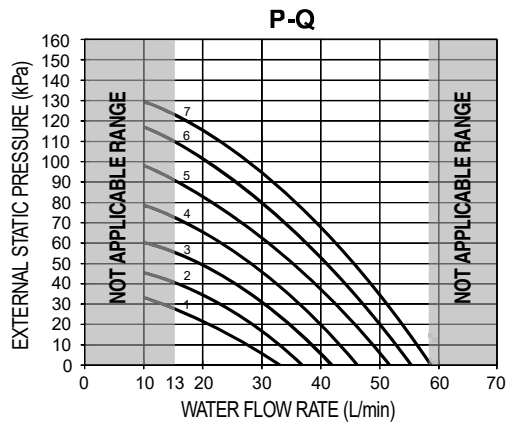

Note:

- * Before adjust the water flow rate, make sure the total water volume in the installation is minimum 30 litres for heating side.
- * Please ensure the minimum flow rate is not less than 8l/min and not more than 50l/min.

12.2.4 Water Pump Speed Feedback Error

- Basically pump speed feedback is control by micon.
- When pump speed is below low limit or over high limit for a few seconds, micon detect pump error and system is stopped.
- Error detection conditions:
 - Current pump speed < 1000 rpm or
 - Current pump speed > 6000rpm for 10 seconds.
- Control contents:
 - When error occurs, water pump, heating and heater is stopped for 30 seconds then restart again (Retry control).
 - When micon detect error again, system is stopped and error code [H20] is displayed at control panel.

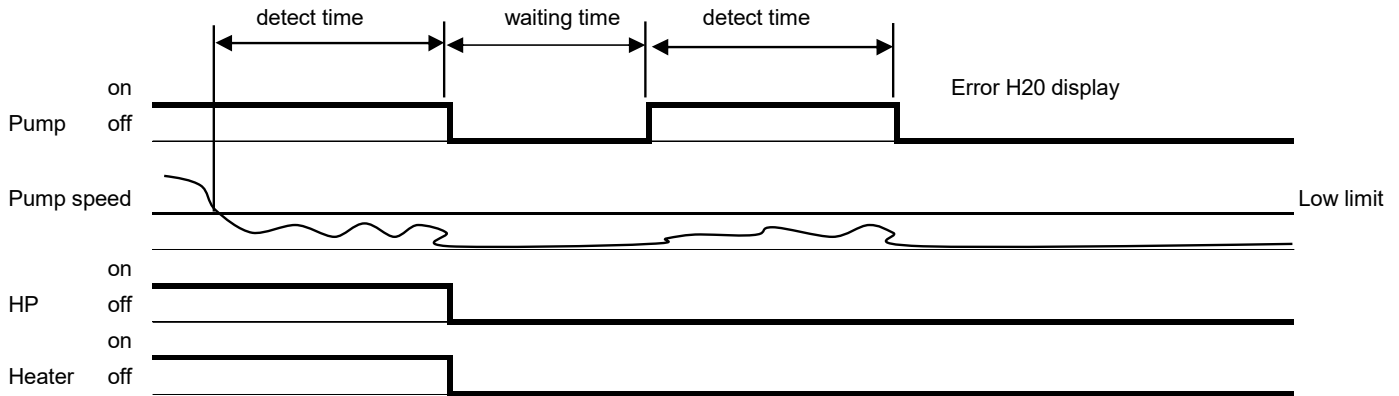

12.2.5 Water Pump Only Operation

Purpose

Circulate and fill the piping with water during installation time

- Water pump only circulation can be set from the control panel SERVICE S/W when the operation is in Standby Mode.
- Press the SERVICE S/W for continuous 5 sec to enter Service Mode.
- In Service Mode, select SR: 02 and press SET S/W to start water pump only operation.
- 3 way valve turn OFF and 2 way valve turn ON.
- Water pump will stop operation when H62 is triggered.
- Press the OFF/ON button to stop the water pump only operation.

12.3 Pump Down Operation [Service Mode: 01]

Purpose

Ensure the pump down operation when relocating or disposing of the unit. The pump down operation will extract all refrigerant from the piping into the outdoor unit.

Controls:

- 1 Press the SERVICE S/W for continuous 5 seconds to enter Service Mode.
- 2 In service mode, select Sr: 01 and press SET S/W to start Pump Down operation.
- 3 There will be no low pressure error and freeze prevention judgement during Pump Down operation.
- 4 3 ways valve will shift to room side and 2 ways valve will turn ON.
- 5 Press OFF/ON button to stop the unit.

12.4 Flow Switch

12.4.1 Flow Switch Control

- 1 The water flow switch serves as an overload protector that shuts down the unit when the water level is detected to be low.
- 2 Detection is Lo (0 V) when there is no water flow, and detection is Hi (5 V) when there is water flow.

12.5 Indoor Unit Safety

12.5.1 Indoor Unit Safety Control

- 1 When water pump is ON, the system will start checking flow switch status (ON/OFF).
- 2 If the flow switch ON for 10 seconds, the system will check on the water inlet temperature for 10 seconds. If the water inlet temperature not exceeds 80°C, the water pump shall be continuously running with normal mode.
If the water inlet temperature exceeds 80°C for continuously 10 seconds, the water pump will be OFF immediately.
- 3 After water pump OFF for more than 10 minutes, it will be ON back and the indoor unit safety control checking is restarted.

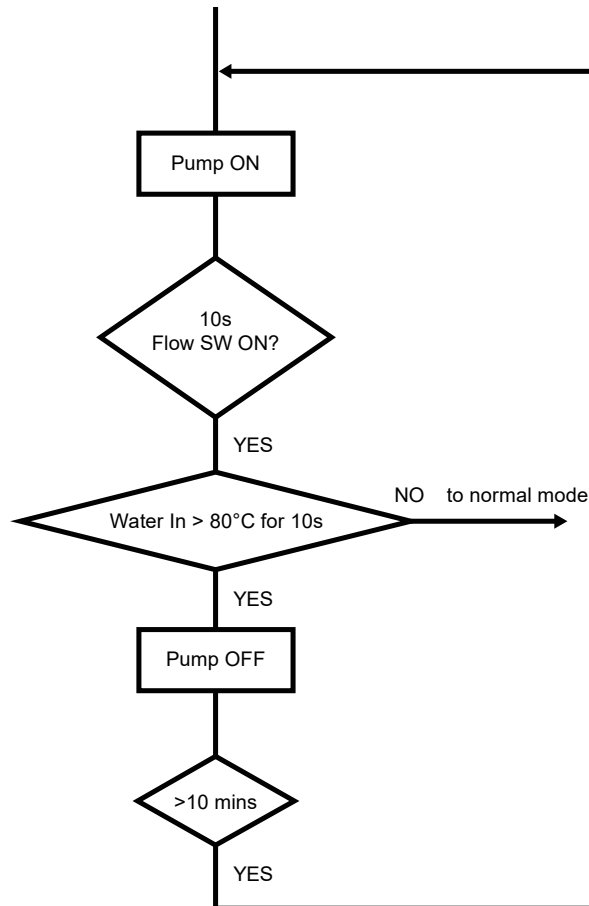

12.6 Auto Restart Control

- 1 When the power supply is cut off during the operation of Air-to Water Hydromodule + Tank, the compressor will re-operate after power supply resumes.

12.7 Indication Panel

LED	Operation
Color	Green
Light ON	Operation ON
Light OFF	Operation OFF

Note:

- If Operation LED is blinking, there is an abnormality operation occurs.

12.8 Indoor Back-Up Heater Control

12.8.1 Indoor Electric Heater Control

- 1 Normal Heating Mode
 - Heater On condition:
 - a. Heater switch is ON
 - b. After Heatpump thermo ON for **[30]** mins
 - c. After water pump operate **[9]** mins
 - d. Outdoor air temperature < Outdoor set temperature for heater
 - e. When water outlet temperature < Water set temperature + **[-8°C]**
 - f. **[20]** minutes since previous Backup heater Off
 - * When heatpump cannot operate due to error happens during normal operation, heater will go into force mode automatic
 - * Heater need to operate during deice operation
 - Heater Stop Condition:
 - a. When outdoor set temperature > outdoor set temperature + **[+2°C]** for continuous 15 secs OR
 - b. When water out temp > water set temperature + **[-2°C]** for continuous 15 secs OR
 - c. Heater switch is Off OR
 - d. Heatpump thermo-off or OFF condition
- 2 Force Heater Mode
 - Heater On condition:
 - a. After water pump operate **[9]** mins
 - b. When water outlet temperature < water set temperature + **[-8°C]**
 - c. **[20]** minutes since previous Backup heater Off
 - Heater Stop condition
 - a. Force mode off **OR**
 - b. When water outlet temperature > water set temperature + **[-2°C]** for continuous 15 secs

* Do not operate heater at the following situation

- 1 Water outlet temperature sensor, and water inlet sensor abnormal
- 2 Flow switch abnormal
- 3 Circulation pump stop condition
- 4 During Heatpump switch to tank side

12.9 Heater Control for Tank Side

- Backup heater turn ON at tank side after fulfill below condition:
 - 1 Tank Temperature < Tank Set Temperature + [0°C] **AND**
 - 2 Heat Pump Thermo OFF. **AND**
 - 3 20 minutes from previous heater OFF. **AND**
 - 4 Remote controller Select USE for Backup Heater for Tank.

- Backup Heater Turn OFF condition:
 - 1 Tank Temperature > Tank Set Temperature + [0°C] for continuously 15 seconds. **OR**
 - 2 Heat Pump Thermo ON. **OR**
 - 3 Mode Change or Operation OFF by remote controller.

* Backup Heater Turn ON/OFF all together according to the selected heater capacity.

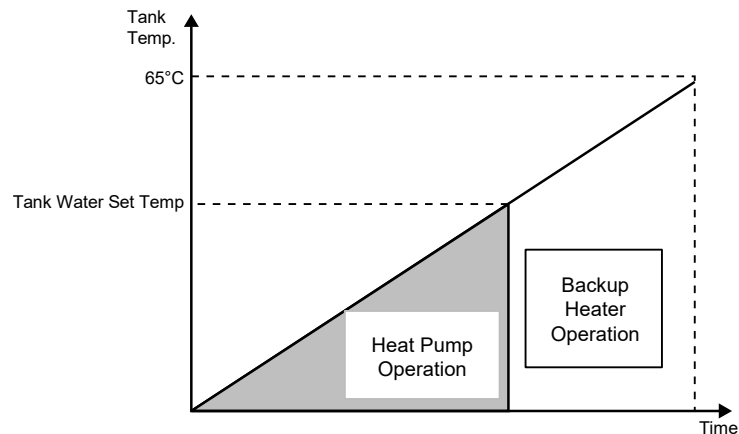

12.10 Base Pan Heater Control (Optional)

- To enable the base pan heater function, control panel initial setting has to be manually adjusted by activating Base Pan Heater menu.
- There are 2 optional start condition can be selected, Type A or Type B.
- Control details:

1 Type A: (Default Auto Mode)

Start conditions:

- When outdoor air temperature $\leq 3^{\circ}\text{C}$ during heating and deice operation is ON.

Control contents:

- Base pan heater is ON during deice operation and continues ON for 10 minutes after deice operation ends.

Cancel condition:

- When outdoor temperature $> 6^{\circ}\text{C}$ after deice end or
- When operation is not at heating mode or
- Base pan heater ON timer count is completed.

2 Type B: (ON Mode)

Start conditions:

- When outdoor air temperature is $\leq 5^{\circ}\text{C}$ and operates in heating mode, base pan heater is ON.

Cancel conditions:

- When outdoor air temperature is $> 7^{\circ}\text{C}$ or
- When operation is not at heating mode.

Note:

* Base pan heater cannot be ON during test mode and standby mode.

12.11 Tank Pre-thermo OFF control

- Purpose:
 - To achieve higher tank temperature by heat pump before thermo off.
- Control content:
 - Indoor activate tank pre-thermo control and send ON bit to outdoor after fulfilled all the control starting condition.
 - Starting condition:
 - This control activates after fulfilled all below conditions for continuously 10 seconds.
 - Tank operation AND
 - Outdoor ambient $\geq 10^{\circ}\text{C}$ AND
 - Water inlet temperature $\geq 50^{\circ}\text{C}$ OR water outlet temperature $\geq 56^{\circ}\text{C}$
 - End condition:
 - This control will be disabled when,
 - Tank operation OFF OR
 - Outdoor ambient $< 10^{\circ}\text{C}$ OR
 - Tank thermo OFF OR
 - Water inlet OFF temperature OR
 - Water temperature thermo OFF OR
 - Water inlet temperature $< 50^{\circ}\text{C}$ AND Water outlet temperature $< 56^{\circ}\text{C}$

* Compressor frequency and fan speed will be controlled.

12.12 Sterilization Mode

- Purpose:
 - Increase tank temperature to boiling set temperature to operate sterilization.
- Sterilization control can only be star when:
 - Tank Connection Select “YES”
 - Backup heater for tank side Select “YES” or “NO”
 - Sterilization function select “YES”

(Sterilization temperature, timer starts and continues time can be set by remote controller)

- Control details:
 - Sterilization Control Start Condition:
 - When sterilization timer is reach, remote control will send the sterilization ON to indoor.
 - Sterilization will start if current operation is ON (With any mode)
 - Indoor will memorize the running mode when sterilization is start (start sterilization timer) and switch to tank side.
 - Tank mode running internally but no feedback to remote control. Remote control will remain display the previous mode.
 - Operate as tank mode which heat pump will operate till heat pump thermo OFF and backup heater will ON after heat pump thermo OFF to achieve tank sterilization set temperature.
 - Sterilization Control End Condition:
 - After achieve tank sterilization temperature, unit will start to count the continue time and remain as tank sterilization mode operation. After continue timer reach remote control set continue time, sterilization function will end and resume back to previous memorized mode. OR
 - After sterilization function start for maximum 4 hours but still not achieve the sterilization temperature or not fulfill the continue time. Sterilization function ends and resume back to previous memorized running mode. OR
 - Power reset OR
 - Timer ON/OFF signal, or Mode Change or Operation OFF is request. OR
 - Holiday timer End and start heat pump operation.

12.13 Heating Outdoor Ambient Thermo OFF Control

- Purpose:
 - To stop provide heating to room side during high outdoor ambient condition

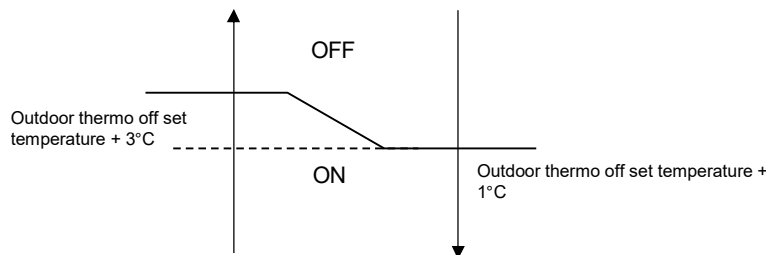

- Control content:
 - Heating outdoor ambient thermo off control only effective when heat pump operates in heat mode to room side. (This control will not activate when running in tank side)
 - Heat pump and water pump will turn OFF when outdoor ambient is higher than outdoor thermo off set temperature.
 - Heat pump will ON back when outdoor ambient temperature < Outdoor thermo off set temperature + [1°C].

12.14 Quiet Operation

- Purpose:
 - To provide quiet operation compare to normal operation by reduces outdoor unit noise.
- Starting condition:
 - When quiet button is presses.
 - When quiet is request to ON by weekly timer. (Refer to control panel)
- When any of above mentioned condition is achieved, this control is activated.
New target FM speed = Present target FM speed – 80 rpm
Minimum target FM speed = 200 rpm
- Cancellation condition:
 - Cancel by pressing quiet button.
 - Stop by OFF/ON button
 - When quiet is request to OFF by weekly timer.

12.15 Anti Freeze Control

- Anti freeze protection control menu can be set YES or NO by control panel.
- In heatpump system, there are 3 types of anti freeze control:
 1. Expansion tank anti-freeze control
 - Expansion tank anti freeze heater ON condition:
 - Outdoor ambient temp. < 3°C
 - Expansion tank anti freeze heater OFF condition:
 - Outdoor ambient temp. > 4°C
 2. Water pump circulation anti freeze control
 - Water pump turns ON when **ALL** below conditions are fulfilled:
 - Heatpump OFF (stand by) OR error occurs.
 - Water flowing flag is ON.
 - Water flow switch is not abnormal.
 - Outdoor ambient temp. < 3°C OR outdoor ambient temp. sensor is abnormal.
 - Water inlet/outlet temp. < 6°C.
 - After 5 minutes from previous water pump OFF.

- Water pump turn OFF when **ANY** of below conditions is fulfilled:
 - Outdoor ambient temperature $\geq 4^{\circ}\text{C}$.
 - During $-5^{\circ}\text{C} < \text{outdoor ambient temp.} < 4^{\circ}\text{C}$
 - After water pump ON for 4 minutes, and water inlet temp. $\geq 8^{\circ}\text{C}$.
 - Else, shift to back up heater anti freeze control.
 - During outdoor ambient temp. $< -5^{\circ}\text{C}$
 - After water pump ON for 4 minutes, and water inlet/outlet $\geq 20^{\circ}\text{C}$.
 - Else, shift to back up heater anti freeze control.
- However, if flow switch is abnormal (H62), then water pump circulation anti freeze control will not activate.

3. Back up heater anti freeze control:

- Back up heater turn ON when **ALL** below conditions is fulfilled:
 - Water inlet/outlet temp. $< 6^{\circ}\text{C}$.
 - Water pump circulation anti freeze control activated and water pump ON for 4 minutes.
- Back up heater turns OFF when ANY of below conditions is fulfilled:
 - Water inlet/outlet temp. $> 28^{\circ}\text{C}$.
 - Water pump circulation anti freeze control deactivated/water pump OFF.
- However, if back up heater is abnormal (H70) then back up heater anti freeze control will not activate.

12.16 External Room Thermostat Control (Optional)

Purpose:

- 1 Better room temperature control to fulfill different temperature request by external room thermostat.
Recommended external room thermostat:

Maker	Characteristic
Siemen (REV200)	Touch panel
Siemen (RAA20)	Analog

Connection of external room thermostat:

Wire Connection and thermo characteristic of Siemen REV200:

Setting	L/L1 (H)	Heat Thermo	L/L2 (C)	Cool Thermo
Set Temp < Actual Temp	Open Circuit	OFF	Short Circuit	ON
Set Temp > Actual Temp	Short Circuit	ON	Open Circuit	OFF

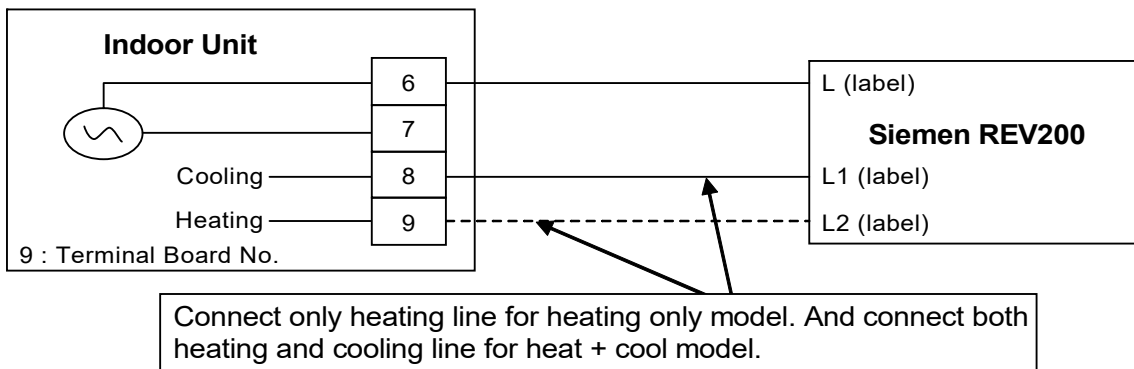

Wire Connection and thermo characteristic of Siemen RAA20:

Setting	L/Y1 (H)	Heat Thermo	L/Y2 (C)	Cool Thermo
Set Temp < Actual Temp	Open Circuit	OFF	Short Circuit	ON
Set Temp > Actual Temp	Short Circuit	ON	Open Circuit	OFF

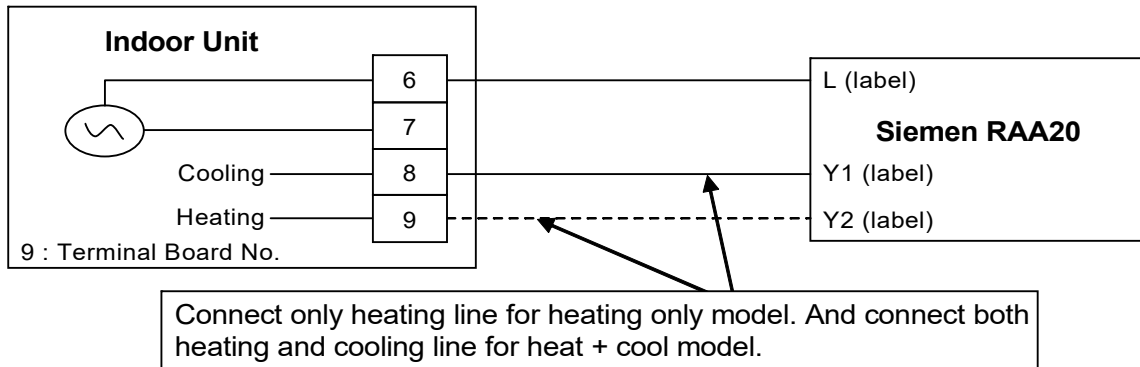

Control Content:

- External room thermostat control activate only when remote thermostat connection select YES by Indoor control panel.
- When indoor running heat mode, refer thermo On/Off from heating line feedback. And when indoor running cool mode, refer thermo On/Off from cooling line feedback.
- Heat pump Off immediately when receive thermo off feedback.

12.17 Three Ways Valve Control

Purpose:

- 3 ways valve is used to change flow direction of hot water from heat pump between heating side and tank side.

Control contents:

- 1 3 ways valve switch Off:
 - o During 3 ways valve switch Off time, the hot water will provide heat capacity to heating side.
- 2 3 ways valve switch On:
 - o During 3 ways valve switch On time, the hot water will provide heat capacity to tank side.
- 3 Stop condition:
 - o During stop mode, 3 ways valve will be in switch off position.

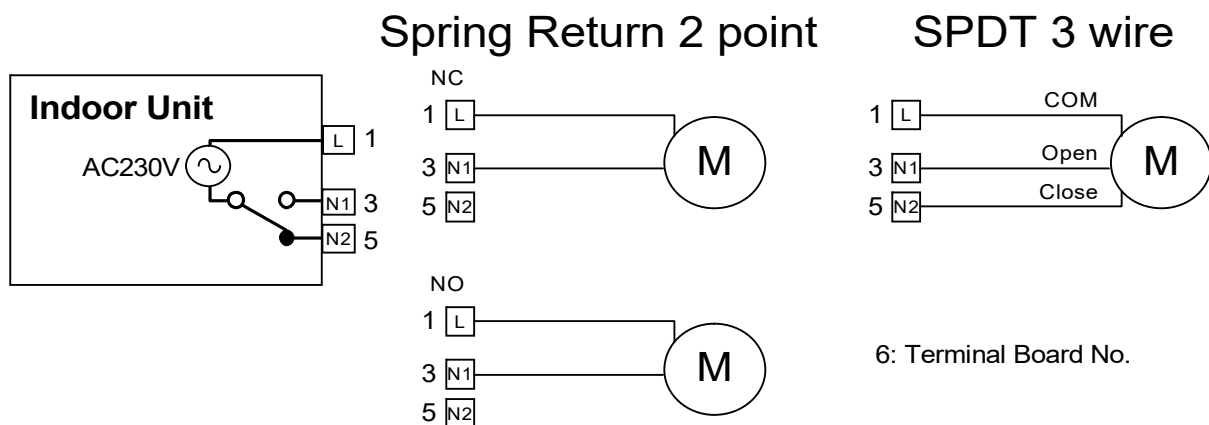

* During pump down and force mode, fix 3 ways valve in close condition.

* Recommended Parts : SFA 21/18 (Siemens)

12.18 Two Ways Valve Control

Functionality of 2 ways valve:

- Use to allow hot water to floor heating panel or block cold water to floor heating panel.

Control contents:

- 1 When indoor running in heat mode, OPEN the 2 ways valve.
- 2 When indoor running in cool mode, CLOSE the 2 ways valve.
- 3 Stop condition:
 - a. During stop mode, fix 2 ways valve in close condition.

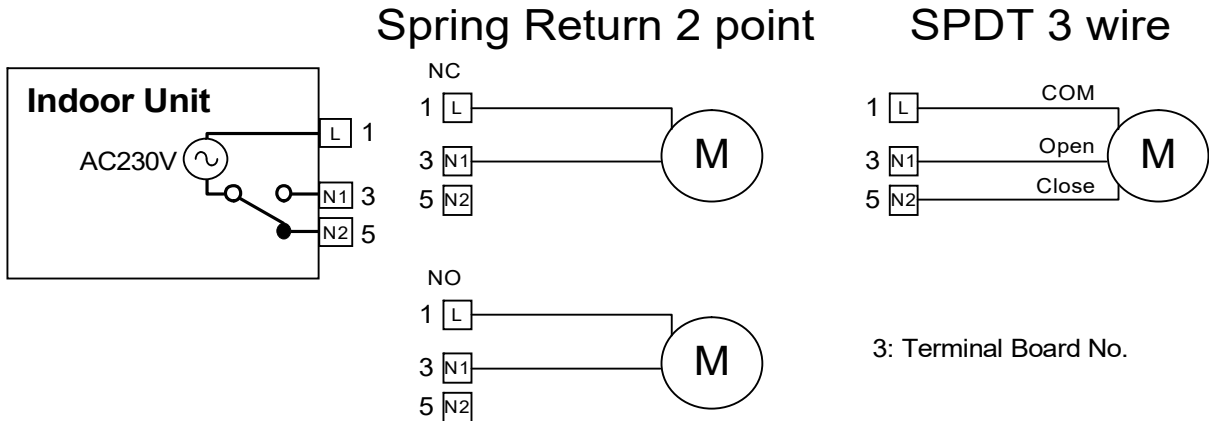

- * During pump down mode, fix 2 ways valve in close condition.
- * During force mode, open 2 ways valve.

* Recommended Parts : SFA 21/18 (Siemens)

12.19 External OFF/ON Control

- Communication circuit between indoor unit and external controller is as per beplow.

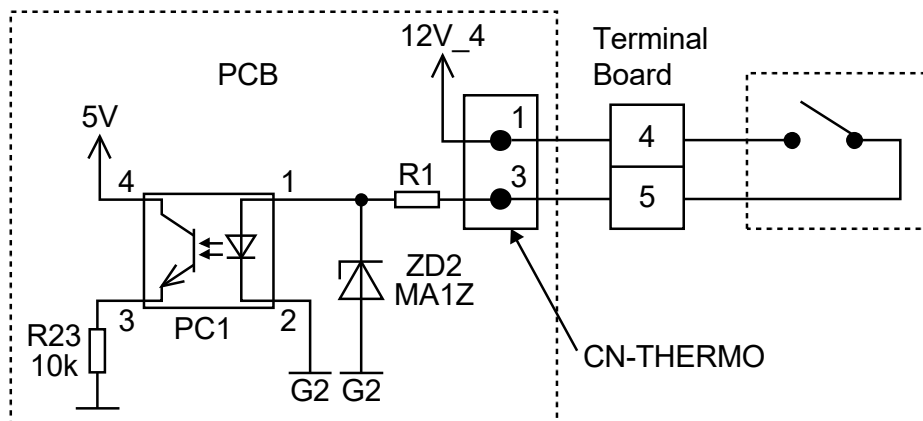

- Maximum length of communication cable is 20 meter.
- Control content:

External Control Switch	Control Panel OFF/ON	Control Panel Power LED	System Status
ON	ON	ON	ON
ON	OFF	OFF	OFF
OFF	ON	ON	OFF
OFF	OFF	OFF	OFF

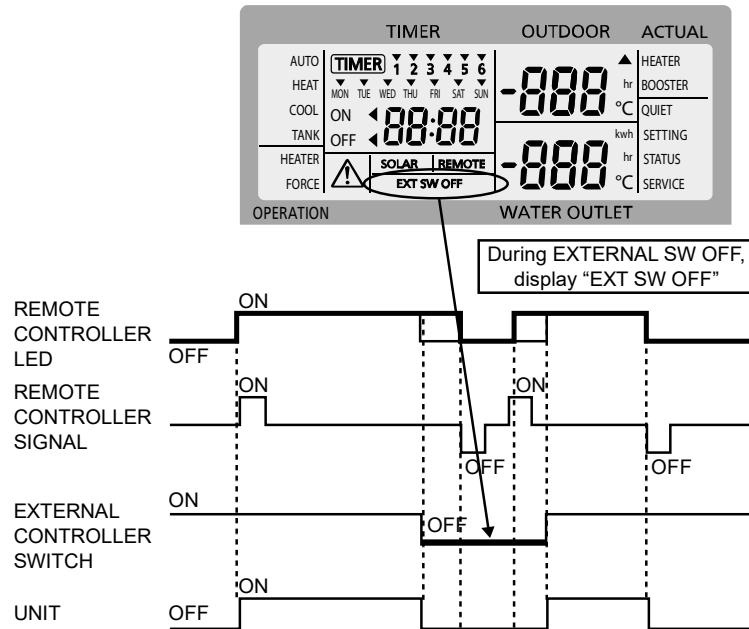

* During External Switch OFF condition, it is allow to change the setting and also timer operation.

12.20 Holiday Mode

- Purpose:
 - Promotes energy saving by allowing the user to stop the system during holiday and enables the system to resume at the preset temperature after holiday.
- Control details:
 - Range of days can be set in holiday mode is from 1 to 999 days.
 - After days of holiday have been set, heat pump will stop and only resume operation at 12.00am at the end of holiday countdown.
- Start condition:
 - Unit is OFF and holiday mode is set.
 - * The day the holiday mode was set is counted as day 1.
- Stop condition:
 - OFF/ON button is pressed.
 - Holiday counter is reached.

12.21 Dry Concrete Function

- Purpose
 - Provide heat to floor heating panel and dry the wet concrete during installation.
- Setting condition:
 - Dry concrete parameter can be set through control panel by selecting dry concrete menu.
 - Parameters are possible to set up to 99 days with different target set temperature.
- Control details:
 - Dry concrete operation can be activate under Service Mode 3.
 - Once dry concrete function start, day 1 setting temperature will be send to indoor unit by control panel.
 - Unit will operate heat mode with dry concrete preset water outlet temperature. (No shift value added to the preset water outlet temperature)
 - After complete day 1 setup operation, day 2 data will be send to indoor at 12.00am on the second day.
 - Each preset data will be send everyday until dry concrete mode is complete, unit will turns OFF and exit dry concrete function.
 - 3 ways valve and booster heater will turn OFF and 2 ways valve will turns ON.
- Cancel condition:
 - Unit will turns OFF and exit dry concrete function.
 - OFF signal is received by pressing OFF/ON button or error H76 is occurred.

13. Protection Control

13.1 Protection Control for All Operations

13.1.1 Time Delay Safety Control

- 1 The compressor will not start for three minutes after stop of operation.

13.1.2 30 Seconds Forced Operation

- 1 Once the compressor starts operation, it will not stop its operation for 30 seconds.
- 2 However, it can be stopped using control panel at indoor unit.

13.1.3 Total Running Current Control

- 1 When the outdoor running current exceeds X value, the compressor frequency will decrease.
- 2 If the outdoor running current does not exceed X value, the compressor frequency will return to normal operating frequency.
- 3 If the outdoor running current continue to increase till exceed Y value, compressor will stop, and if this occurs 3 times within 20 minutes, system will stop operation and OFF/ON control panel LED will blink (F16 error occurs).

Operation Mode	UX09FE5		UX12FE5		UD12FE5		UD16FE5	
	X (A)	Y (A)	X (A)	Y (A)	X (A)	Y (A)	X (A)	Y (A)
Heating	24.1	30.0	28.1	30.0	24.1	28.0	26.1	28.0
Cooling	16.4	30.0	18.1	30.0	16.4	28.0	22.8	28.0

A. DC Peak Current Control

- 1 When the current to IPM exceeds set value of 34 A, compressor will stop. Compressor will restart after three minutes.
- 2 If the set value exceeds again for more than 30 seconds after the compressor restarts, operation will restart after two minutes.
- 3 If the set value exceeds again for within 30 seconds after the compressor restarts, operation will restart after one minute. If this condition repeats continuously for seven times, system will stop operation and OFF/ON control panel LED will blink (F23 error occurs).

13.1.4 Compressor Overheating Prevention Control

- The compressor operating frequency is regulated in accordance to compressor tank temperature as shown in below figures. When the compressor tank temperature exceeds 107°C, compressor will stop, and if this occurs 4 times within 30 minutes, system will stop operation and OFF/ON control panel LED will blink (F20 error occurs).

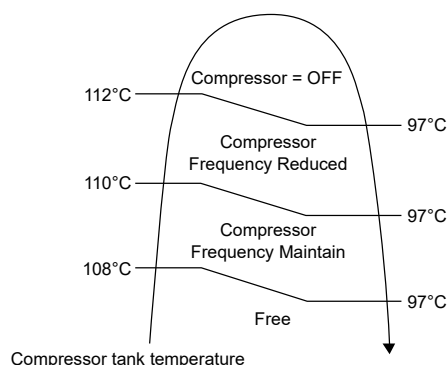

13.1.5 High Pressure Sensor Control

- Purpose:
 - To protect the system operation.
- Detection period:
 - After compressor on for 1 minute.
- Detection conditions:
 - When abnormal high voltage detection, 5 V or when open circuit detection 0V for 5 seconds continuously.
- After detection:
 - When abnormality is detected 4 times within 120 minutes, unit stop operation.
 - OFF/ON control panel LED will blink (H64 error occurs).

13.1.6 Outside Temperature Current Control

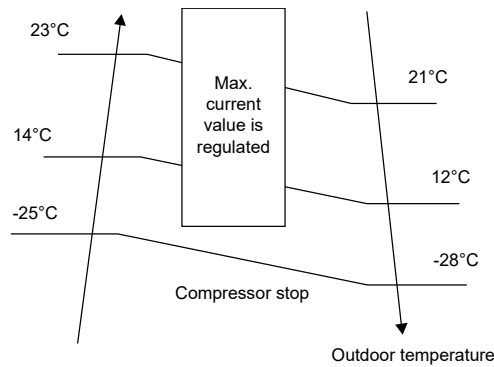

13.1.7 Crank Case Heater Control

- Purpose:
 - For compressor protection during low outdoor ambient operation (during heating low temperature operation).
- Control content:
 - a. Trigger heater START condition
 - When the outdoor air temperature is below than 5°C, and discharge temperature is 11°C or below.
 - b. Resetting heater STOP condition
 1. When the outdoor air temperature exceeds entry condition (2°C)
 2. When the discharge temperature exceeds entry condition (5°C)

13.1.8 Heat Exchanger (HEX) Protection Control

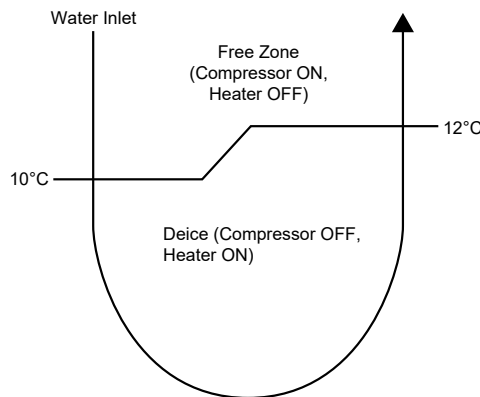

Start Condition:

- When outdoor ambient temperature is less than 10°C.

Control Details:

- Heater will turn ON and heat pump turn OFF when water inlet temperature below 10°C.
- Heater will turn OFF and heat pump turn ON when water inlet temperature increase more than 12°C.

End Condition:

- When outdoor ambient temperature is more than 13°C.

However this control will take place 29 minutes after compressor restart.

13.2 Protection Control for Heating Operation

13.2.1 Outdoor Air Temperature Control

The maximum current value is regulated when the outdoor air temperature rises above 14°C in order to avoid compressor overloading.

13.2.2 Deice Operation

When outdoor pipe temperature and outdoor air temperature is low, deice operation start where outdoor fan motor stop.

- Deice judging condition

Outdoor Unit Deice Control

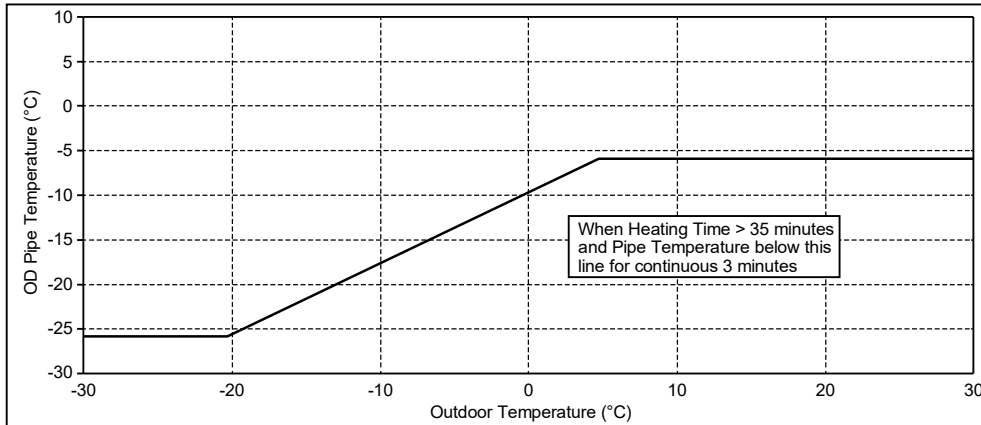

Deice start depends:

1. Outdoor air sensor temp.
2. Outdoor pipe sensor temp.
3. Heating accumulation time

- Deice mode selection condition

- There are 2 deice modes, according to water inlet temperature and outdoor ambient temperature the deice mode is decided.

Water inlet temperature

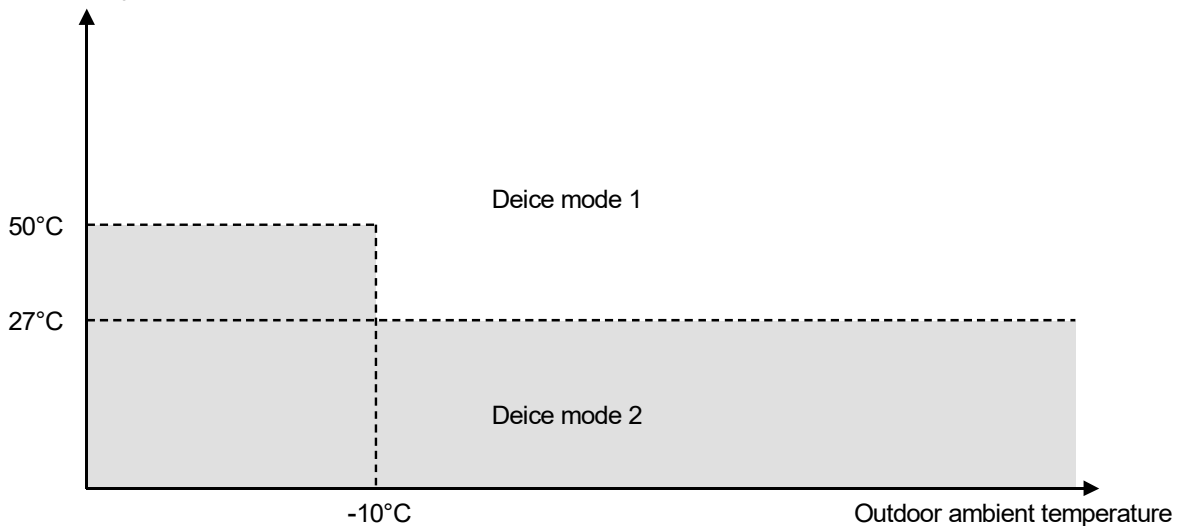

Judgement details:

- 1) When water inlet temperature is more than 50°C, unit will operate deice mode 1.
- 2) When water inlet temperature is less than 27°C, unit will operate deice mode 2.
- 3) When water inlet temperature is less than 50°C and outdoor ambient temperature is less than -10°C, unit will operate deice mode 2.
- 4) When water outlet temperature sensor 2 detect temperature is less than 22°C, unit will operate deice mode 2.

- Deice operation time diagram

- a. Deice mode 1 control:

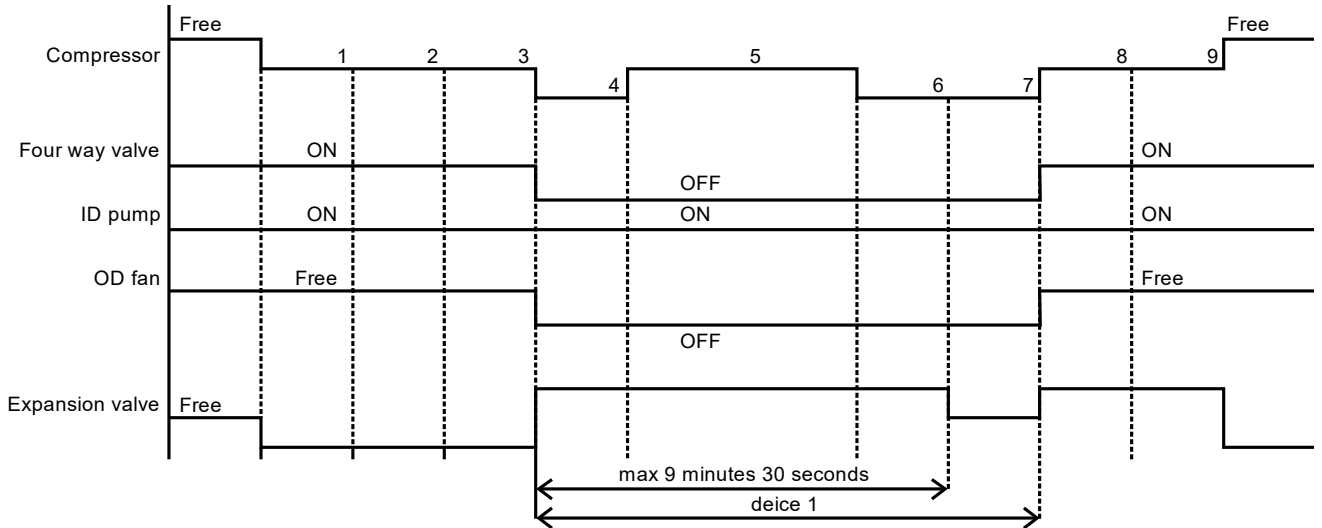

- b. Deice mode 2 control:

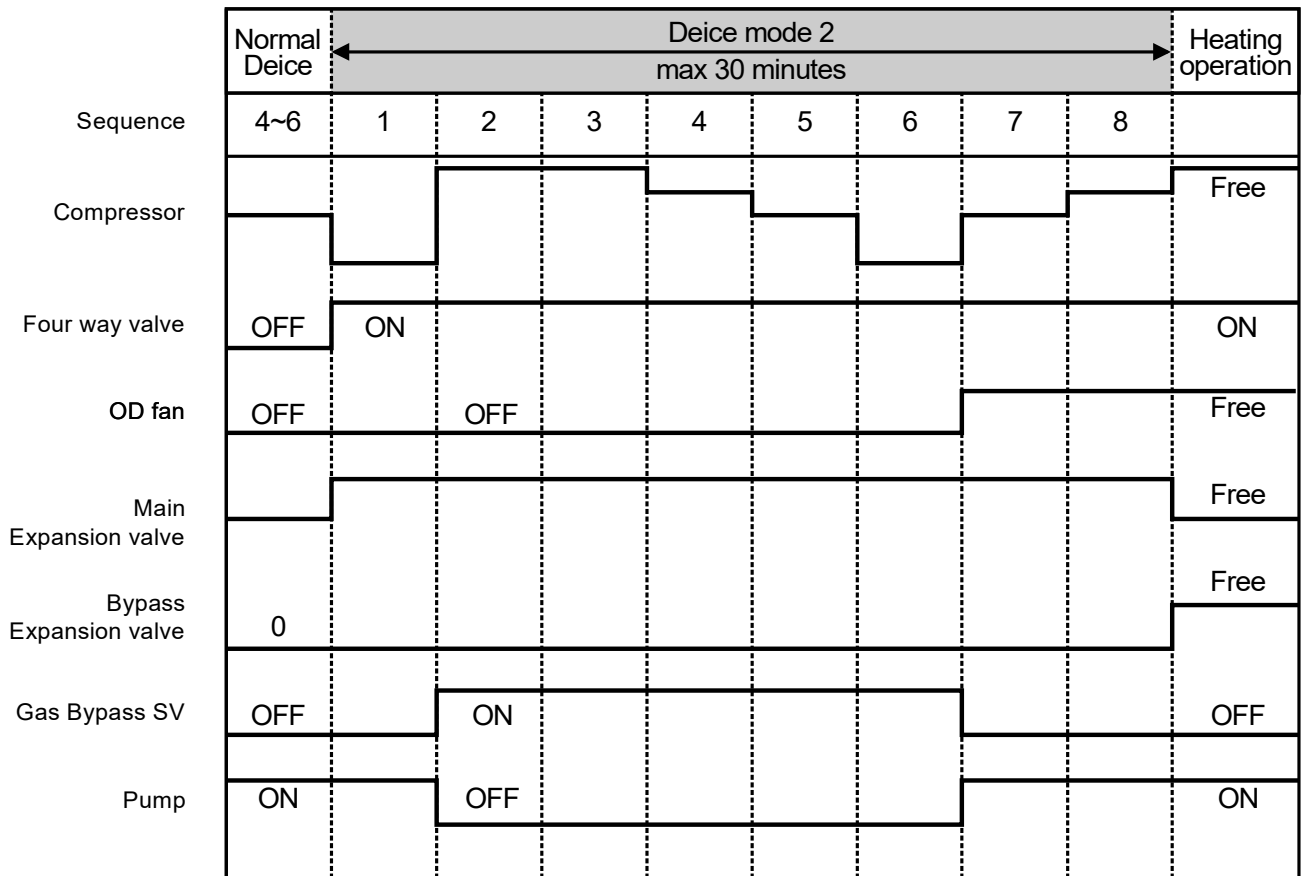

13.3 Protection Control for Cooling Operation

13.3.1 Outdoor Air Temperature Control

- The Compressor operating frequency is regulated in accordance to the outdoor air temperature as shown in the diagram below.
- This control will begin 1 minute after the compressor starts.
- Compressor frequency will adjust base on outdoor air temperature.

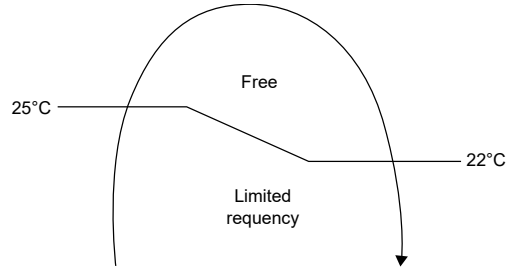

13.3.2 Freeze Prevention Control 1

- 1 When indoor heat exchanger temperature is lower than 0°C continuously for 10 seconds, compressor will stop operating.
- 2 Compressor will resume its operation three minutes after the indoor heat exchanger is higher than 1°C.
- 3 Indoor heat exchanger freeze prevention (H99) will memory in error history.

14. Servicing Guide

14.1 Open and Close Top Front Plate

- 1 Do not open or close the top front cabinet by excessive force.
- 2 Follow below illustrations to open / close the Top Front Plate.

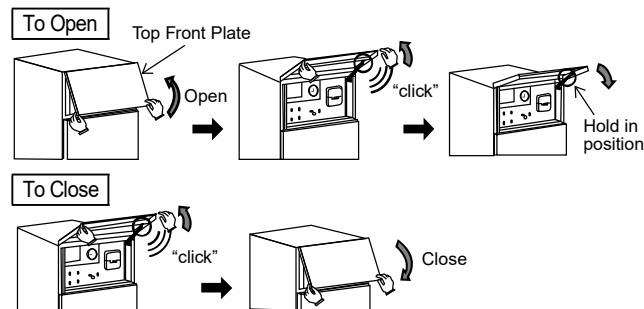

14.2 How to take out Bottom Front Plate

Open and Close Bottom Front Panel

- 1 Must open the Top Front Plate before access Bottom Front Plate.
- 2 Remove the 5 mounting screws of Bottom Front Plate.
- 3 Slide it upwards to unhook the Bottom Front Plate hooks and slots.
- 4 Reverse above steps 1~3 for close it.

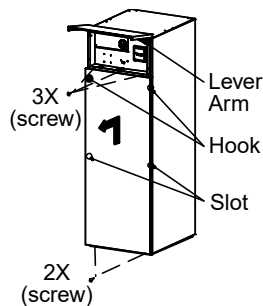

CAUTION

When open or close the Top Front Plate, make sure it is securely hold in position. Else, it may fall and injures the fingers or palms.

Open or close the Bottom Front Plate carefully. The heavy Bottom Front Plate may injures the fingers.

14.3 Test Run

- 1 Before test run, make sure below items have been checked:-
 - Pipework are properly done.
 - Electric cable connecting work are properly done.
 - Tank Unit is filled up with water and trapped air is released.
 - Please turn on the power supply after filling the tank until full.
 - In order to check whether the tank is full, switch heater once for about 10 min.
- 2 Switch ON the power supply of the Tank Unit. Set the Tank Unit RCCB / ELCB to "ON" condition. Then, please refer to the Operation Instruction for operation of Control Panel.
- 3 For normal operation, Water Pressure Gauge reading should be in between 0.05 MPa and 0.3 MPa. If necessary, adjust the Water Pump SPEED accordingly to obtain normal water pressure operating range. If adjust Water Pump SPEED cannot solve the problem, contact your local authorized dealer.
- 4 After test run, please clean the Water Filter Set. Reinstall it after finish cleaning.

14.3.1 System Capacity Rank Setting

Before Tank Unit operate, its Capacity Rank have to match with connected Outdoor Unit. See below table for detail.

Model		Capacity Rank
Tank Unit	Outdoor Unit	
ADC1216*E5*	UX09*E5*	9
	UX12*E5*	12
	UD12*E5*	12
	UD16*E5*	16

The Capacity Rank can be set by Control Panel

- 1 Press SET and SERVICE buttons simultaneously for 5 seconds.
- 2 Press ▲/▼ button to select menu CAP RAN.
- 3 Press SELECT button then press ▲/▼ button to change capacity rank and press SET button to confirm the outdoor capacity rank.
- 4 Press CANCEL button and Exit to home display.

14.4 Proper Pump Down Procedure

⚠ WARNING

Strictly follow the steps below for proper pump down procedure. Explosion may occur if the steps are not followed as per sequence.

1. When the Tank Unit is not in operation (standby), press the "SERVICE" switch on the Control Panel to enter SERVICE mode.
Operate the system in Sr : 01 mode for pump down operation.
2. After 10~15 minutes, (after 1 or 2 minutes in case very low ambient temperatures ($< 10^{\circ}\text{C}$)), fully close 2 way valve on Outdoor Unit.
3. After 3 minutes, fully close 3 way valve on Outdoor Unit.
4. Press the "OFF/ON" switch on the Control Panel to stop pump down operation.
5. Remove the refrigerant piping.

14.5 Adjust Water Flow Rate with Water Pump

Before adjust the water flow rate, make sure that the total water volume in the installation is 50 litres minimum for heating side. The default Water Pump speed is SPEED 4. Adjust the water flow rate according to connected outdoor unit model.

Please ensure the flow rate is not less than 13 L/min and not more than 50 L/min. The available external static pressure (kPa) in function of the water flow rate (L/min) is shown in the P-Q graph. Depend on the hydraulic system pressure loss and type, the water flow rate can be adjusted by Control Panel.

- 1 When the Tank Unit is in stop operation, press SERVICE button for 5 seconds.
- 2 Press ▲/▼ button to select menu S02 (PUMP SPEED ADJUST MODE) and press SET button to confirm the menu.
- 3 Press SELECT button then press ▲/▼ button to change pump speed and press SET button to confirm the pump speed.
- 4 Press OFF/ON button to exit PUMP SPEED ADJUST MODE.

During PUMP SPEED ADJUST MODE, we can select AIR PURGE function by pressing FORCE button. In AIR PURGE function, the pump will operate ON and OFF for 15 minutes to purge the air in the hydraulic system. AIR PURGE function will end after complete OR press the FORCE button again, and it will return back to PUMP SPEED ADJUST MODE.

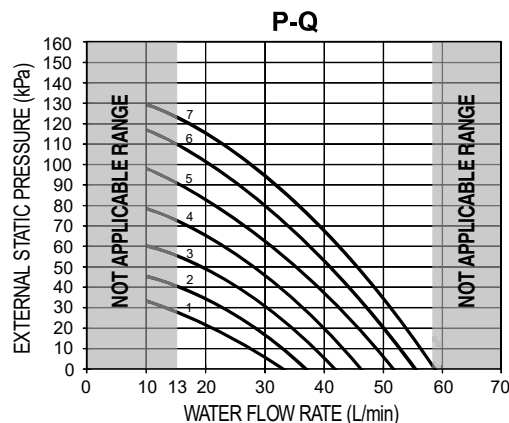

14.6 Expansion Vessel Pre Pressure Checking

For Space Heating / Cooling

- Expansion Vessel with 10 L air capacity and initial pressure of 1 bar is installed in this Tank Unit.
- Total amount of water in system should be below 200 L. (Inner volume of Tank Unit's piping is about 5L)
- If total amount of water is over 200 L, please add another expansion vessel. (field supply)
- Please keep the installation height difference of system water circuit within 10 m.

14.7 How to Unlock Cool Mode

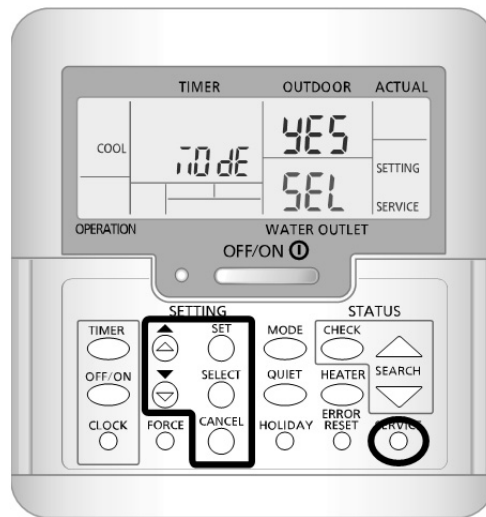

1. Press buttons SET and SERVICE for 5 seconds.
2. Press SELECT button.
3. Unlock COOL mode with ▲/▼.
4. Press SET button.

14.8 Dry Concrete [SERVICE MODE: 03]

- If Dry Concrete has been set, Dry Concrete status can be activated and monitored by following procedure.
 - 1 Press SERVICE button for 5 seconds.
 - 2 Press ▲ to enter menu Sr: 03 and press SET button to activate Dry Concrete function.
 - 3 Press OFF/ON button to quit setting.

14.9 EEPROM Factory Default Data Setup Procedure

- 1 This process should be done at Gemstar (and/or) PAPAMY as the last process after any inspection.
- 2 This condition should be activated by pressing combination of few SW's for certain time as shown.

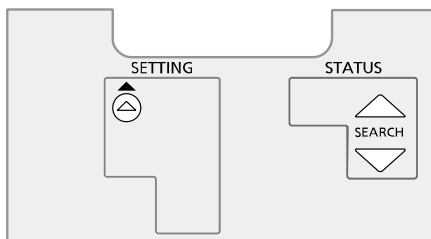

These 3 SW's should press continuously for 5secs.
(Operation should be OFF during this period)

- 3 When this condition is activated, default data should be written in EEPROM.
- 4 Once the default data is written in the EEPROM, the following full LCD display should be ON for 2secs for confirmation. After 2secs, it goes back to normal display.

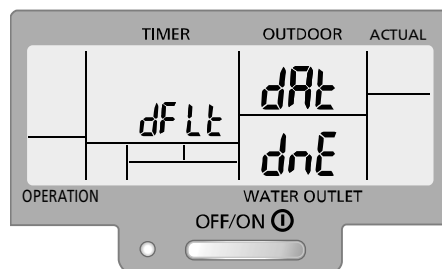

* Note: Default value, refer Location of Control and Component.

15. Maintenance Guide

In order to ensure safety and optimal performance of the Tank Unit, seasonal inspections on the Tank Unit, functional check of RCCB/ELCB, field wiring and piping have to be carried out at regular intervals. This maintenance should be carried out by authorized dealer. Contact dealer for scheduled inspection.

1 Precaution on Usage

- When using hot water, it must be mixed with water.
Please check the hot water's temperature before using it.
(Hot water may cause scalding.)
- The water quality shall be in accordance with European Council Directive 98/83 EC, or revised version at the date of installation, and is not fed with water from a private supply.
Particular: Chloride content: Max. 250 mg/l
Sulphate content: Max. 250 mg/l
Combination Chloride/sulphate: Max. 300 mg/l (in total)

2 Charging and Discharging the Water

Make sure all the piping installations are properly done before carry out below steps.

Charge the Water

- For domestic hot water tank
 - a. Set the Domestic Hot Water Tank Discharge Valve to "CLOSE".



- b. Set all Tap / Shower "OPEN".

c. Start filling water to the Domestic Hot Water Tank via Tube Connector. After 20~40min, water should flow out from Tap / Shower. Else, please contact your local authorized dealer.

d. Check and make sure no water leaking at the tube connecting points.

- For Space Heating / Cooling

a. Turn the plug on the Air Purge Valve outlet anticlockwise by one complete turn from fully closed position.

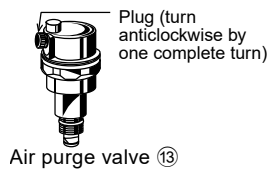

b. Set the Pressure Relief Valve level "DOWN".

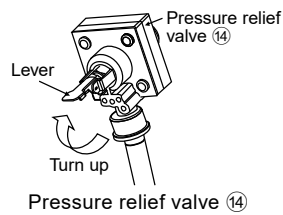

c. Start filling water (with pressure more than 0.1 MPa (1 bar)) to the Space Heating / Cooling circuit via Tube Connector. Stop filling water if the free water flow through Pressure Relief Valve Drainage.

d. Turn ON the Tank Unit and make sure Water Pump is running.

e. Check and make sure no water leaking at the tube connecting points.

Discharge the Water

- For domestic hot water tank
 - a. Turn OFF power supply.
 - b. Set the Domestic Hot Water Tank Discharge Valve to "OPEN".
 - c. Open Tap / Shower to allow air inlet.
 - d. After discharge, set Hot Water Tank Discharge Valve to "CLOSE".

- 3 Check Water Pressure *(0.1 MPa = 1 bar)
Water pressure should not lower than 0.05 MPa (with inspects the Water Pressure Gauge). If necessary add water into Tank Unit (via Tube Connector).
- 4 Check Pressure Relief Valve
 - Check for correct operation of Pressure Relief Valve by turning on the lever to become horizontal.
 - If you do not hear a clacking sound (due to water drainage), contact your local authorized dealer.
 - Push down the lever after finish checking.
 - In case the water keep on draining out from the Tank Unit, switch off the system, and then contact your local authorized dealer.
- 5 Air Purge Valve
Air purge valve must be installed at all high points in a closed water circuit system.
An automatic air purge valve is provided inside the indoor unit. To automatically purge the air from the system, turn the plug on the air outlet anticlockwise by one complete turn from fully closed position.
Excessive air is automatically purged if the plug is kept in this position.

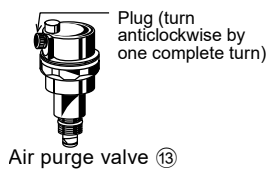

- 6 Indoor Unit Control Board Area
Thorough visual inspection of the control board and look for defects, i.e. loose connection, melting of wire insulator and etc.
- 7 RCCB/ELCB
Ensure the RCCB/ELCB set to “ON” condition before check RCCB/ELCB.
Turn on the power supply to the indoor unit.
This testing could only be done when power is supplied to the indoor unit.



WARNING

Be careful not to touch parts other than RCCB/ELCB test button when the power is supplied to Indoor Unit. Else, electrical shock may happen.

- Push the “TEST” button on the RCCB/ELCB. The lever would turn down and indicate “0” and indicate green colour if it functions normal.
 - Contact authorized dealer if the RCCB/ELCB malfunction.
 - Turn off the power supply to the indoor unit.
 - If RCCB/ELCB functions normal, set the lever to “ON” again after testing finish.
- 8 Reset Overload Protector
Overload Protector serves the safety purpose to prevent the water over heating. When the Overload Protector trip at high water temperature, take below steps to reset it.
 - a. Take out the cover.
 - b. Use a test pen to push the center button gently in order to reset the Overload Protector.
 - c. Fix the cover to the original fixing condition.

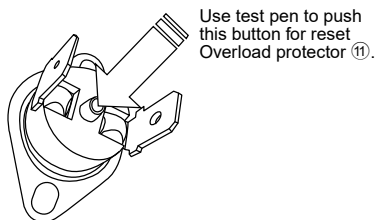

9 Maintenance for Water Filter Set

Clean the external water filter in regularly basic.

- a. Turn OFF power supply.
- b. Set the two valves for the Water Filter Set to "CLOSE".
- c. Take off the clip, then gently pull out the mesh. Beware of small amount water drain out from it.
- d. Clean the mesh with warm water to remove all the stain. Use soft brush if necessary.
- e. Reinstall the mesh to the Water Filter Set and set back the clip on it.
- f. Set the two valves for the Water Filter Set to "OPEN".
- g. Turn ON power supply.

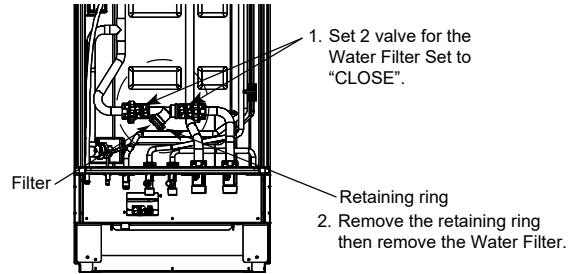

10 Maintenance for Anode Bar

To protect the tank body an anode bar is placed inside the tank. The Anode Bar will corrode, depending on the water quality. When diameter is approximate 8 mm the anode must be replaced. Examine it ONCE IN A YEAR.

- a. Turn off power supply.
- b. Close water supply valve.
- c. Manually open the Plugs (at Tube Connector ③ & ④) and drain approximate 2 litres.
- d. Take off the Top Plate with the 19 mounting screws. Be careful do not drop the Top Front Plate.
- e. Unscrew the Anode Bar (covered by insulator), check and if necessary replace.

11 Maintenance for Pressure Relief Valve (Field Supply)

It is strongly recommended to operate the Pressure Relief Valve (field supply) regularly to ensure it is not blocked and remove lime deposits.

16. Troubleshooting Guide

16.1 Refrigeration Cycle System

In order to diagnose malfunctions, make sure that there are no electrical problems before inspecting the refrigeration cycle.

Such problems include insufficient insulation, problem with the power source, malfunction of a compressor and a fan.

The normal pressure of the refrigeration cycle depends on various conditions, the standard values for them are shown in the table on the right.

Normal Pressure (Standard)

	Gas pressure MPa (kg/cm ² G)
Heating Mode	2.3 ~ 2.9 (23 ~ 29)
Cooling Mode	0.9 ~ 1.2 (9 ~ 12)

- ★ Condition:
- Outdoor temperature 7°C at heating mode and 35°C at cooling mode.
 - Compressor operates at rated frequency.

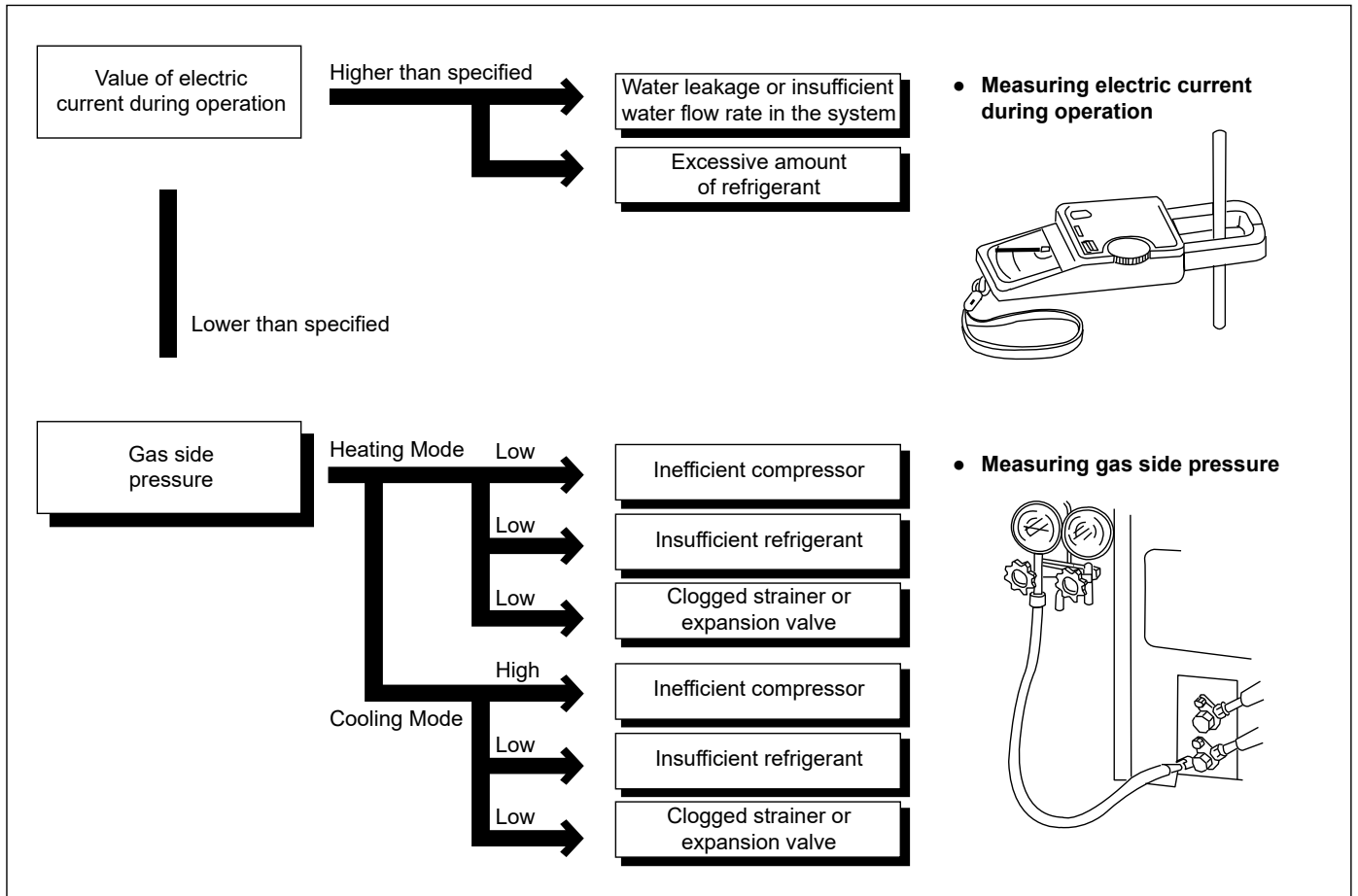

16.2 Relationship between the Condition of the Air-to-Water Hydromodule + Tank and Air-to-Water Heatpump Outdoor Units and Pressure and Electric Current

Condition of the Air-to-Water Hydromodule + Tank and Air-to-Water Heatpump outdoor units	Heating Mode			Cooling Mode		
	Low Pressure	High Pressure	Electric current during operation	Low Pressure	High Pressure	Electric current during operation
Water leakage or insufficient water flow rate in the system						
Excessive amount of refrigerant						
Inefficient compression						
Insufficient refrigerant (gas leakage)						
Outdoor heat exchange deficiency						
Clogged expansion valve or Strainer						

- Carry out the measurements of pressure, electric current, and temperature fifteen minutes after an operation is started.

16.3 Breakdown Self Diagnosis Function

16.3.1 Self Diagnosis Function (Three Digits Alphanumeric Code)

- When abnormality occur during operation, the system will stop operation, and OFF/ON control panel LED will blink and error code will display on the control panel Timer display LCD.
- Even error code is reset by turning OFF power supply or by pressing ERROR RESET button, if the system abnormality is still un-repaired, system will again stop operation, and OFF/ON control panel LED will again blink.
- The error code will store in IC memory.
- **To check the error code**
 - 1 When an abnormality occurs, system will stop operation and OFF/ON control panel LED will blink.
 - 2 Error code of the abnormality will display on the control panel Timer display LCD.
 - 3 To determine the abnormality description, the error code table needs to be referred.
- **To display past/last error code**
 - 1 Turn ON power supply.
 - 2 Press and hold the CHECK button for more than 5 seconds to enter status mode.
 - 3 Press the SEARCH DOWN/UP button to retrieve past/last error code.
 - 4 Press the CANCEL button or wait 30 seconds to exit status mode.
- **To permanently delete error code from IC memory**
 - 1 Turn ON power supply.
 - 2 Press and hold the ERROR RESET button for more than 8 seconds till a beep sound is heard.

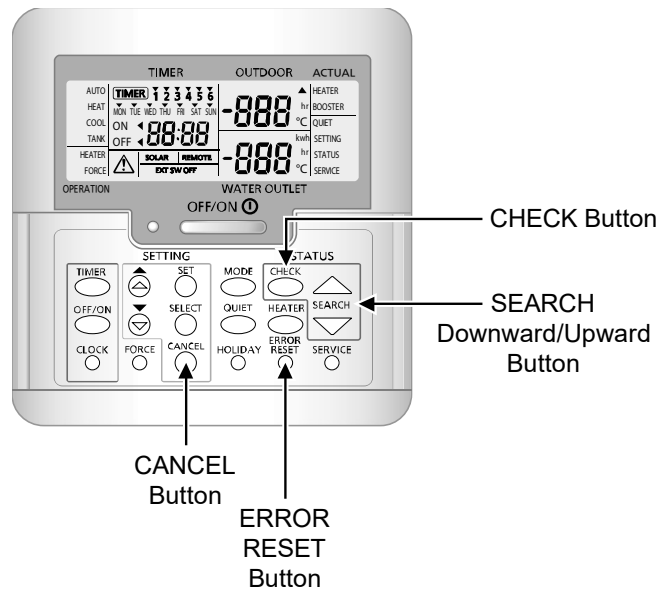

16.4 Error Codes Table

Diagnosis display	Abnormality/Protection control	Abnormality judgement	Primary location to verify
H00	No abnormality detected	—	—
H12	Indoor/Outdoor capacity unmatched	90s after power supply	<ul style="list-style-type: none"> Indoor/outdoor connection wire Indoor/outdoor PCB Specification and combination table in catalogue
H15	Outdoor compressor temperature sensor abnormality	Continue for 5 sec.	<ul style="list-style-type: none"> Compressor temperature sensor (defective or disconnected)
H20	Water pump abnormality	Continue for 10 sec.	<ul style="list-style-type: none"> Indoor PCB Water pump (malfunction)
H23	Indoor refrigerant liquid temperature sensor abnormality	Continue for 5 sec.	<ul style="list-style-type: none"> Refrigerant liquid temperature sensor (defective or disconnected)
H27	Service valve error	Continue for 5 minutes	<ul style="list-style-type: none"> High pressure sensor (defective or disconnected)
H42	Compressor low pressure abnormality	—	<ul style="list-style-type: none"> Outdoor pipe temperature sensor Clogged expansion valve or strainer Insufficient refrigerant Outdoor PCB Compressor
H62	Water flow switch abnormality	Continue for 1 min.	<ul style="list-style-type: none"> Water flow switch
*H63	Refrigerant low pressure abnormality	Continue for 5 sec.	<ul style="list-style-type: none"> Outdoor low pressure sensor (defective or disconnected)
H64	Refrigerant high pressure abnormality	Continue for 5 sec.	<ul style="list-style-type: none"> Outdoor high pressure sensor (defective or disconnected)
*H65	Deice circulation error	Continue for 10 sec.	<ul style="list-style-type: none"> Water flow switch sensor (defective or disconnected) Water pump malfunction Buffer tank (is used)
H70	Back-up heater OLP abnormality	Continue for 60 sec.	<ul style="list-style-type: none"> Back-up heater OLP (Disconnection or activated)
H72	Tank sensor abnormal	Continue for 5 sec.	<ul style="list-style-type: none"> Tank sensor
H76	Indoor - control panel communication abnormality	—	<ul style="list-style-type: none"> Indoor - control panel (defective or disconnected)
H90	Indoor/outdoor abnormal communication	> 1 min after starting operation	<ul style="list-style-type: none"> Internal/external cable connections Indoor/Outdoor PCB
H91	Tank heater OLP abnormality	Continue for 60 sec.	<ul style="list-style-type: none"> Tank heater OLP (Disconnection or activated)
H95	Indoor/Outdoor wrong connection	—	<ul style="list-style-type: none"> Indoor/Outdoor supply voltage
H98	Outdoor high pressure overload protection	—	<ul style="list-style-type: none"> Outdoor high pressure sensor Water pump or water leakage Clogged expansion valve or strainer Excess refrigerant Outdoor PCB
H99	Indoor heat exchanger freeze prevention	—	<ul style="list-style-type: none"> Indoor heat exchanger Refrigerant shortage
F12	Pressure switch activate	4 times occurrence within 20 minutes	<ul style="list-style-type: none"> Pressure switch
F14	Outdoor compressor abnormal revolution	4 times occurrence within 20 minutes	<ul style="list-style-type: none"> Outdoor compressor
F15	Outdoor fan motor lock abnormality	2 times occurrence within 30 minutes	<ul style="list-style-type: none"> Outdoor PCB Outdoor fan motor
F16	Total running current protection	3 times occurrence within 20 minutes	<ul style="list-style-type: none"> Excess refrigerant Outdoor PCB
F20	Outdoor compressor overheating protection	4 times occurrence within 30 minutes	<ul style="list-style-type: none"> Compressor tank temperature sensor Clogged expansion valve or strainer Insufficient refrigerant Outdoor PCB Compressor
F22	IPM (power transistor) overheating protection	3 times occurrence within 30 minutes	<ul style="list-style-type: none"> Improper heat exchange IPM (Power transistor)
F23	Outdoor Direct Current (DC) peak detection	7 times occurrence continuously	<ul style="list-style-type: none"> Outdoor PCB Compressor
F24	Refrigeration cycle abnormality	2 times occurrence within 20 minutes	<ul style="list-style-type: none"> Insufficient refrigerant Outdoor PCB Compressor low compression
F25	Cooling/Heating cycle changeover abnormality	4 times occurrence within 30 minutes	<ul style="list-style-type: none"> 4-way valve V-coil
F27	Pressure switch abnormality	Continue for 1 min.	<ul style="list-style-type: none"> Pressure switch

Diagnosis display	Abnormality/Protection control	Abnormality judgement	Primary location to verify
F30	Water outlet sensor 2 abnormality	Continue for 5 sec.	<ul style="list-style-type: none"> Water outlet sensor 2 (defective or disconnected)
F36	Outdoor air temperature sensor abnormality	Continue for 5 sec.	<ul style="list-style-type: none"> Outdoor air temperature sensor (defective or disconnected)
F37	Indoor water inlet temperature sensor abnormality	Continue for 5 sec.	<ul style="list-style-type: none"> Water inlet temperature sensor (defective or disconnected)
F40	Outdoor discharge pipe temperature sensor abnormality	Continue for 5 sec.	<ul style="list-style-type: none"> Outdoor discharge pipe temperature sensor (defective or disconnected)
F41	PFC control	4 times occurrence within 10 minutes	<ul style="list-style-type: none"> Voltage at PFC
F42	Outdoor heat exchanger temperature sensor abnormality	Continue for 5 sec.	<ul style="list-style-type: none"> Outdoor heat exchanger temperature sensor (defective or disconnected)
F43	Outdoor defrost sensor abnormality	Continue for 5 sec.	<ul style="list-style-type: none"> Outdoor defrost sensor (defective or disconnected)
F45	Indoor water outlet temperature sensor abnormality	Continue for 5 sec.	<ul style="list-style-type: none"> Water outlet temperature sensor (defective or disconnected)
F46	Outdoor Current Transformer open circuit	—	<ul style="list-style-type: none"> Insufficient refrigerant Outdoor PCB Compressor low
F48	Outdoor EVA outlet temperature sensor abnormality	Continue for 5 sec.	<ul style="list-style-type: none"> Outdoor EVA outlet temperature sensor (defective or disconnected)
F49	Outdoor bypass outlet temperature sensor abnormality	Continue for 5 sec.	<ul style="list-style-type: none"> Outdoor bypass outlet temperature sensor (defective or disconnected)
F95	Cooling high pressure overload protection	—	<ul style="list-style-type: none"> Outdoor high pressure sensor Water pump or water leakage Clogged expansion valve or strainer Excess refrigerant Outdoor PCB

16.5 Self-diagnosis Method

16.5.1 Connection Capability Rank Abnormality (H12)

Malfunction Decision Conditions:

During startup operation of cooling and heating, the capability rank of indoor checked by the outdoor is used to determine connection capability rank abnormality.

Malfunction Caused:

- 1 Wrong model interconnected.
- 2 Wrong indoor unit or outdoor unit PCB (main) used.
- 3 Faulty indoor unit or outdoor unit PCB (main).

Abnormality Judgment:

Continue for 90 seconds.

Troubleshooting:

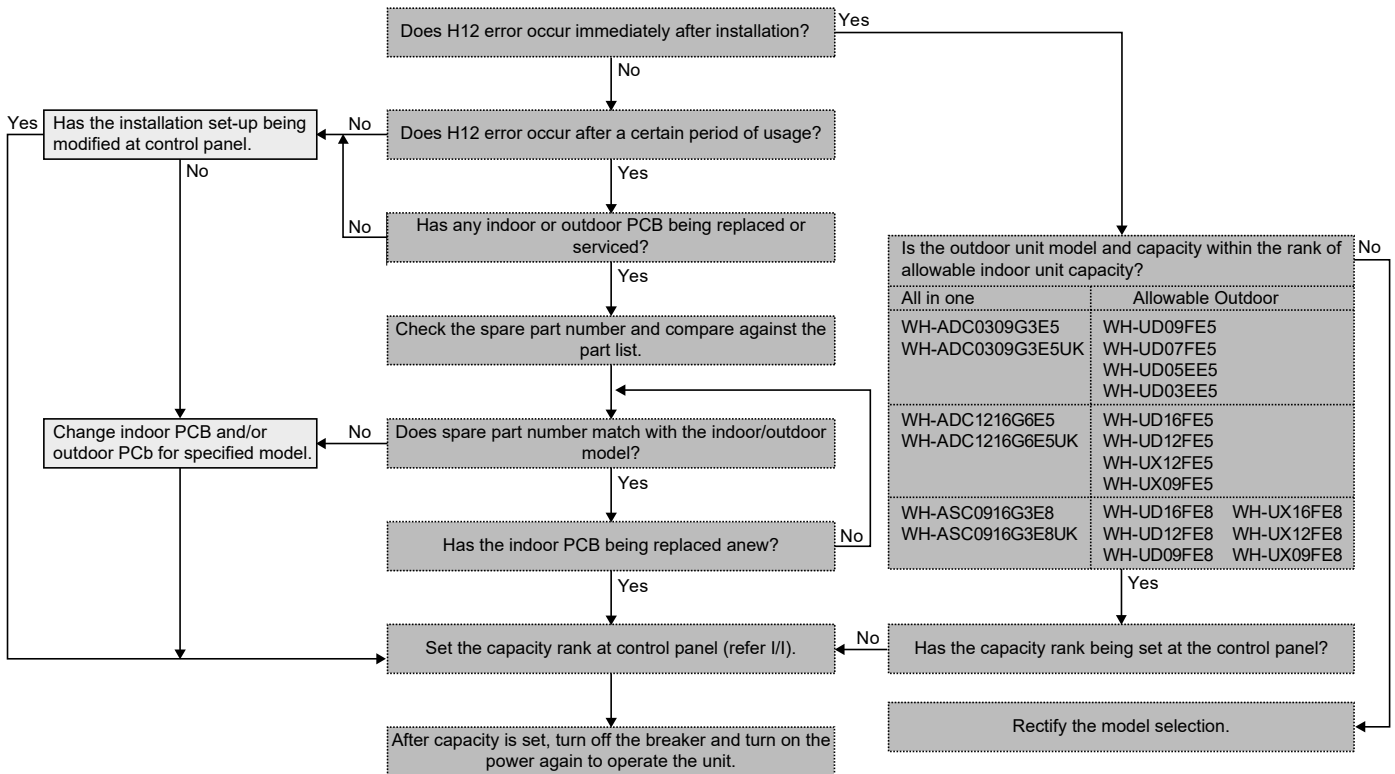

16.5.2 Compressor Tank Temperature Sensor Abnormality (H15)

Malfunction Decision Conditions:

During startup and operation of cooling and heating, the temperatures detected by the compressor tank temperature sensor are used to determine sensor error.

Malfunction Caused:

- 1 Faulty connector connection.
- 2 Faulty sensor.
- 3 Faulty outdoor unit PCB (main).

Abnormality Judgment:

Continue for 5 seconds.

Troubleshooting:

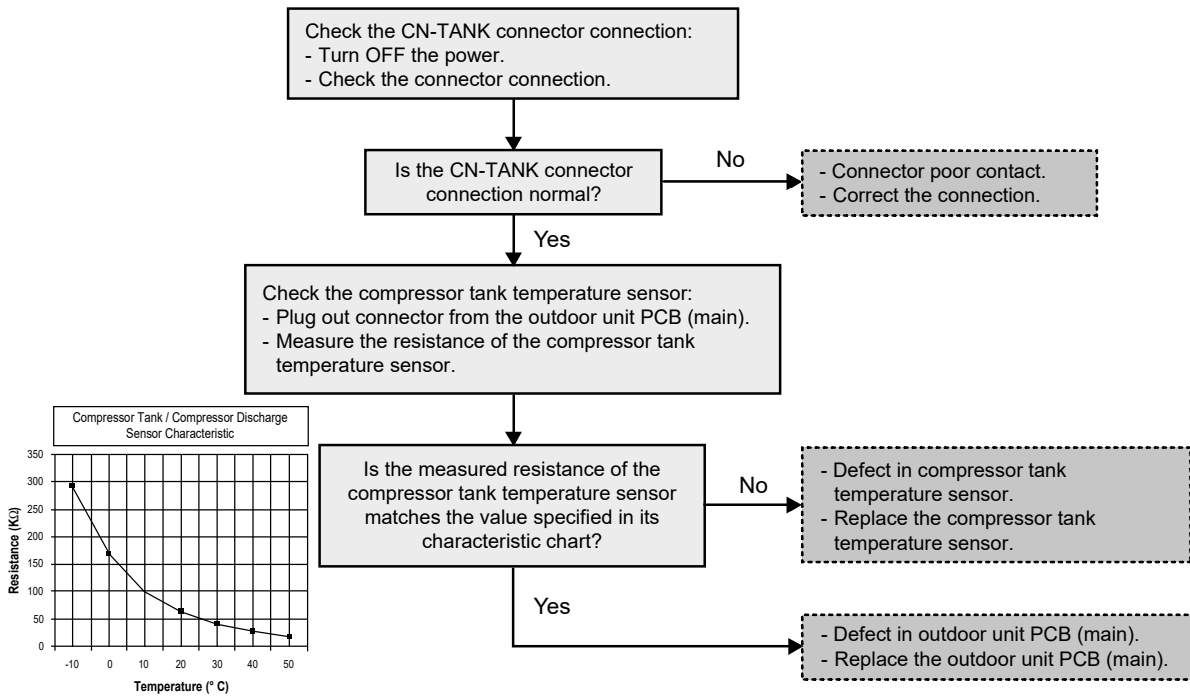

16.5.3 Water Pump Abnormality (H20)

Malfunction Decision Conditions:

During startup and operation of cooling and heating, the rotation speed detected by the IPM of water pump motor during water pump operation is used to determine abnormal water pump (feedback of rotation > 6,000rpm or < 1,000rpm).

Malfunction Caused:

- 1 Operation stop due to short circuit inside the water pump motor winding.
- 2 Operation stop due to breaking of wire inside the water pump motor.
- 3 Operation stop due to breaking of water pump lead wires.
- 4 Operation stop due to water pump motor IPM malfunction.
- 5 Operation error due to faulty indoor unit PCB.

Abnormality Judgment:

Continue for 5 seconds.

Troubleshooting:



For safety reason and to prevent component breakdown, always switch off the power before remove and connect the component.

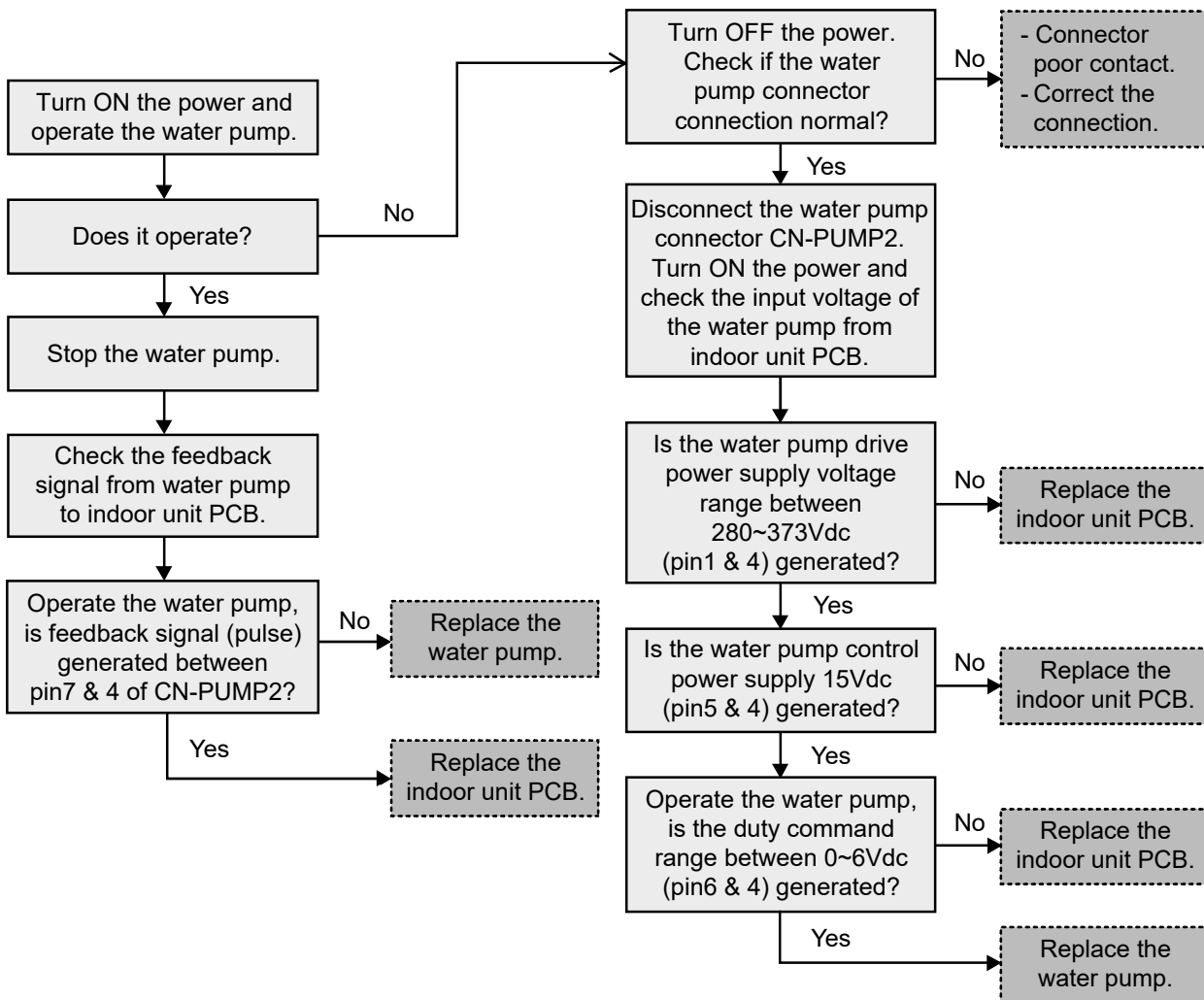

16.5.4 Indoor Refrigerant Liquid Temperature Sensor Abnormality (H23)

Malfunction Decision Conditions:

During startup and operation of cooling and heating, the temperatures detected by the indoor refrigerant liquid temperature sensor are used to determine sensor error.

Malfunction Caused:

- 1 Faulty connector connection.
- 2 Faulty sensor.
- 3 Faulty indoor unit PCB (main).

Abnormality Judgment:

Continue for 5 seconds.

Troubleshooting:



Caution

For safety reason and to prevent component breakdown, always switch off the power before remove and connect the component.

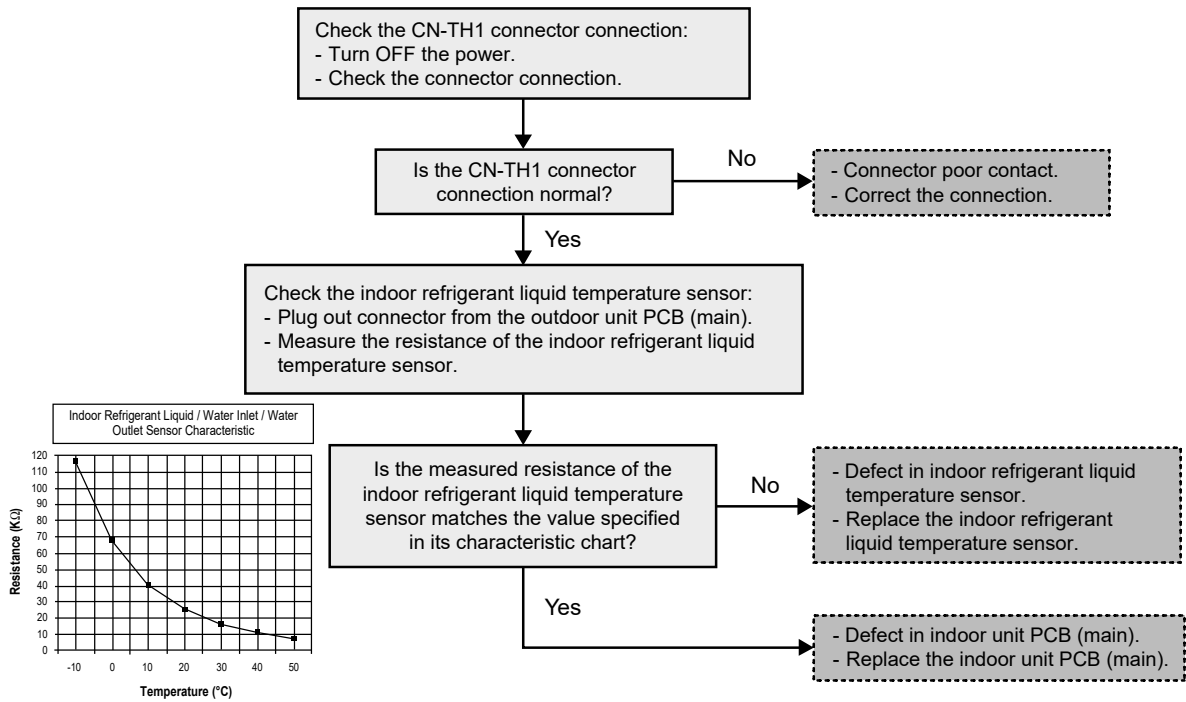

16.5.5 Service Valve Error (H27)

Malfunction Decision Conditions:

During cooling operation, when:-

[a] Indoor refrigerant pipe temperature at compressor startup - present indoor refrigerant pipe temperature $< 2^{\circ}\text{C}$

[b] Present high pressure - high pressure at compressor startup $< 5\text{kg}/\text{cm}^2$

**Judgment only for first time cooling operation and not during pump down operation.

Malfunction Caused:

- 1 3 way valves closed.
- 2 Faulty high pressure sensor.
- 3 Faulty indoor refrigerant pipe temperature sensor
- 4 Faulty outdoor unit PCB (main).

Abnormality Judgment:

Continue for 5 minutes.

Troubleshooting:



Caution

For safety reason and to prevent component breakdown, always switch off the power before remove and connect the component.

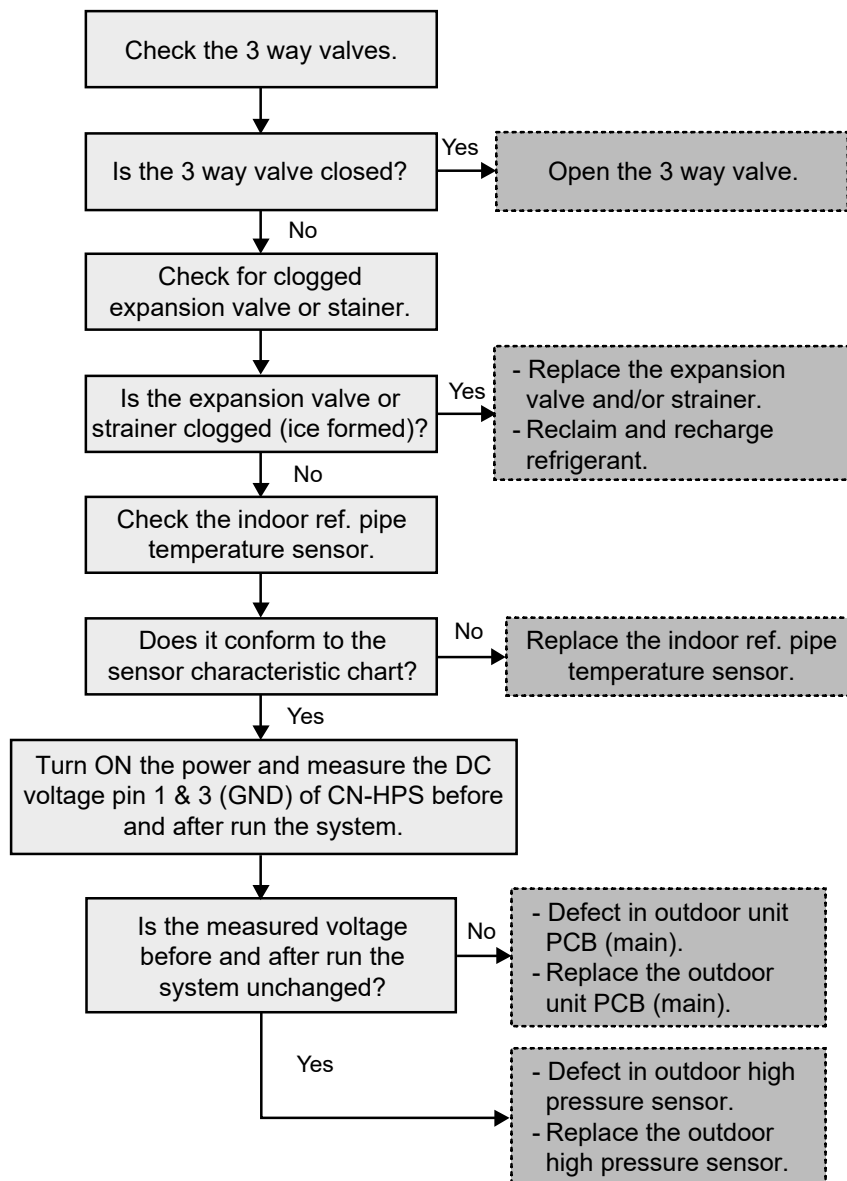

16.5.6 Compressor Low Pressure Protection (H42)

Malfunction Decision Conditions:

During operation of heating and after 5 minutes compressor ON, when outdoor pipe temperature below -29°C or above 26°C is detected by the outdoor pipe temperature sensor.

Malfunction Caused:

- 1 Dust accumulation on the outdoor unit heat exchanger.
- 2 Air short circuit at outdoor unit.
- 3 2 way valve partially closed.
- 4 Faulty outdoor unit fan motor.
- 5 Refrigerant shortage (refrigerant leakage).
- 6 Clogged expansion valve or strainer.
- 7 Faulty outdoor pipe temperature sensor.
- 8 Faulty outdoor unit main PCB (main).

Troubleshooting:



Caution

For safety reason and to prevent component breakdown, always switch off the power before remove and connect the component.

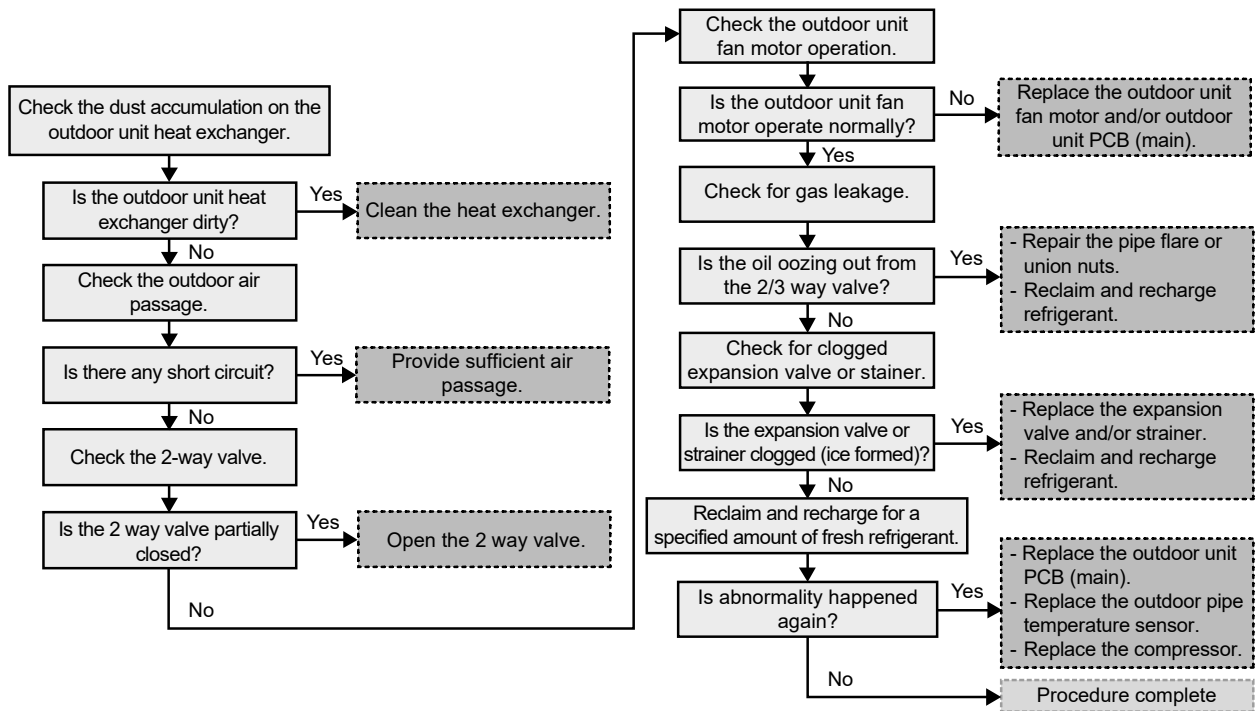

16.5.7 Water Flow Switch Abnormality (H62)

Malfunction Decision Conditions:

During operation of cooling and heating, the water flow detected by the indoor water flow switch is used to determine water flow error.

Malfunction Caused:

- 1 Faulty water pump.
- 2 Water leak in system.
- 3 Faulty connector connection.
- 4 Faulty water flow switch.
- 5 Faulty indoor unit PCB (main).

Abnormality Judgment:

Continue for 10 seconds (but no judgment for 9 minutes after compressor startup/restart).

Troubleshooting:



Caution

For safety reason and to prevent component breakdown, always switch off the power before remove and connect the component.

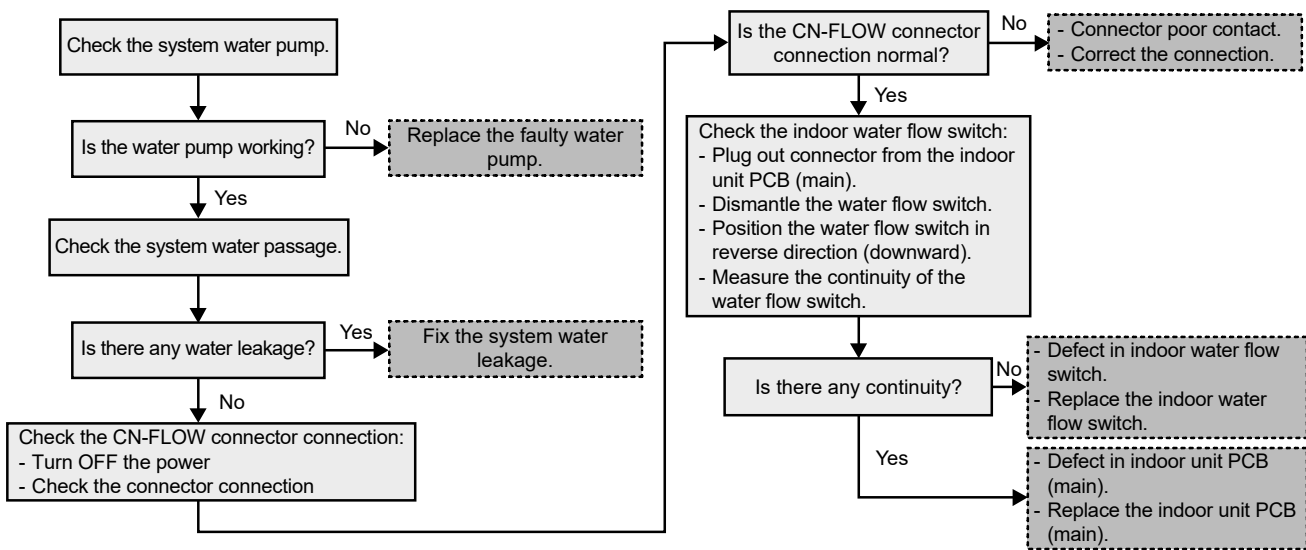

16.5.8 Outdoor High Pressure Abnormality (H64)

Malfunction Decision Conditions:

During operation of cooling and heating, when the outdoor high pressure sensor output signal is 0 Vdc or 5 Vdc.

Malfunction Caused:

- 1 Faulty connector connection.
- 2 Faulty sensor.
- 3 Faulty outdoor unit PCB (main).

Abnormality Judgment:

Continue 4 times in 20 minutes.

Troubleshooting:



Caution

For safety reason and to prevent component breakdown, always switch off the power before remove and connect the component.

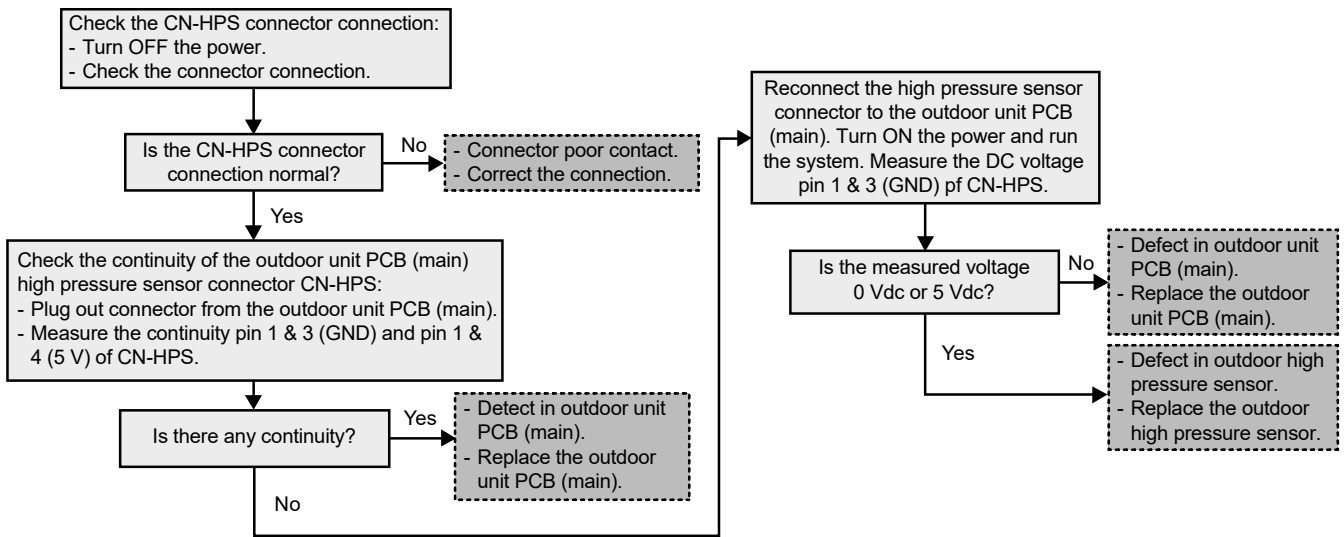

16.5.9 Deice Circulation Error (H65)

Malfunction Decision Conditions:

During deice operation, flow switch detects water flow for 10 seconds during deice.

Malfunction Caused:

- 1 Secondary pump.
- 2 Flow switch faulty.
- 3 Water pump faulty.
- 4 Indoor PCB.

Abnormality Judgment:

Continue 10 seconds.

Troubleshooting:



For safety reason and to prevent component breakdown, always switch off the power before remove and connect the component.

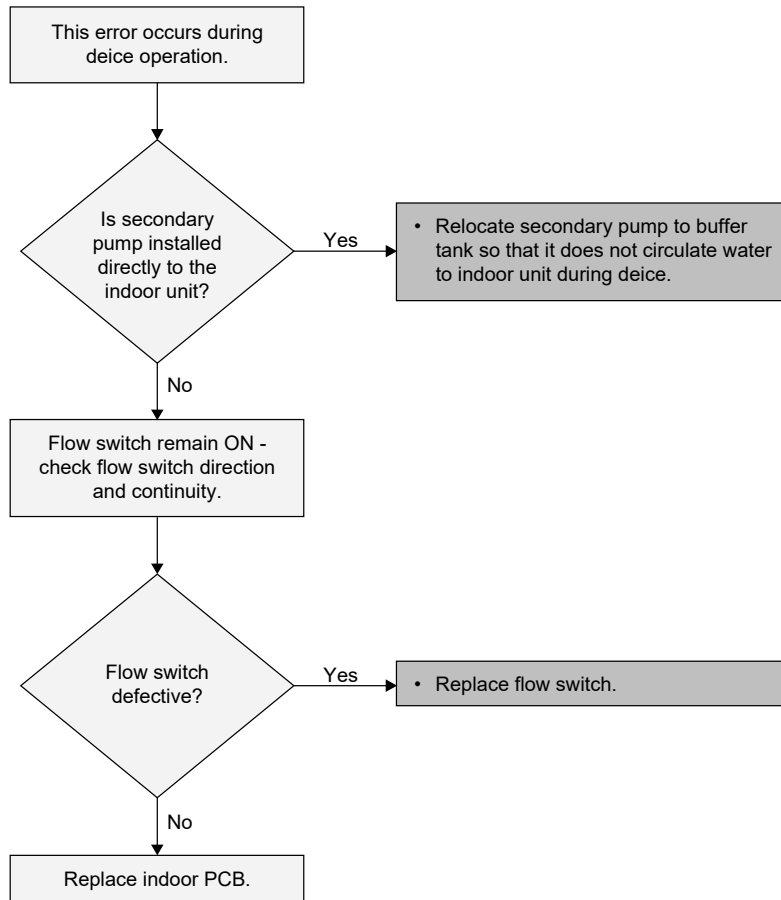

16.5.10 Indoor Backup Heater OLP Abnormality (H70)

Malfunction Decision Conditions:

During operation of indoor backup heater, when no power supplies to indoor backup heater or OLP open circuit.

Malfunction Caused:

- 1 Faulty power supply connector connection.
- 2 Faulty connector connection.
- 3 Faulty indoor backup heater overload protector (OLP).
- 4 Faulty indoor unit PCB (main).

Abnormality Judgment:

Continue for 60 seconds.

Troubleshooting:



Caution

For safety reason and to prevent component breakdown, always switch off the power before remove and connect the component.

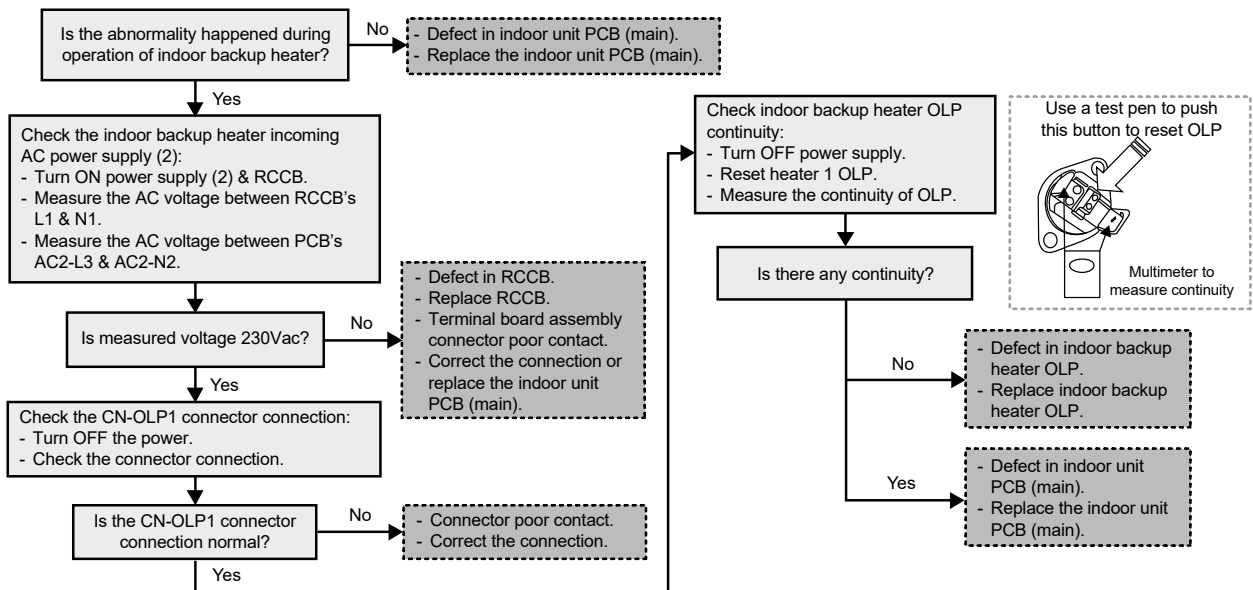

16.5.11 Tank Temperature Sensor Abnormality (H72)

Malfunction Decision Conditions:

When tank connection is set to ON, the temperatures detected by the tank temperature sensor are used to determine sensor error.

Malfunction Caused:

- 1 Faulty connector connection.
- 2 Faulty sensor.
- 3 Faulty indoor unit PCB (main).

Abnormality Judgment:

Continue for 5 seconds.

Troubleshooting:



Caution

For safety reason and to prevent component breakdown, always switch off the power before remove and connect the component.

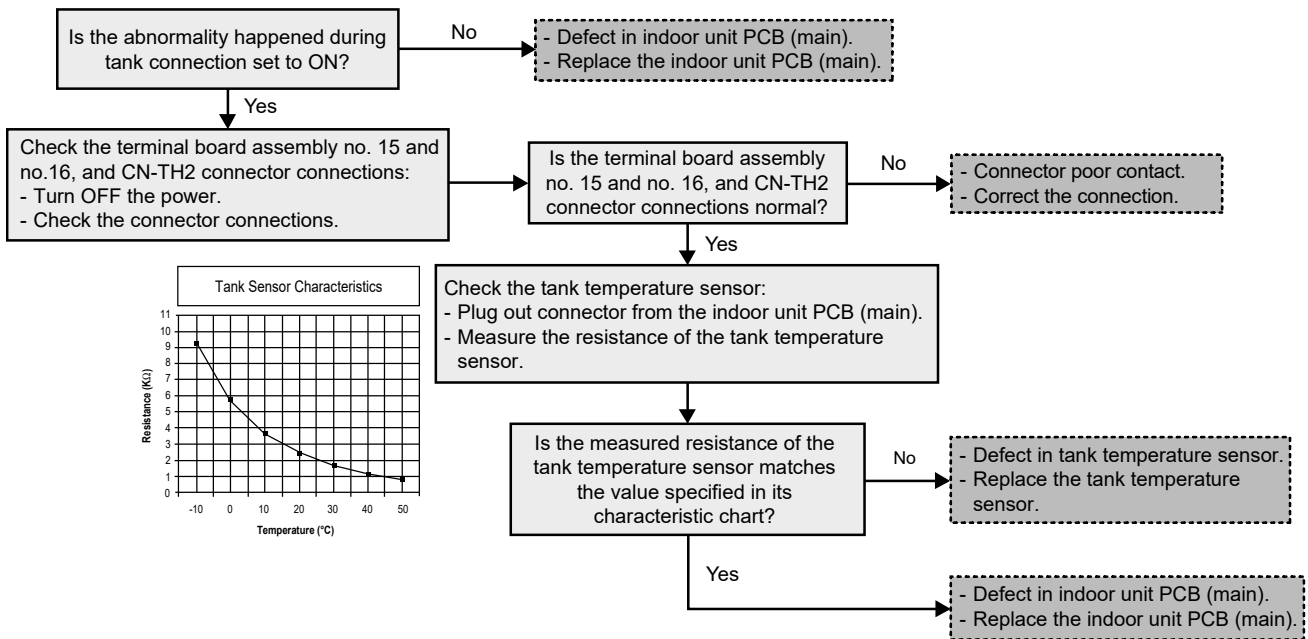

16.5.12 Indoor-Control Panel Communication Abnormality (H76)

Malfunction Decision Conditions:

During standby and operation of cooling and heating, indoor-control panel error occur.

Malfunction Caused:

- 1 Faulty connector connection.
- 2 Faulty control panel.
- 3 Faulty indoor unit PCB (main).

Troubleshooting:



For safety reason and to prevent component breakdown, always switch off the power before remove and connect the component.

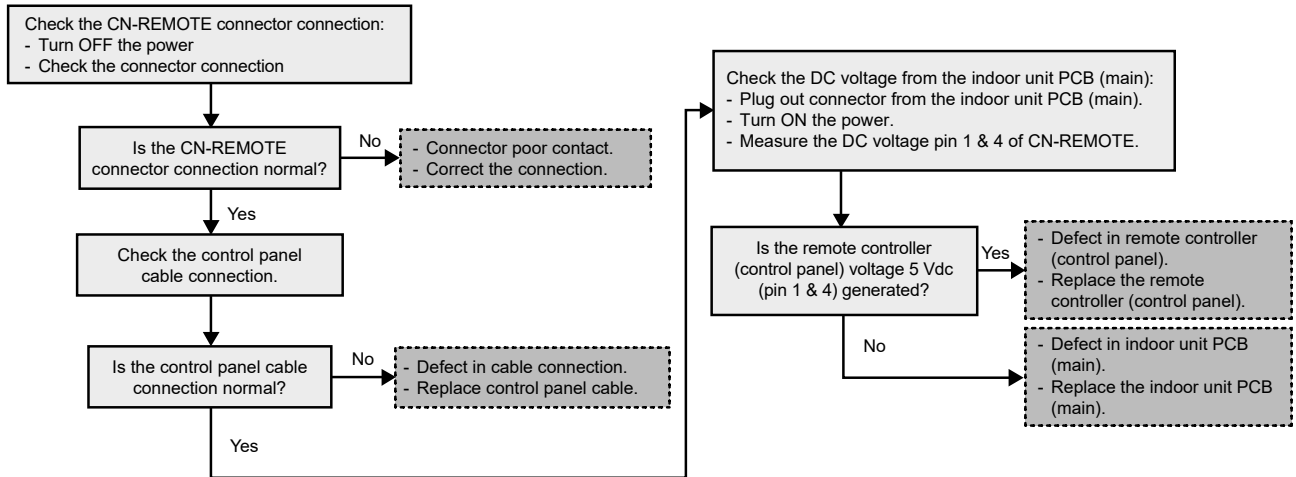

16.5.13 Indoor/Outdoor Abnormal Communication (H90)

Malfunction Decision Conditions:

During operation of cooling and heating, the data received from outdoor unit in indoor unit signal transmission is checked whether it is normal.

Malfunction Caused:

- 1 Faulty outdoor unit PCB (main).
- 2 Faulty indoor unit PCB (main).
- 3 Indoor-outdoor signal transmission error due to wrong wiring.
- 4 Indoor-outdoor signal transmission error due to breaking of wire in the connection wires between the indoor and outdoor units.
- 5 Indoor-outdoor signal transmission error due to disturbed power supply waveform.

Abnormality Judgment:

Continue for 1 minute after operation.

Troubleshooting:



For safety reason and to prevent component breakdown, always switch off the power before remove and connect the component.

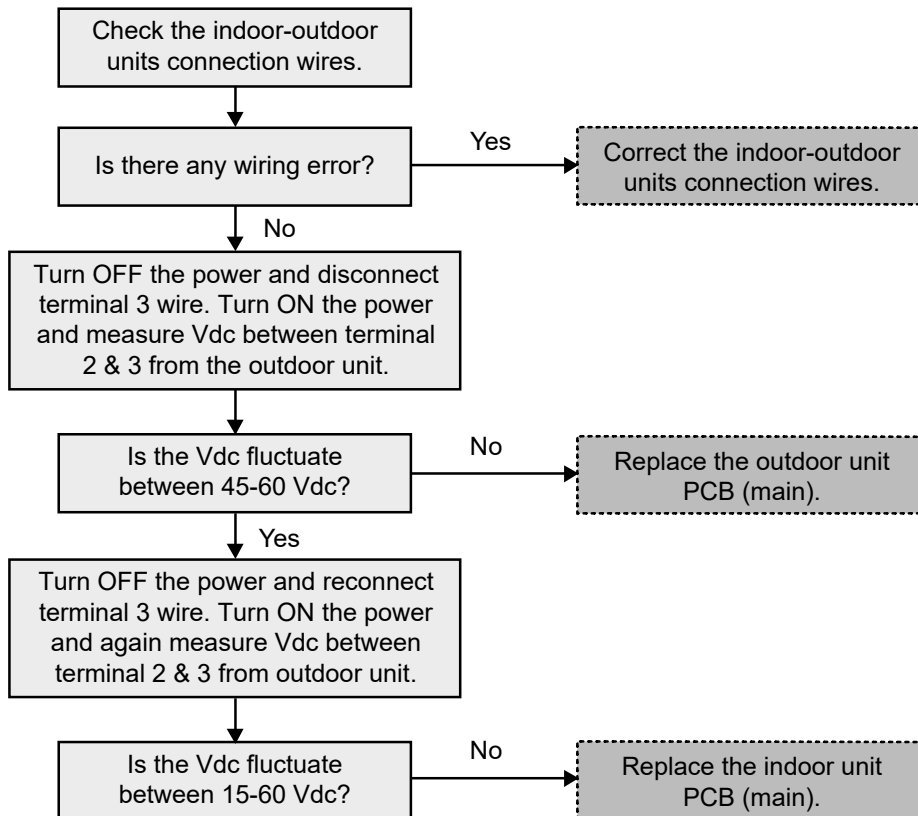

16.5.14 Tank Booster Heater OLP Abnormality (H91)

Malfunction Decision Conditions:

During operation of tank booster heater, and tank booster heater OLP open circuit.

Malfunction Caused:

- 1 Faulty connector connection.
- 2 Faulty tank booster heater overload protector (OLP).
- 3 Faulty indoor unit PCB (main).

Abnormality Judgment:

Continue for 60 seconds.

Troubleshooting:



Caution

For safety reason and to prevent component breakdown, always switch off the power before remove and connect the component.

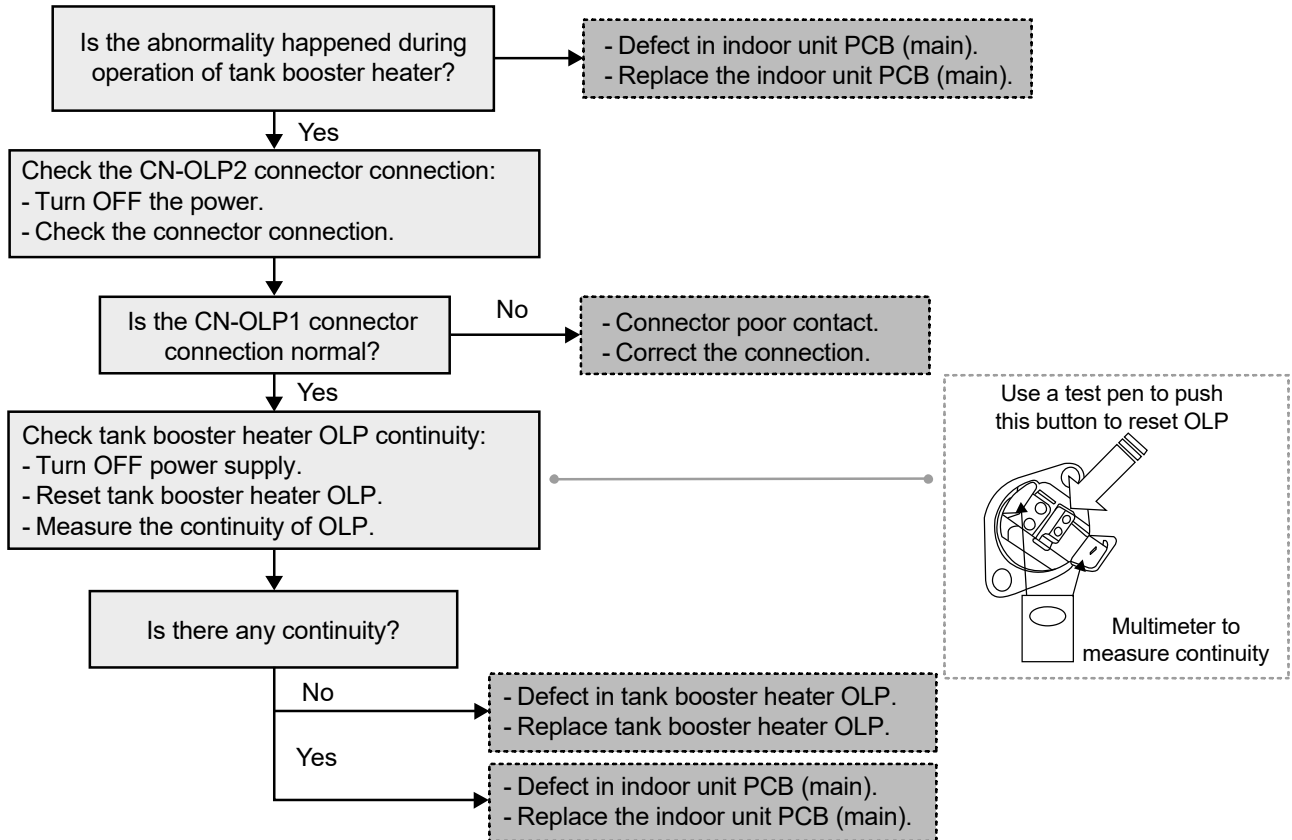

16.5.15 Unspecified Voltage between Indoor and Outdoor (H95)

Malfunction Decision Conditions:

The supply power is detected for its requirement by the indoor/outdoor transmission.

Malfunction Caused:

- 1 Insufficient power supply.
- 2 Faulty outdoor unit PCB (noise filter/main).

Troubleshooting:



For safety reason and to prevent component breakdown, always switch off the power before remove and connect the component.

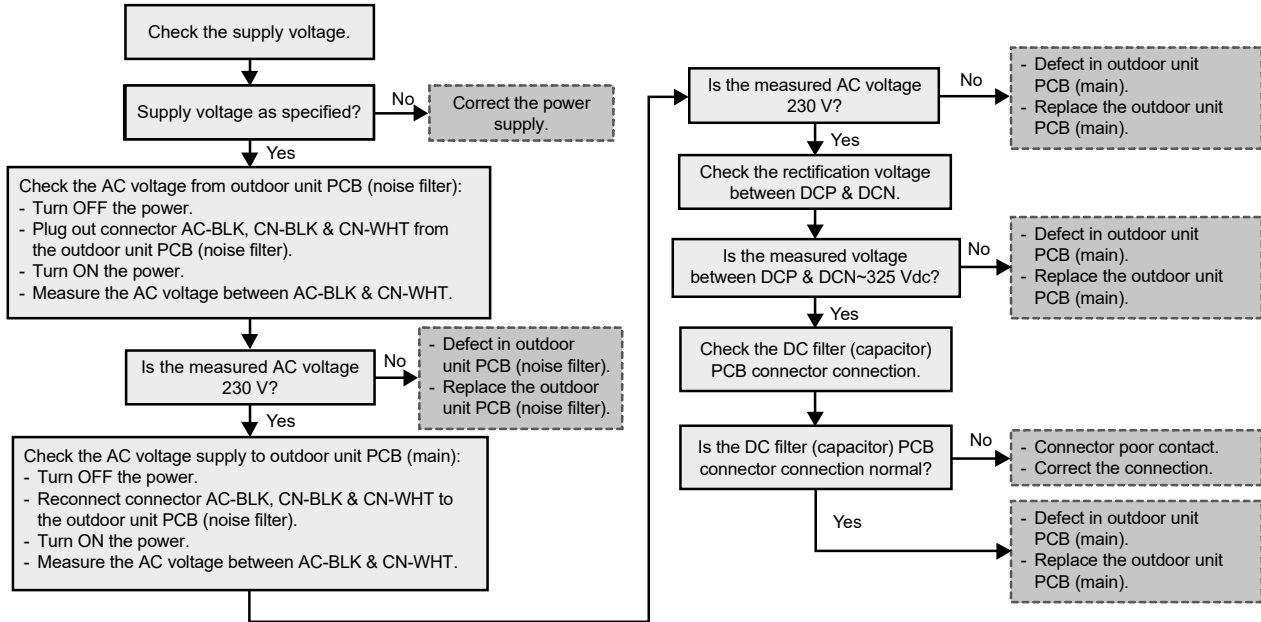

16.5.16 Outdoor Fan Motor - DC Motor Mechanism Locked (H97) (For WH-UD03EE5 WH-UD05EE5)

Malfunction Decision Conditions:

The rotation speed detected by the Hall IC during fan motor operation is used to determine abnormal fan motor.

Malfunction Caused:

- 1 Operation stops due to short circuit inside the fan motor winding.
- 2 Operation stops due to breaking of wire inside the fan motor.
- 3 Operation stops due to breaking of fan motor lead wires.
- 4 Operation stops due to Hall IC malfunction.
- 5 Operation error due to faulty outdoor unit PCB.

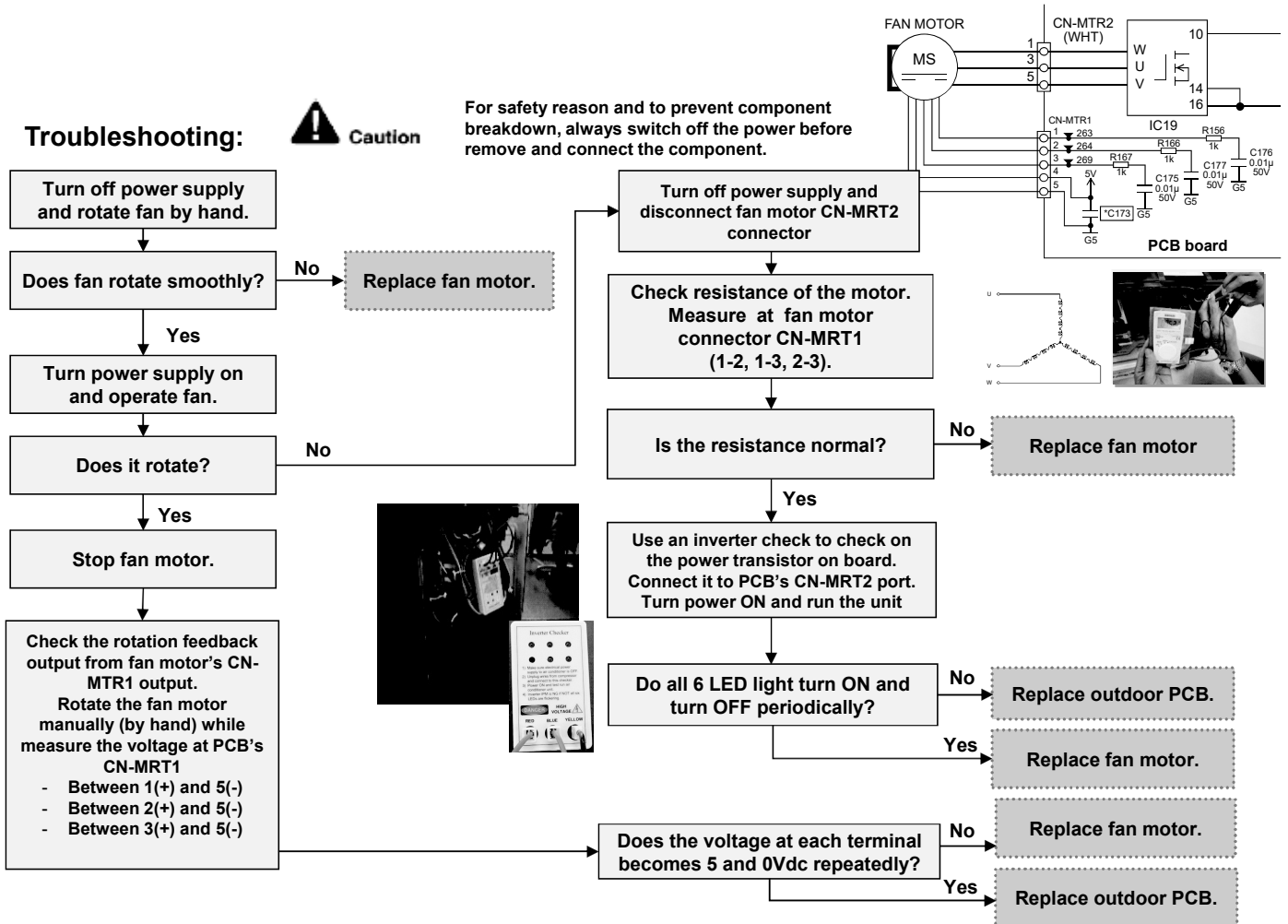

16.5.17 Outdoor Fan Motor – DC Motor Mechanism Locked (H97) (For WH-UD07FE5 WH-UD09FE5)

Malfunction Decision Conditions:

The rotation speed detected by the Hall IC during fan motor operation is used to determine abnormal fan motor.

Malfunction Caused:

- 1 Operation stops due to short circuit inside the fan motor winding.
- 2 Operation stops due to breaking of wire inside the fan motor.
- 3 Operation stops due to breaking of fan motor lead wires.
- 4 Operation stops due to Hall IC malfunction.
- 5 Operation error due to faulty outdoor unit PCB.

Troubleshooting:

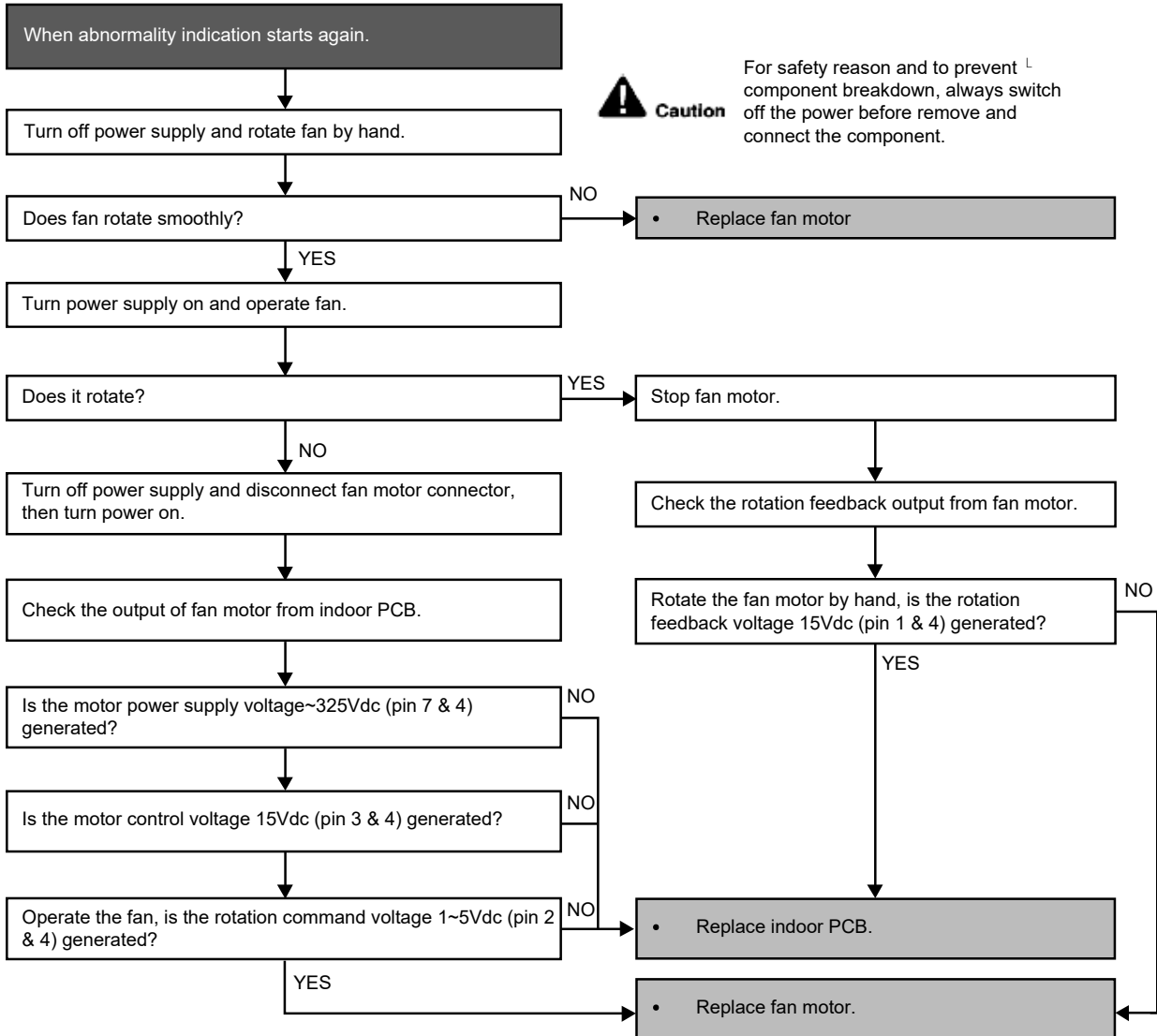

16.5.18 Outdoor High Pressure Protection (H98)

Malfunction Decision Conditions:

During operation of heating, when pressure 4.0 MPa and above is detected by outdoor high pressure sensor.

Malfunction Caused:

- 1 Faulty water pump.
- 2 Insufficient water flow rate in system.
- 3 Water leak in system.
- 4 2/3 way closed.
- 5 Clogged expansion valve or strainer.
- 6 Excessive refrigerant.
- 7 Faulty outdoor high pressure sensor.
- 8 Faulty outdoor unit PCB (main).

Troubleshooting:



Caution

For safety reason and to prevent component breakdown, always switch off the power before remove and connect the component.

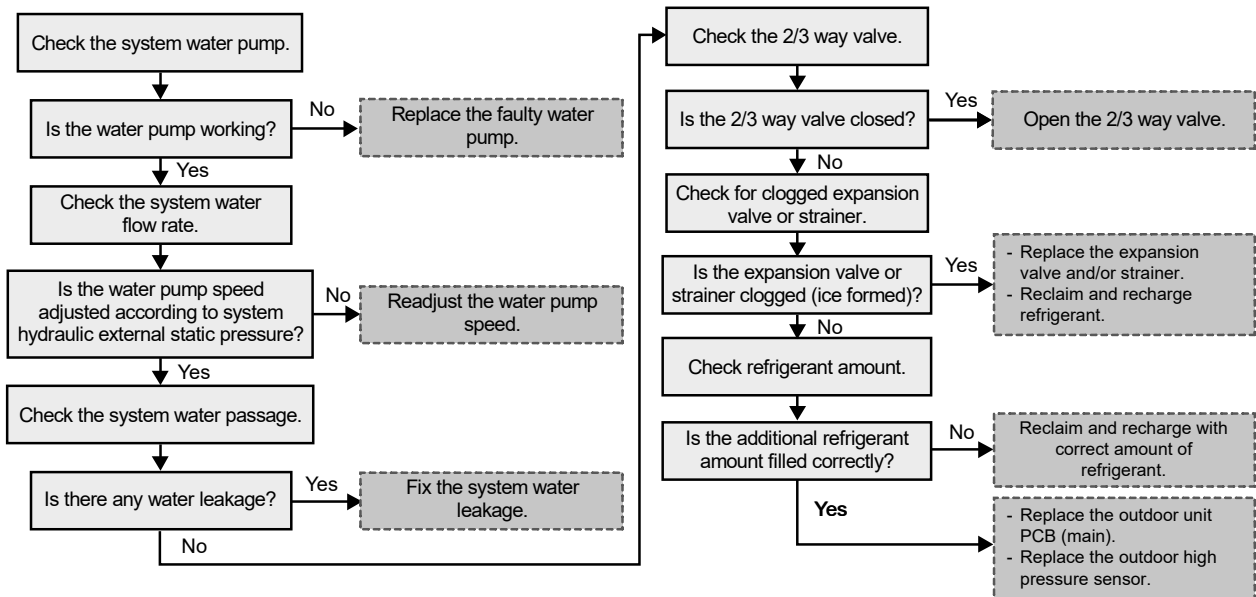

16.5.19 Indoor Freeze-up Protection (H99)

Malfunction Decision Conditions:

During anti-freezing control in cooling operation, when the indoor refrigerant liquid temperature $< 0^{\circ}\text{C}$.

Malfunction Caused:

- 1 Faulty water pump.
- 2 Insufficient water flow rate in system.
- 3 Water leak in system.
- 4 2 way valve partially closed.
- 5 Clogged expansion valve or strainer.
- 6 Refrigerant shortage (refrigerant leakage).
- 7 Faulty indoor refrigerant liquid temperature sensor.
- 8 Faulty indoor unit PCB (main).

Troubleshooting:



Caution

For safety reason and to prevent component breakdown, always switch off the power before remove and connect the component.

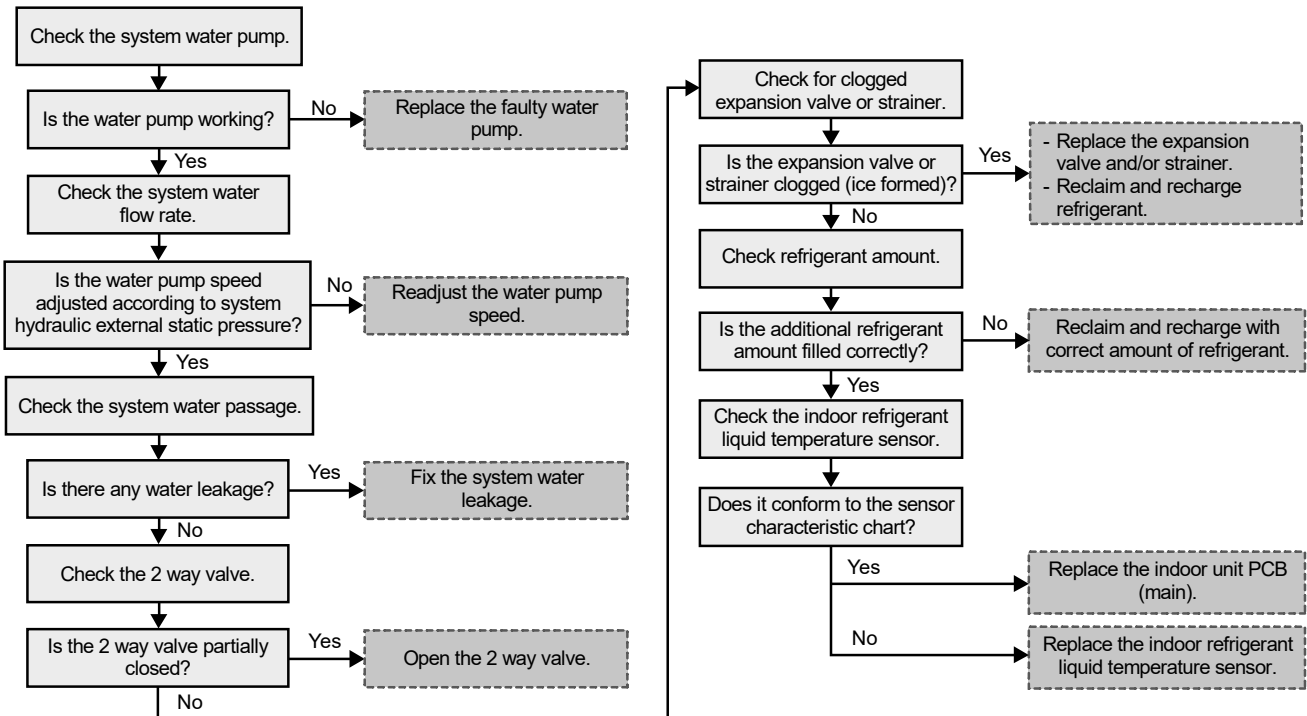

16.5.20 Outdoor High Pressure Switch Activate (F12)

Malfunction Decision Conditions:

During operation of cooling and heating, when pressure 4.5 MPa and above is detected by outdoor high pressure switch.

Malfunction Caused:

- 1 Dust accumulation on the outdoor unit heat exchanger.
- 2 Air short circuit at outdoor unit.
- 3 Faulty water pump.
- 4 Insufficient water flow rate in system.
- 5 Water leak in system.
- 6 2/3 way valve closed.
- 7 Clogged expansion valve or strainer.
- 8 Excessive refrigerant.
- 9 Faulty outdoor high pressure sensor and switch.
- 10 Faulty outdoor unit PCB.

Abnormality Judgment:

Continue 4 times in 20 minutes.

Troubleshooting:



Caution

For safety reason and to prevent component breakdown, always switch off the power before remove and connect the component.

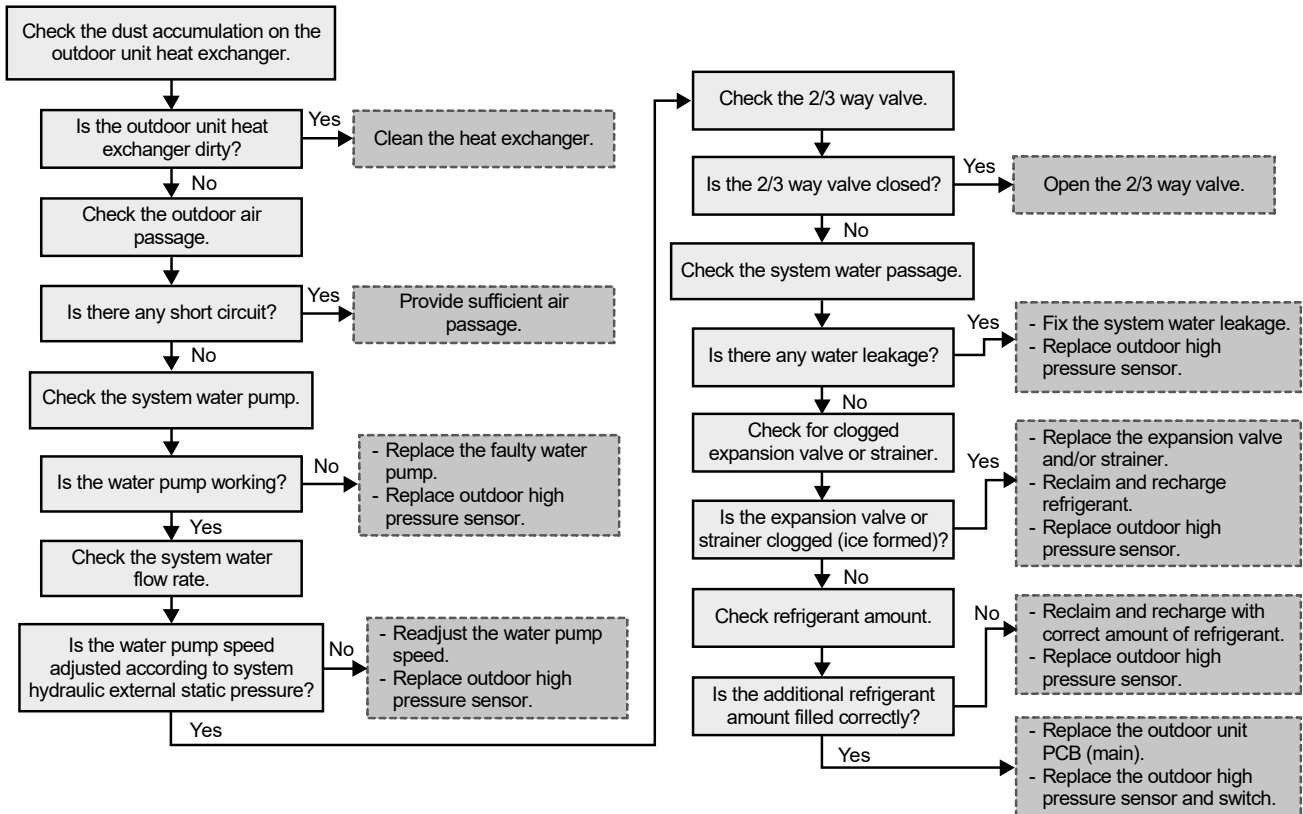

16.5.21 Compressor Rotation Failure (F14)

Malfunction Decision Conditions:

A compressor rotation failure is detected by checking the compressor running condition through the position detection circuit.

Malfunction Caused:

- 1 Compressor terminal disconnect.
- 2 Faulty outdoor unit PCB (main).
- 3 Faulty compressor.

Abnormality Judgment:

Continue 4 times in 20 minutes.

Troubleshooting:



Caution

For safety reason and to prevent component breakdown, always switch off the power before remove and connect the component.

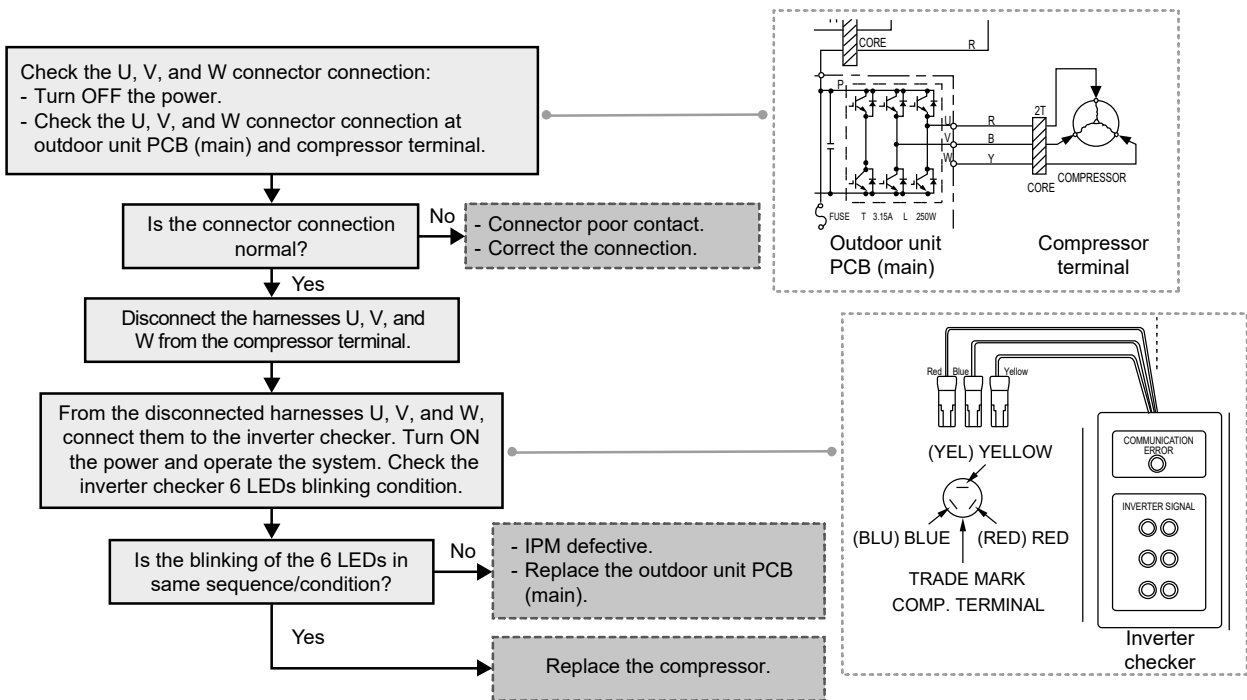

16.5.22 Outdoor Fan Motor (DC Motor) Mechanism Locked (F15)

Malfunction Decision Conditions:

The rotation speed detected by the Hall IC of the fan motor during fan motor operation is used to determine abnormal fan motor (feedback of rotation > 2550 rpm or < 50 rpm).

Malfunction Caused:

- 1 Operation stop due to short circuit inside the fan motor winding.
- 2 Operation stop due to breaking of wire inside the fan motor.
- 3 Operation stop due to breaking of fan motor lead wires.
- 4 Operation stop due to fan motor Hall IC malfunction.
- 5 Operation error due to faulty outdoor unit PCB.

Abnormality Judgment:

Continue 2 times in 30 minutes.

Troubleshooting:



Caution

For safety reason and to prevent component breakdown, always switch off the power before remove and connect the component.

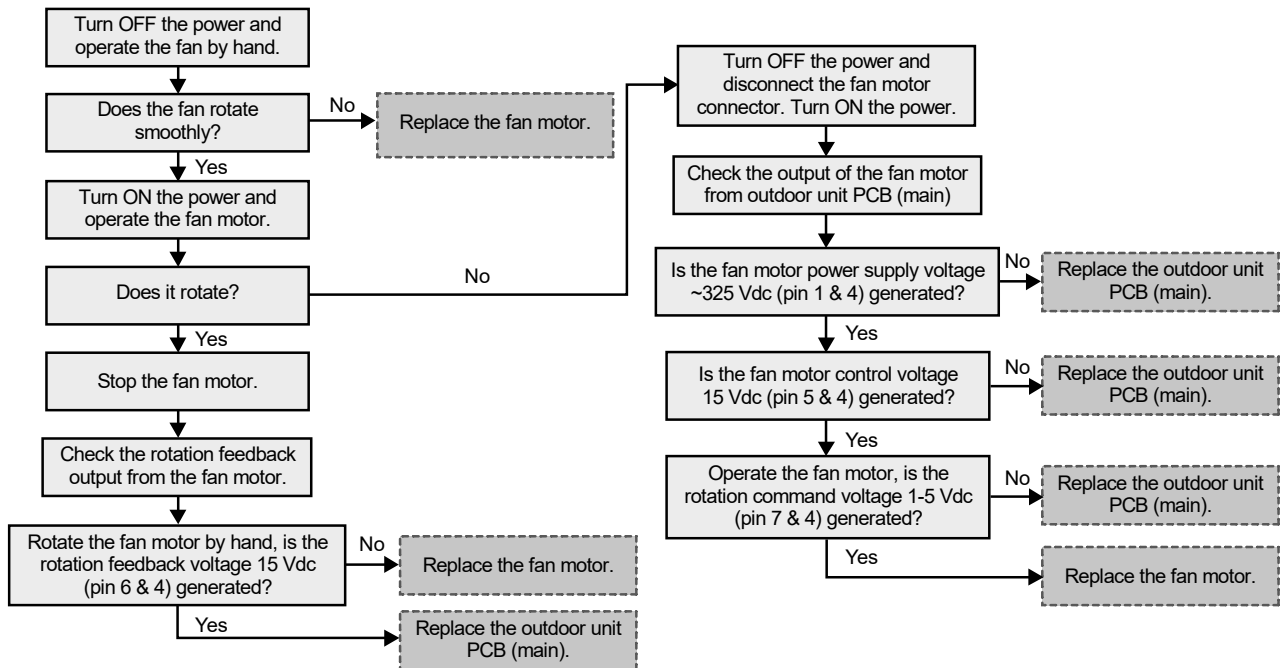

16.5.23 Input Over Current Detection (F16)

Malfunction Decision Conditions:

During operation of cooling and heating, when outdoor current above 14.8 A (UD03EE5, UD05EE5), 27.9 A (UD07FE5, UD09FE5) is detected by the current transformer (CT) in the outdoor unit PCB.

Malfunction Caused:

- 1 Excessive refrigerant.
- 2 Faulty outdoor unit PCB (main).

Abnormality Judgment:

Continue 3 times in 20 minutes.

Troubleshooting:



For safety reason and to prevent component breakdown, always switch off the power before remove and connect the component.

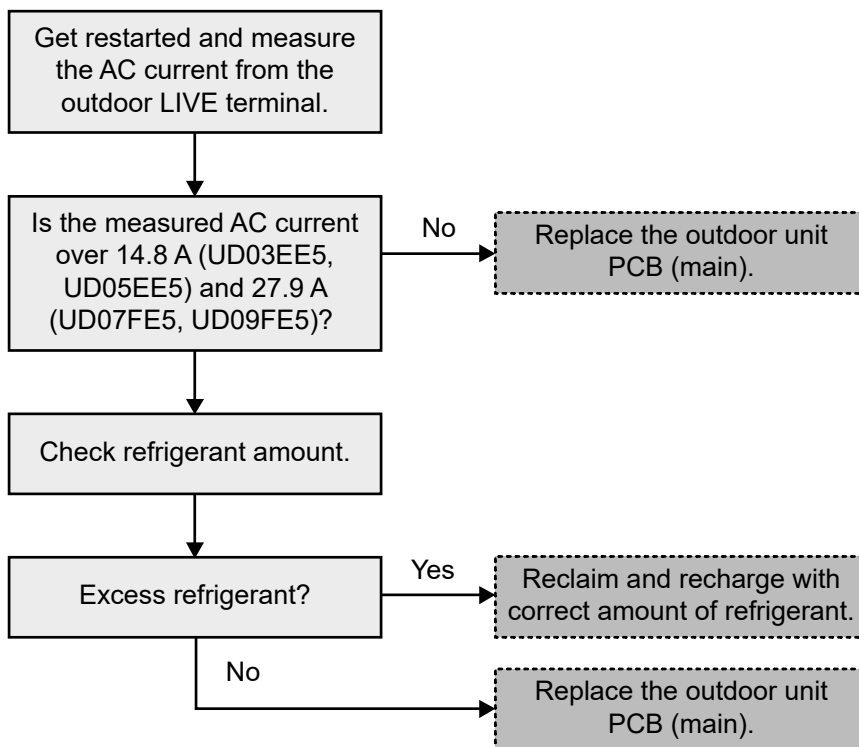

16.5.24 Compressor Overheating (F20)

Malfunction Decision Conditions:

During operation of cooling and heating, when temperature above 107°C (UD03EE5, UD05EE5), 112°C (UD07FE5, UD09FE5) is detected by the compressor tank temperature sensor.

Malfunction Caused:

- 1 Faulty compressor tank temperature sensor.
- 2 2/3 way valve closed.
- 3 Refrigerant shortage (refrigerant leakage).
- 4 Clogged expansion valve or strainer.
- 5 Faulty outdoor unit PCB (main).
- 6 Faulty compressor.

Abnormality Judgment:

Continue 4 times in 30 minutes.

Troubleshooting:



Caution

For safety reason and to prevent component breakdown, always switch off the power before remove and connect the component.

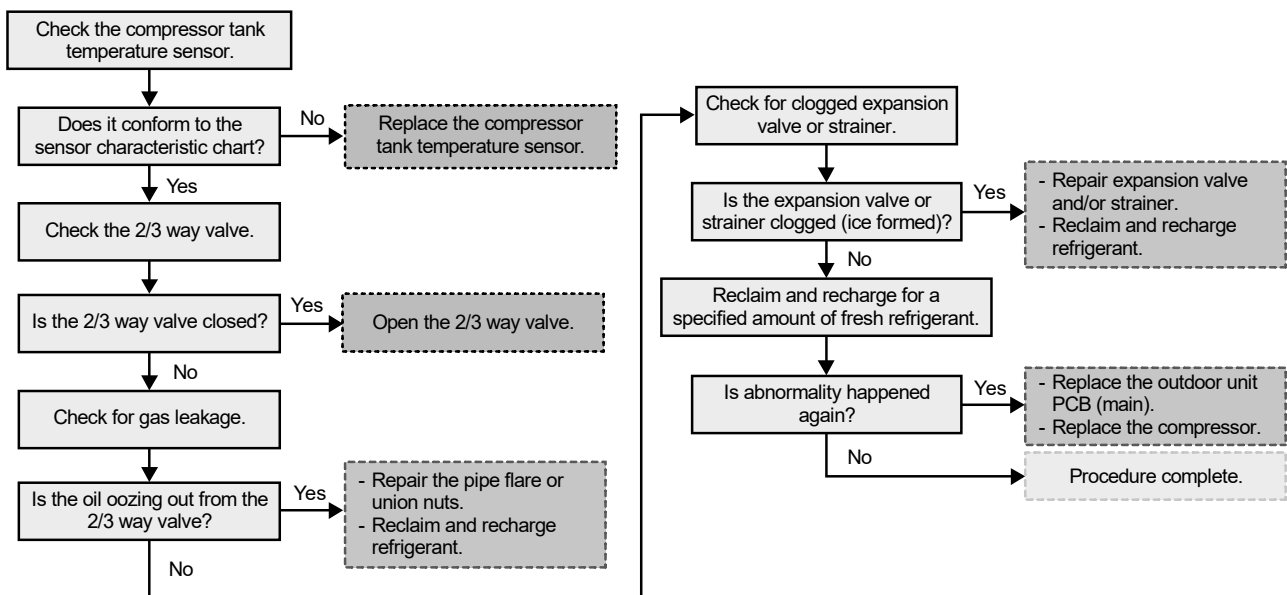

16.5.25 IPM Overheating (F22)

Malfunction Decision Conditions:

During operation of cooling and heating, when temperature 95°C is detected by the outdoor IPM temperature sensor.

Malfunction Caused:

- 1 Faulty outdoor unit fan motor.
- 2 Faulty outdoor unit PCB (main).

Abnormality Judgment:

Continue 3 times in 30 minutes.

Troubleshooting:



Caution

For safety reason and to prevent component breakdown, always switch off the power before remove and connect the component.

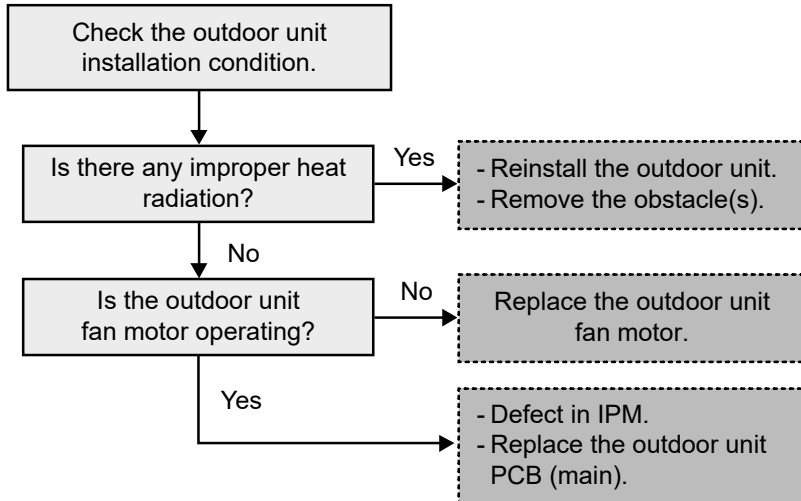

16.5.26 Output Over Current Detection (F23)

Malfunction Decision Conditions:

During operation of cooling and heating, when outdoor DC current is above 21.1 A (UD03EE5, UD05EE5) 50.0 A (UD07FE5, UD09FE5) is detected by the IPM DC Peak sensing circuitry in the outdoor unit PCB (main).

Malfunction Caused:

- 1 Faulty outdoor unit PCB (main).
- 2 Faulty compressor.

Abnormality Judgment:

Continue for 7 times.

Troubleshooting:



For safety reason and to prevent component breakdown, always switch off the power before remove and connect the component.

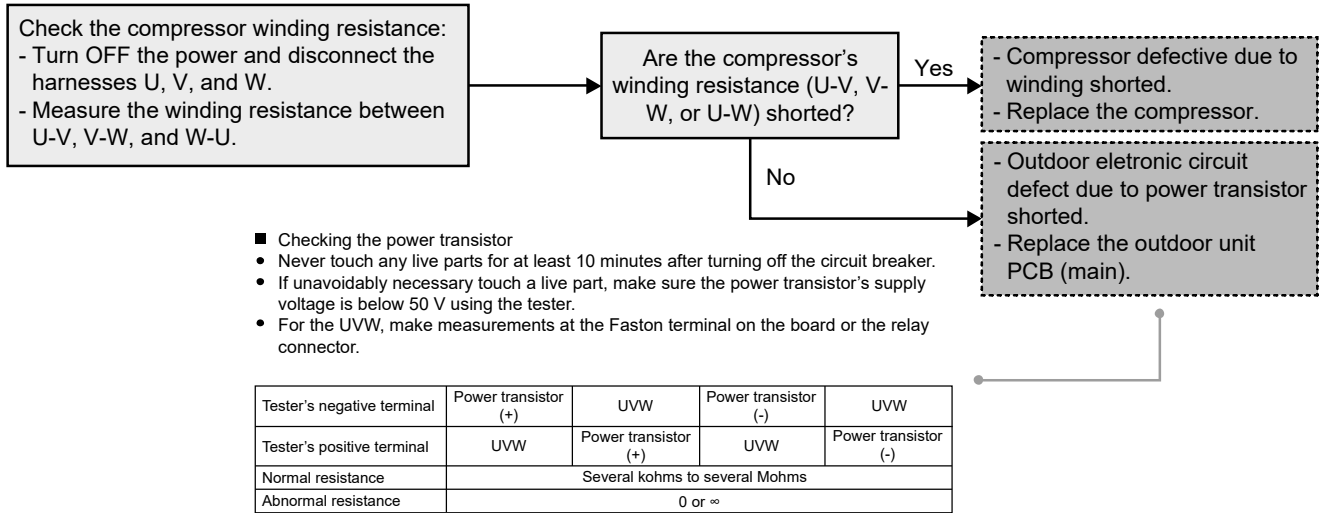

16.5.27 Refrigeration Cycle Abnormality (F24) (WH-UD03EE5 and WH-UD05EE5)

Malfunction Decision Conditions:

- 1 During operation of cooling and heating, compressor frequency > Frated.
- 2 During operation of cooling and heating, running current: $0.65 \text{ A} < I < 1.65 \text{ A}$.
- 3 During operation of cooling, water inlet temperature - indoor refrigerant liquid temperature < 4°C .
- 4 During operation of heating, indoor refrigerant liquid temperature - water inlet temperature < 5°C .

Malfunction Caused:

- 1 Faulty water inlet or indoor refrigerant liquid temperature sensors.
- 2 2/3 way valve closed.
- 3 Refrigerant shortage (refrigerant leakage).
- 4 Clogged expansion valve or strainer.
- 5 Faulty outdoor unit PCB (main).
- 6 Poor compression of compressor.

Abnormality Judgment:

Continue 2 times in 20 minutes.

Troubleshooting:



Caution

For safety reason and to prevent component breakdown, always switch off the power before remove and connect the component.

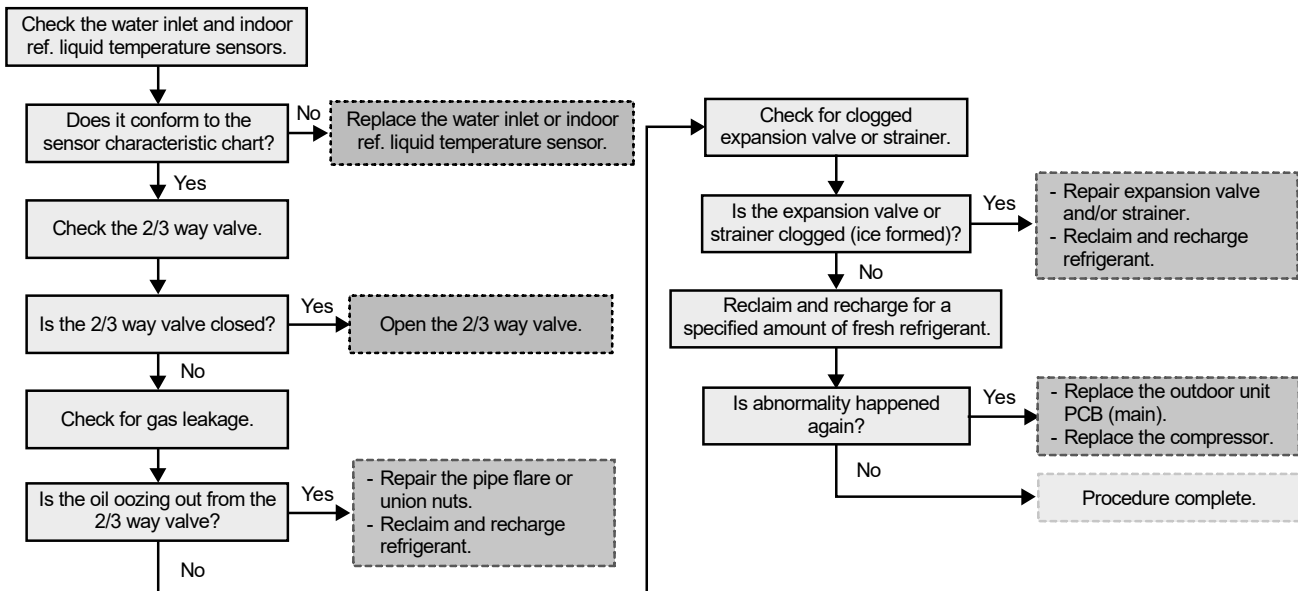

16.5.28 Refrigeration Cycle Abnormality (F24) (WH-UD07FE5 and WH-UD09FE5)

Malfunction Decision Conditions:

- 1 During compressor running (heating / cooling) for more than 10 minutes except deice, pumpdown and test mode.
- 2 During heating / cooling, water outlet and water inlet difference is less than 1°C.
- 3 During heating / cooling, high pressure < 1MPa (143 Psi) for more than 10 minutes or < 0.2 MPa (28 Psi) for more than 5 minutes.
- 4 During heating / cooling, discharge temperature - saturation temperature of high pressure $\geq 60^{\circ}\text{C}$.

Malfunction Caused:

- 1 Refrigerant shortage (refrigerant leakage).
- 2 Faulty indoor water inlet, indoor water outlet, compressor discharge temp sensor or high pressure sensor.
- 3 2/3 way valve closed.
- 4 Clogged expansion valve or strainer.
- 5 Faulty indoor or outdoor PCB (main).

Abnormality Judgment:

Continue 2 times in 30 minutes.

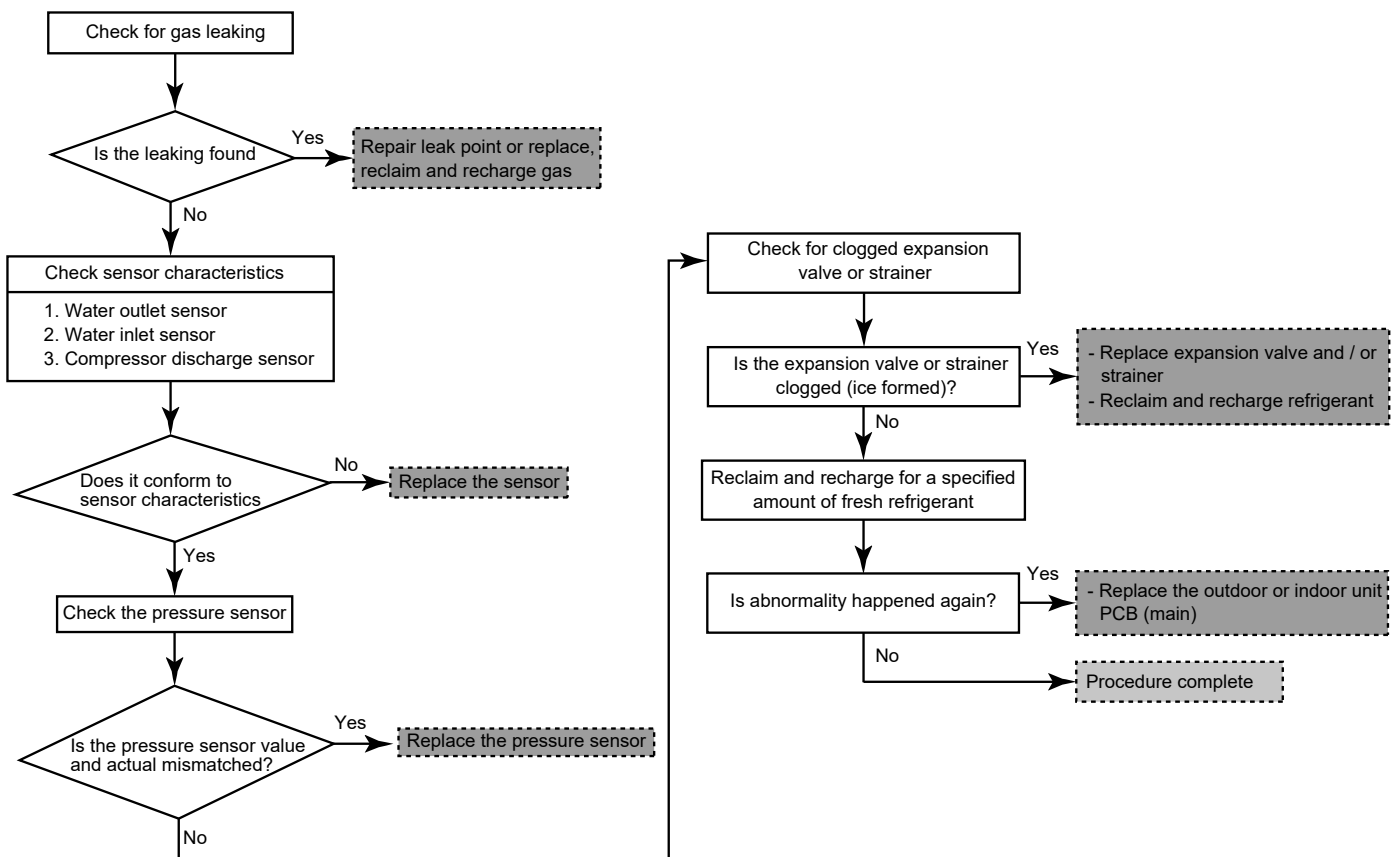

16.5.29 Four Way Valve Abnormality (F25)

Malfunction Decision Conditions:

- 1 During heating operation, when the indoor pipe temperature of thermostat ON indoor unit < 0°C.
- 2 During cooling operation, when the indoor pipe temperature of thermostat ON indoor unit > 45°C.

Malfunction Caused:

- 1 Faulty sensor.
- 2 Faulty connector connection.
- 3 Faulty outdoor unit PCB (noise filter/main).
- 4 Faulty four way valve.

Abnormality Judgment:

Continue 4 times in 30 minutes.

Troubleshooting:



Caution

For safety reason and to prevent component breakdown, always switch off the power before remove and connect the component.

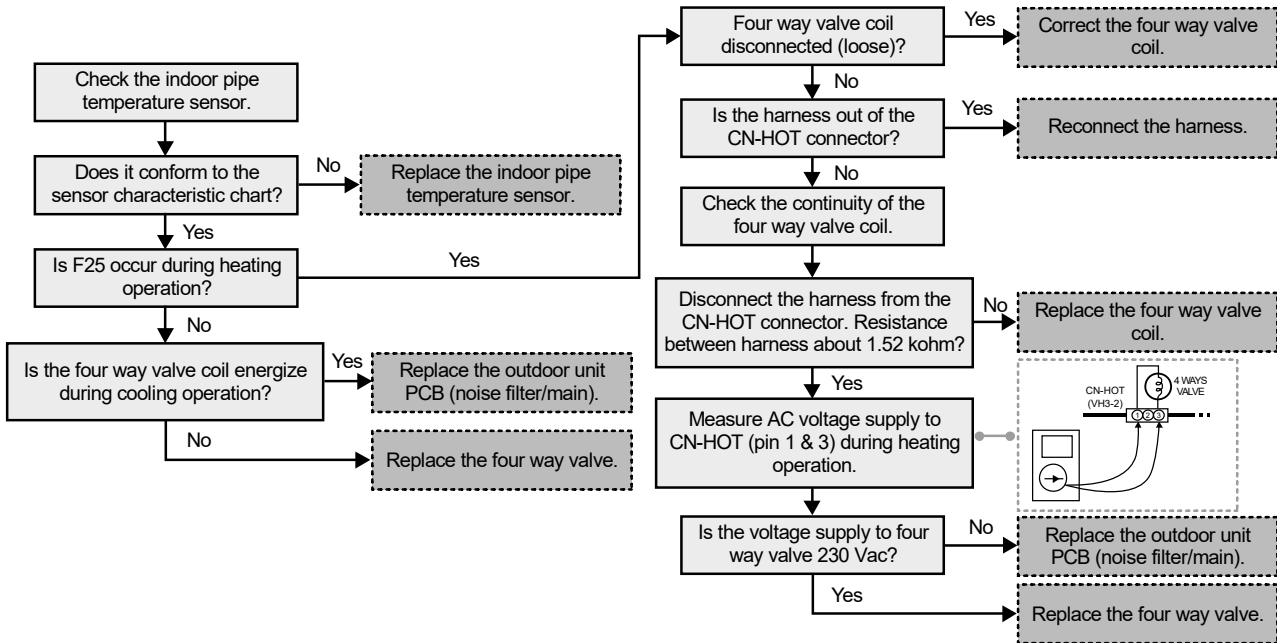

16.5.30 Outdoor High Pressure Switch Abnormal (F27)

Malfunction Decision Conditions:

During compressor stop, and outdoor high pressure switch is remain opened.

Malfunction Caused:

- 1 Faulty connector connection.
- 2 Faulty switch.
- 3 Faulty outdoor unit PCB (main).

Abnormality Judgment:

Continue for 1 minute.

Troubleshooting:



For safety reason and to prevent component breakdown, always switch off the power before remove and connect the component.

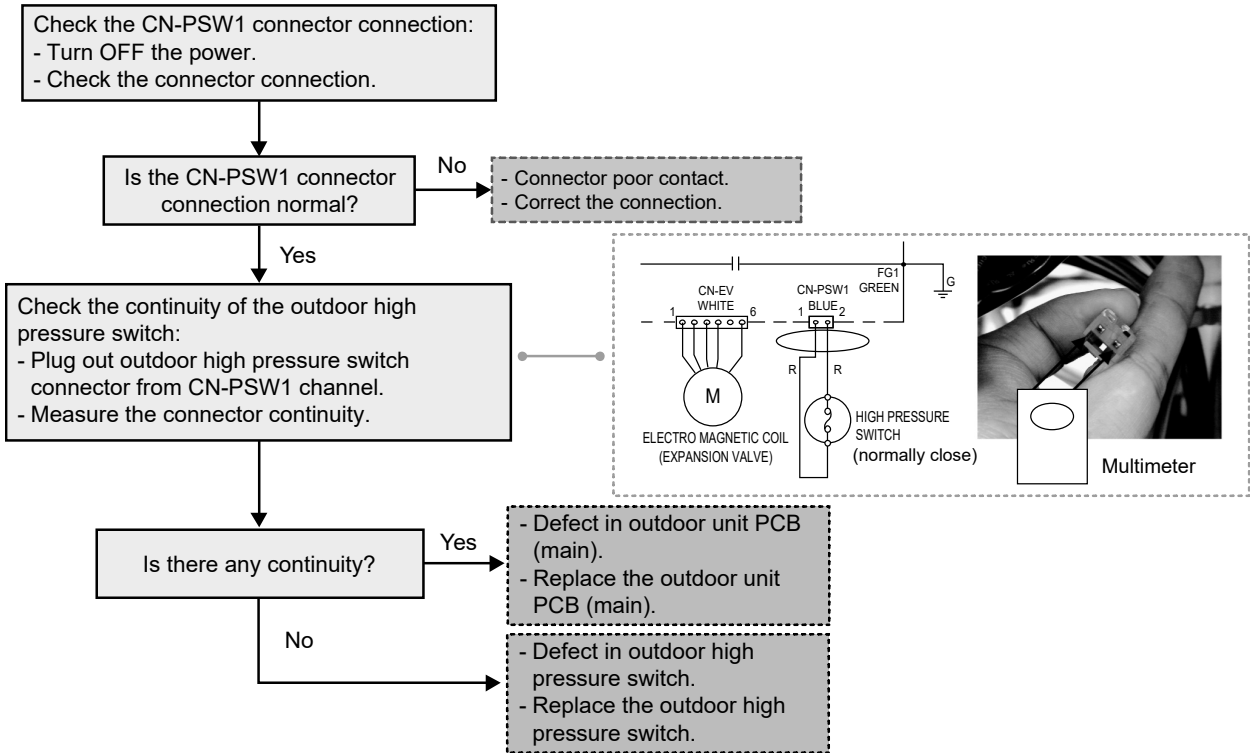

16.5.31 Indoor Water Outlet Temperature Sensor 2 Abnormality (F30)

Malfunction Decision Conditions:

During startup and operation of cooling and heating, the temperatures detected by the indoor water outlet temperature sensor 2 are used to determine sensor error.

Malfunction Caused:

- 1 Faulty connector connection.
- 2 Faulty sensor.
- 3 Faulty indoor unit PCB.

Abnormality Judgment:

Continue for 5 seconds.

Troubleshooting:



Caution

For safety reason and to prevent component breakdown, always switch off the power before remove and connect the component.

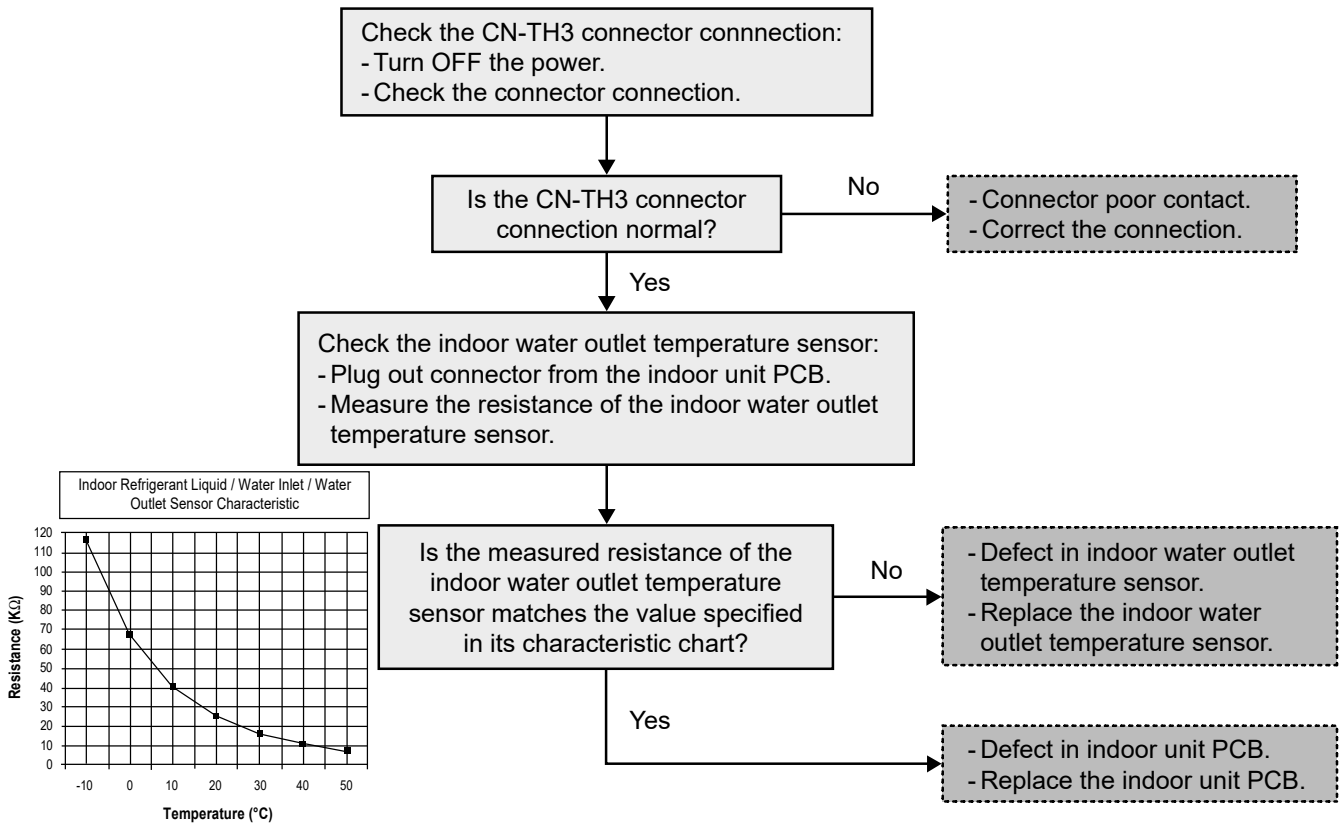

16.5.32 Outdoor Air Temperature Sensor Abnormality (F36)

Malfunction Decision Conditions:

During startup and operation of cooling and heating, the temperatures detected by the outdoor air temperature sensor are used to determine sensor error.

Malfunction Caused:

- 1 Faulty connector connection.
- 2 Faulty sensor.
- 3 Faulty outdoor unit PCB (main).

Abnormality Judgment:

Continue for 5 seconds.

Troubleshooting:



Caution

For safety reason and to prevent component breakdown, always switch off the power before remove and connect the component.

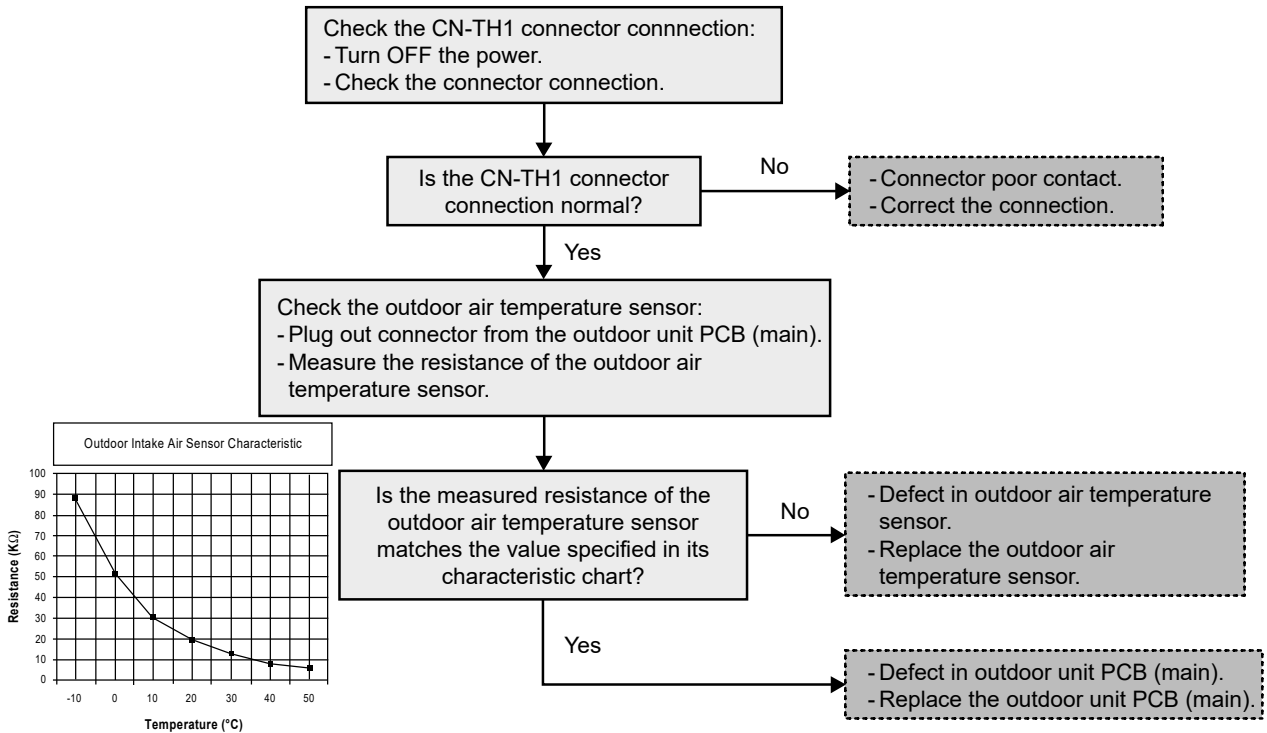

16.5.33 Indoor Water Inlet Temperature Sensor Abnormality (F37)

Malfunction Decision Conditions:

During startup and operation of cooling and heating, the temperatures detected by the indoor water inlet temperature sensor are used to determine sensor error.

Malfunction Caused:

- 1 Faulty connector connection.
- 2 Faulty sensor.
- 3 Faulty indoor unit PCB (main).

Abnormality Judgment:

Continue for 5 seconds.

Troubleshooting:



Caution

For safety reason and to prevent component breakdown, always switch off the power before remove and connect the component.

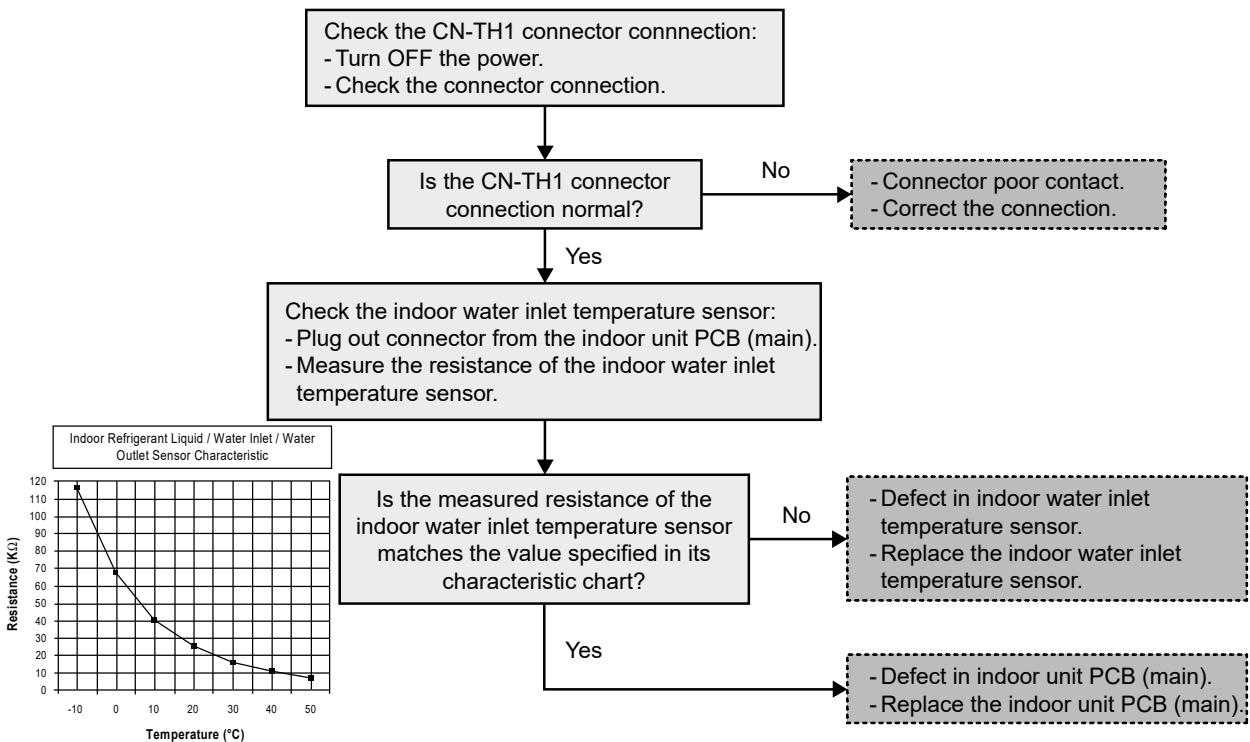

16.5.34 Outdoor Discharge Pipe Temperature Sensor Abnormality (F40)

Malfunction Decision Conditions:

During startup and operation of cooling and heating, the temperatures detected by the outdoor discharge pipe temperature sensor are used to determine sensor error.

Malfunction Caused:

- 1 Faulty connector connection.
- 2 Faulty sensor.
- 3 Faulty outdoor unit PCB (main).

Abnormality Judgment:

Continue for 5 seconds.

Troubleshooting:



Caution

For safety reason and to prevent component breakdown, always switch off the power before remove and connect the component.

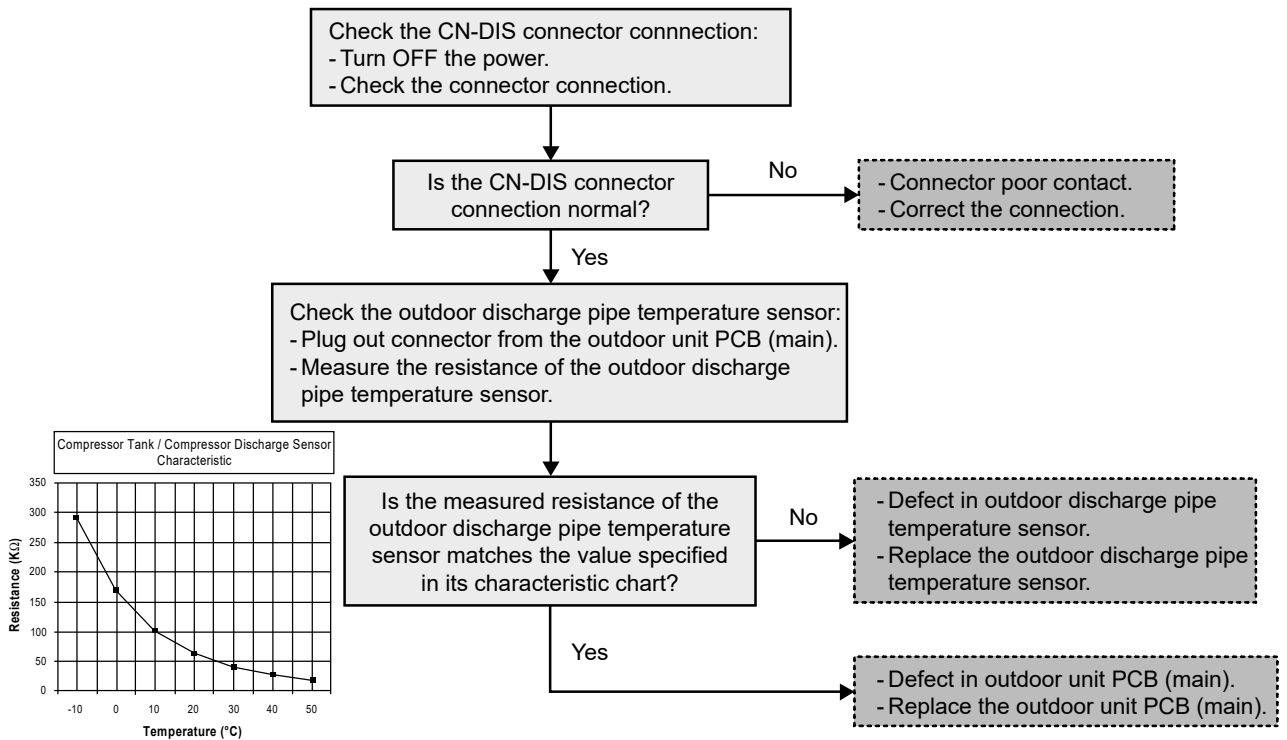

16.5.35 Power Factor Correction (PFC) Abnormality (F41)

Malfunction Decision Conditions:

During operation of cooling and heating, when the PFC protection circuitry in the outdoor unit PCB (main) senses abnormal high DC voltage level.

Malfunction Caused:

- 1 Power supply surge.
- 2 Compressor windings not uniform.
- 3 Faulty outdoor unit PCB (main).

Abnormality Judgment:

Continue 4 times in 10 minutes.

Troubleshooting:



Caution

For safety reason and to prevent component breakdown, always switch off the power before remove and connect the component.

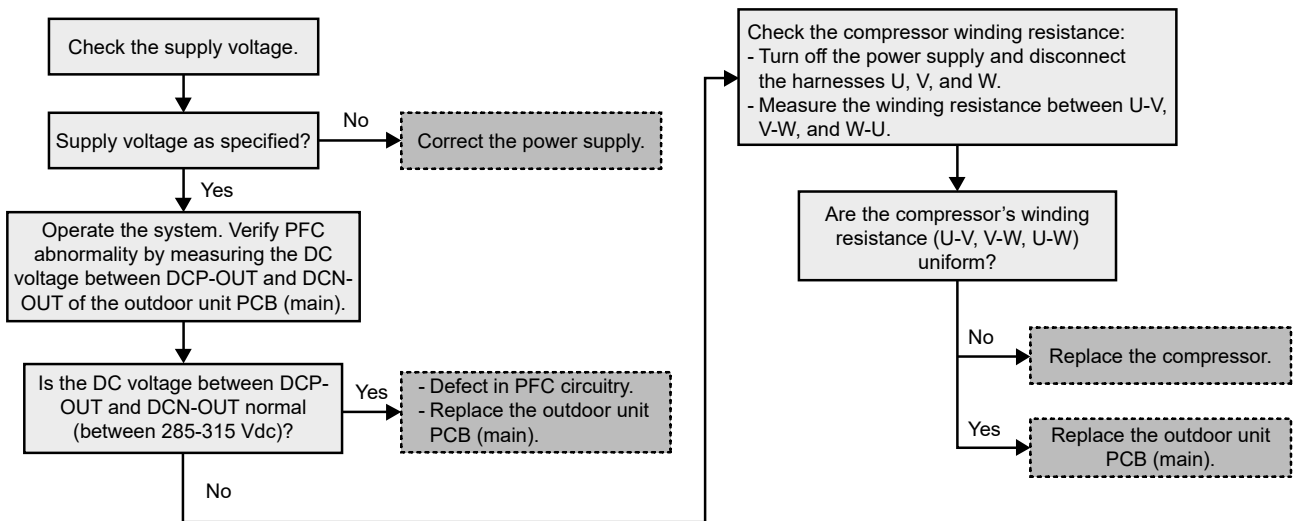

16.5.36 Outdoor Pipe Temperature Sensor Abnormality (F42)

Malfunction Decision Conditions:

During startup and operation of cooling and heating, the temperatures detected by the outdoor pipe temperature sensor are used to determine sensor error.

Malfunction Caused:

- 1 Faulty connector connection.
- 2 Faulty sensor.
- 3 Faulty outdoor unit PCB (main).

Abnormality Judgment:

Continue for 5 seconds.

Troubleshooting:



Caution

For safety reason and to prevent component breakdown, always switch off the power before remove and connect the component.

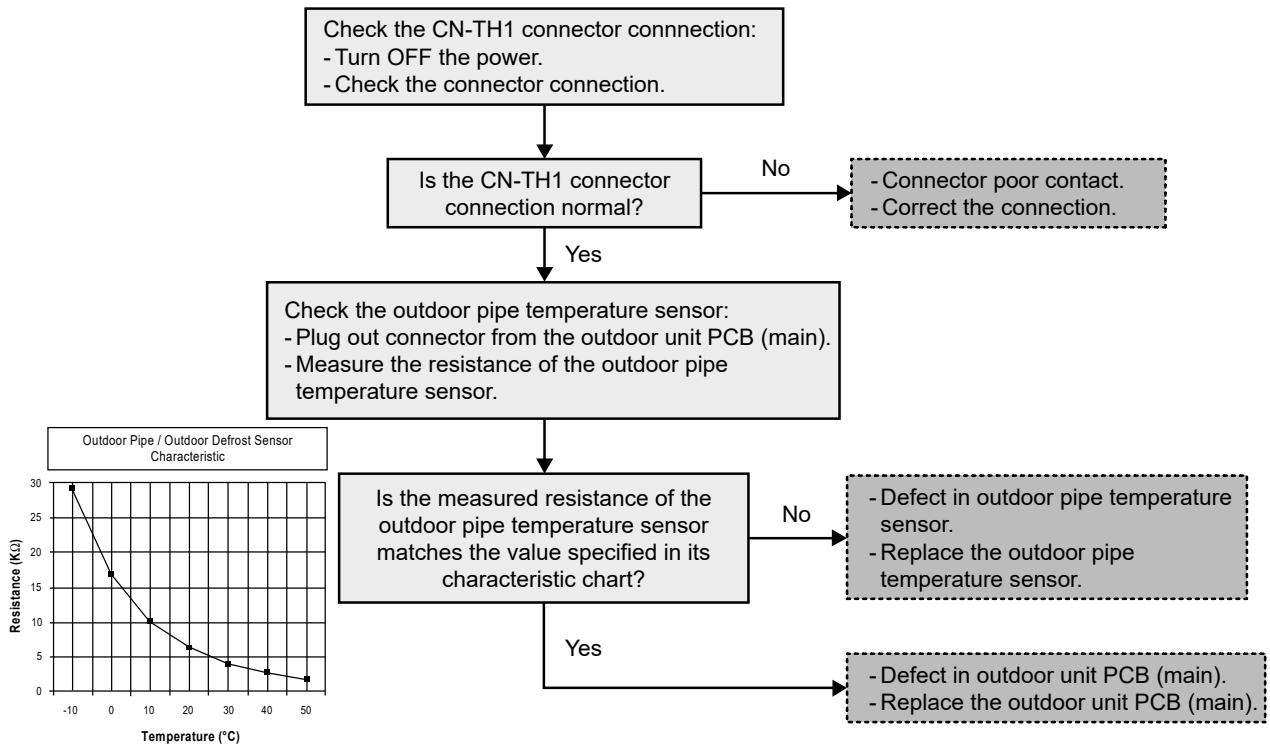

16.5.37 Outdoor Defrost Temperature Sensor Abnormality (F43)

Malfunction Decision Conditions:

During startup and operation of cooling and heating, the temperatures detected by the outdoor defrost temperature sensor are used to determine sensor error.

Malfunction Caused:

- 1 Faulty connector connection.
- 2 Faulty sensor.
- 3 Faulty outdoor unit PCB (main).

Abnormality Judgment:

Continue for 5 seconds.

Troubleshooting:



For safety reason and to prevent component breakdown, always switch off the power before remove and connect the component.

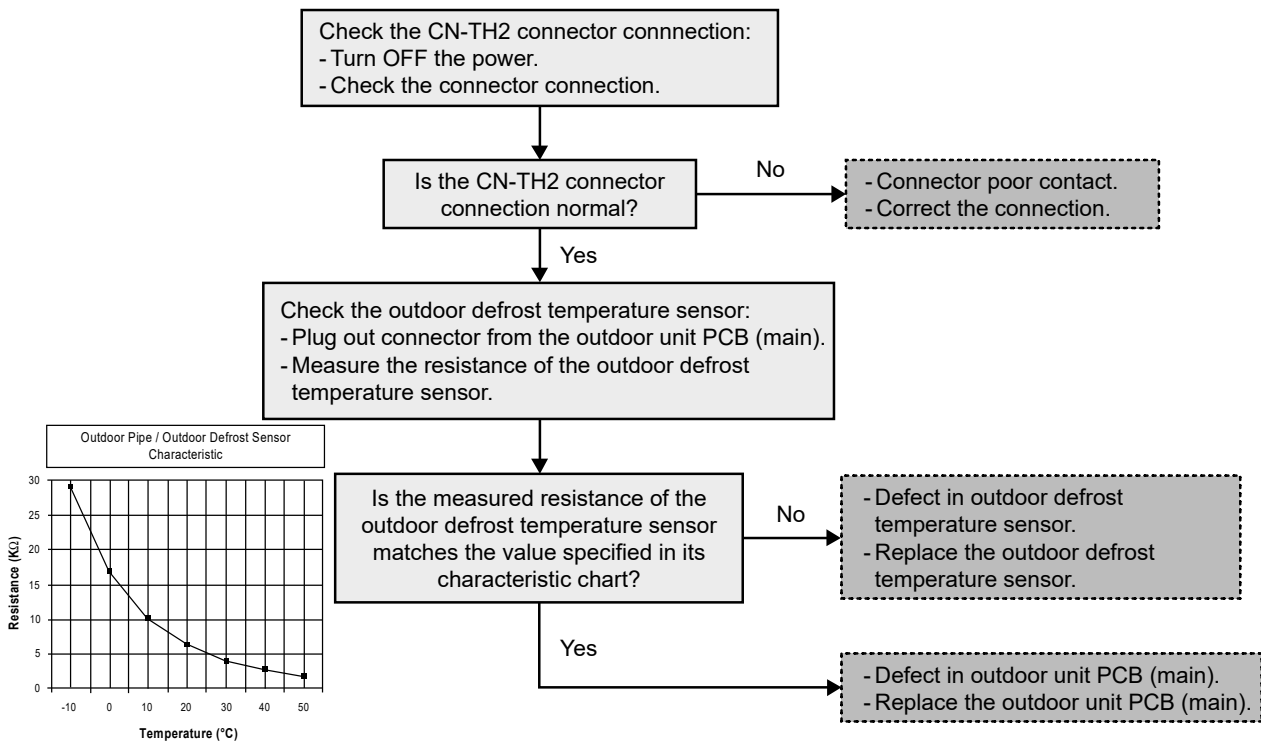

16.5.38 Indoor Water Outlet Temperature Sensor Abnormality (F45)

Malfunction Decision Conditions:

During startup and operation of cooling and heating, the temperatures detected by the indoor water outlet temperature sensor are used to determine sensor errors.

Malfunction Caused:

- 1 Faulty connector connection.
- 2 Faulty sensor.
- 3 Faulty indoor unit PCB (main).

Abnormality Judgment:

Continue for 5 seconds.

Troubleshooting:



Caution

For safety reason and to prevent component breakdown, always switch off the power before remove and connect the component.

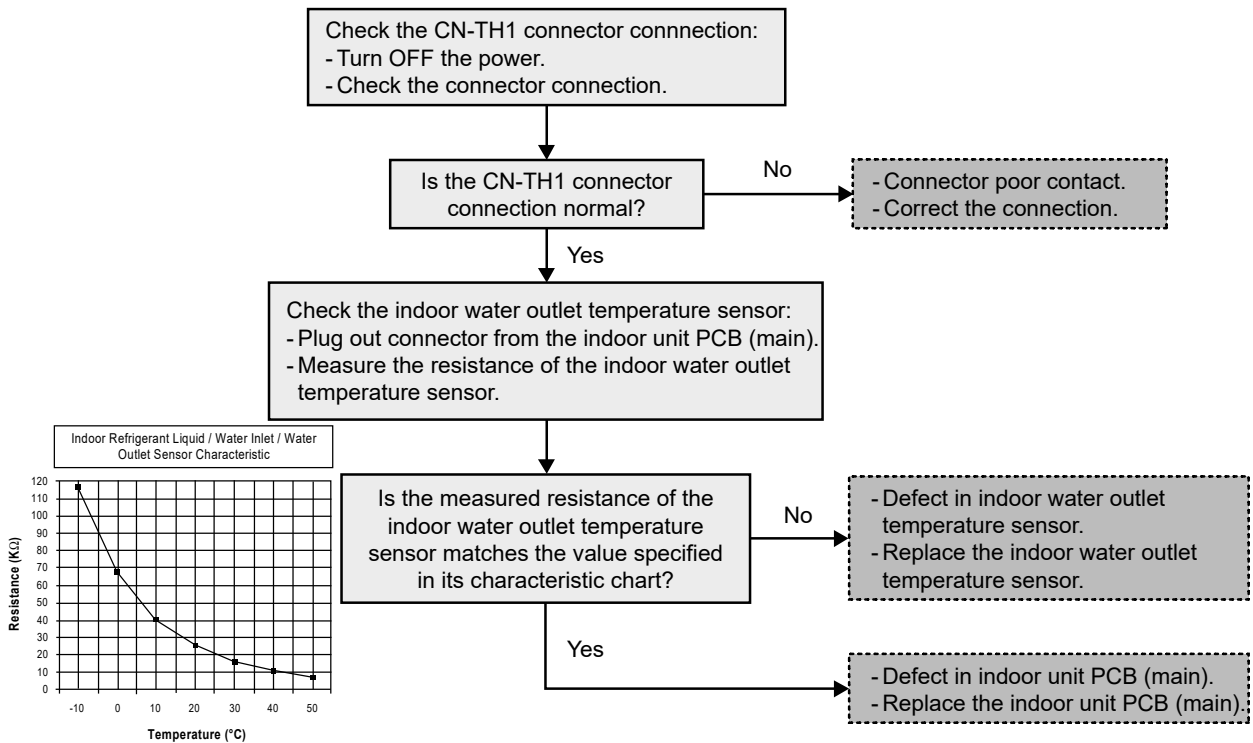

16.5.39 Outdoor Current Transformer Open Circuit (F46)

Malfunction Decision Conditions:

A current transformer (CT) open circuit is detected by checking the compressor running frequency (\geq rated frequency) and CT detected input current (< 0.65 A) for continuously 20 seconds.

Malfunction Caused:

- 1 CT defective.
- 2 Faulty outdoor unit PCB (main).
- 3 Compressor defective (low compression).

Abnormality Judgment:

Continue 3 times in 20 minutes.

Troubleshooting:



Caution

For safety reason and to prevent component breakdown, always switch off the power before remove and connect the component.

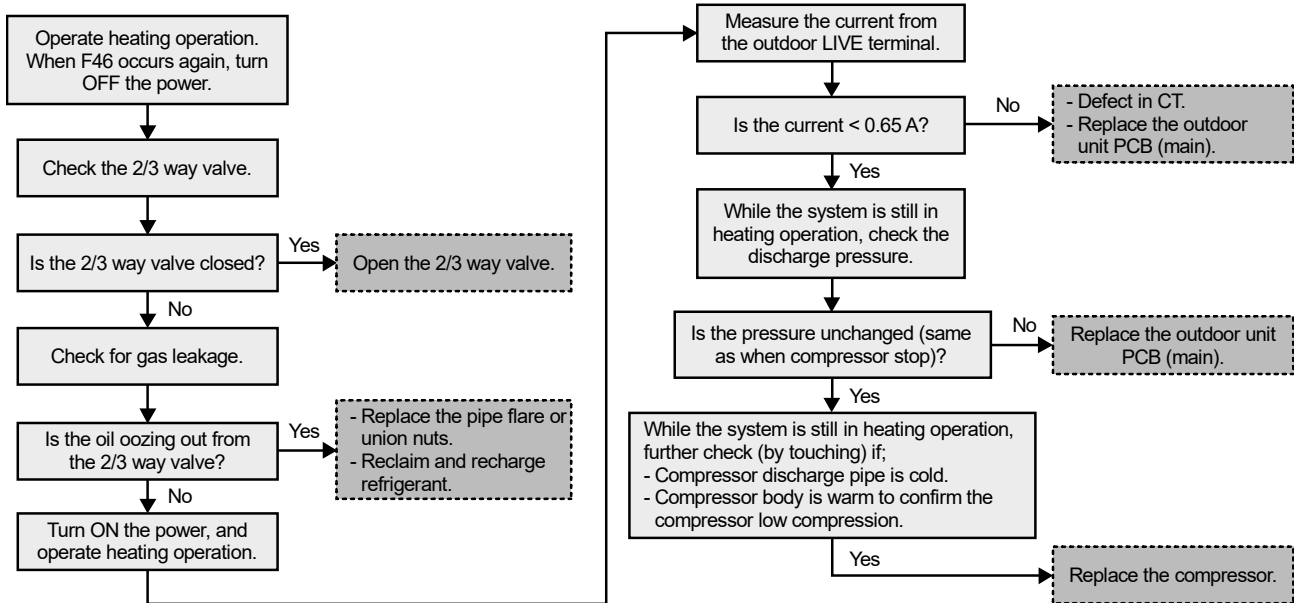

16.5.40 Cooling High Pressure Overload Protection (F95)

Malfunction Decision Conditions:

During operation of cooling, when pressure 4.0 MPa and above is detected by outdoor high pressure sensor.

Malfunction Caused:

- 1 Dust accumulation in the outdoor unit heat exchanger.
- 2 Air short circuit at outdoor unit.
- 3 2 way valve closed.
- 4 Faulty outdoor unit fan motor.
- 5 Clogged expansion valve or strainer.
- 6 Excessive refrigerant.
- 7 Faulty outdoor high pressure sensor.
- 8 Faulty outdoor unit PCB (main).

Troubleshooting:



Caution

For safety reason and to prevent component breakdown, always switch off the power before remove and connect the component.

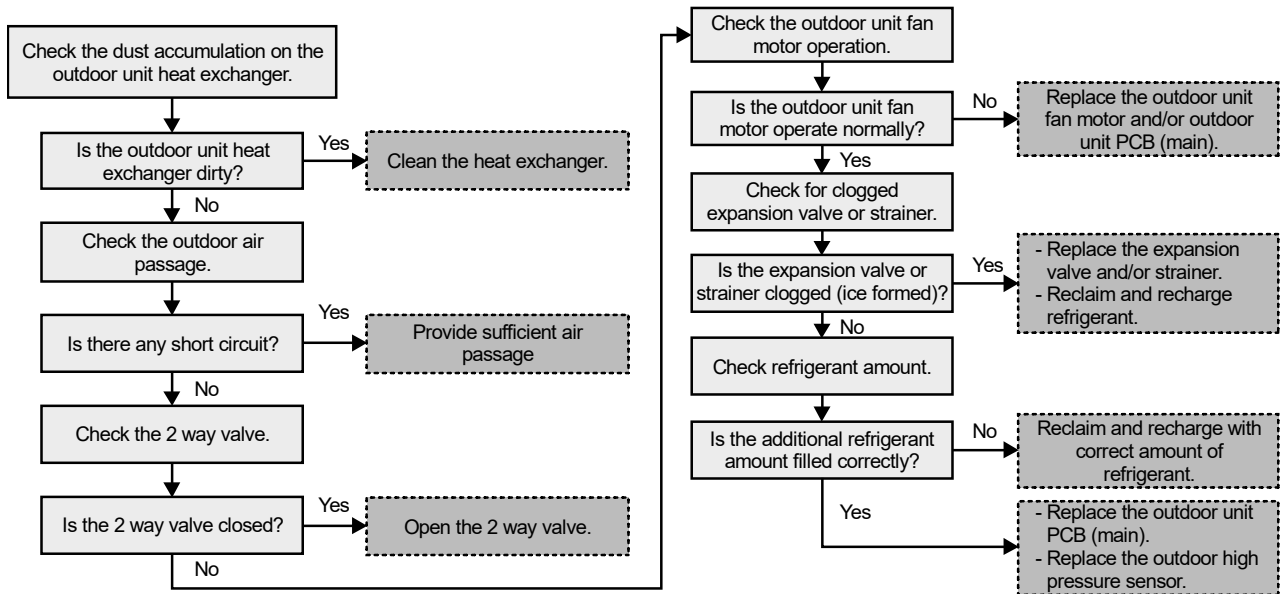

17. Disassembly and Assembly Instructions



High Voltage are generated in the electrical parts area by the capacitor. Ensure that the capacitor has discharged sufficiently before proceeding with repair work. Failure to heed this caution may result in electric shocks.

17.1 To Remove Top Plate

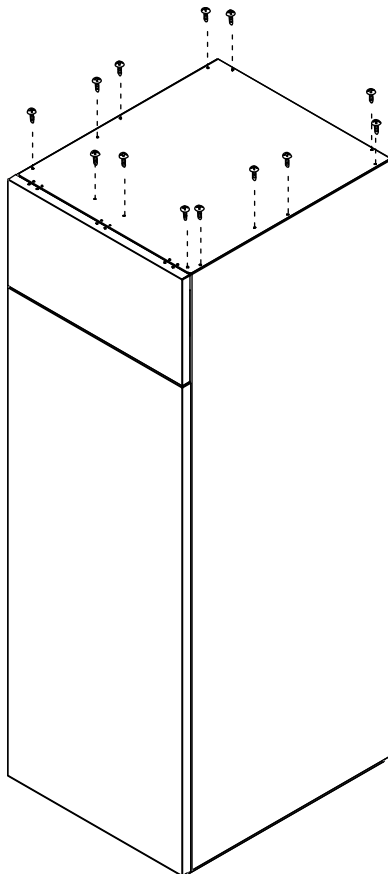

- 1 Remove 13 mounting screws from the Top Plate.

17.2 To Remove Pressure Gauge and Control Panel

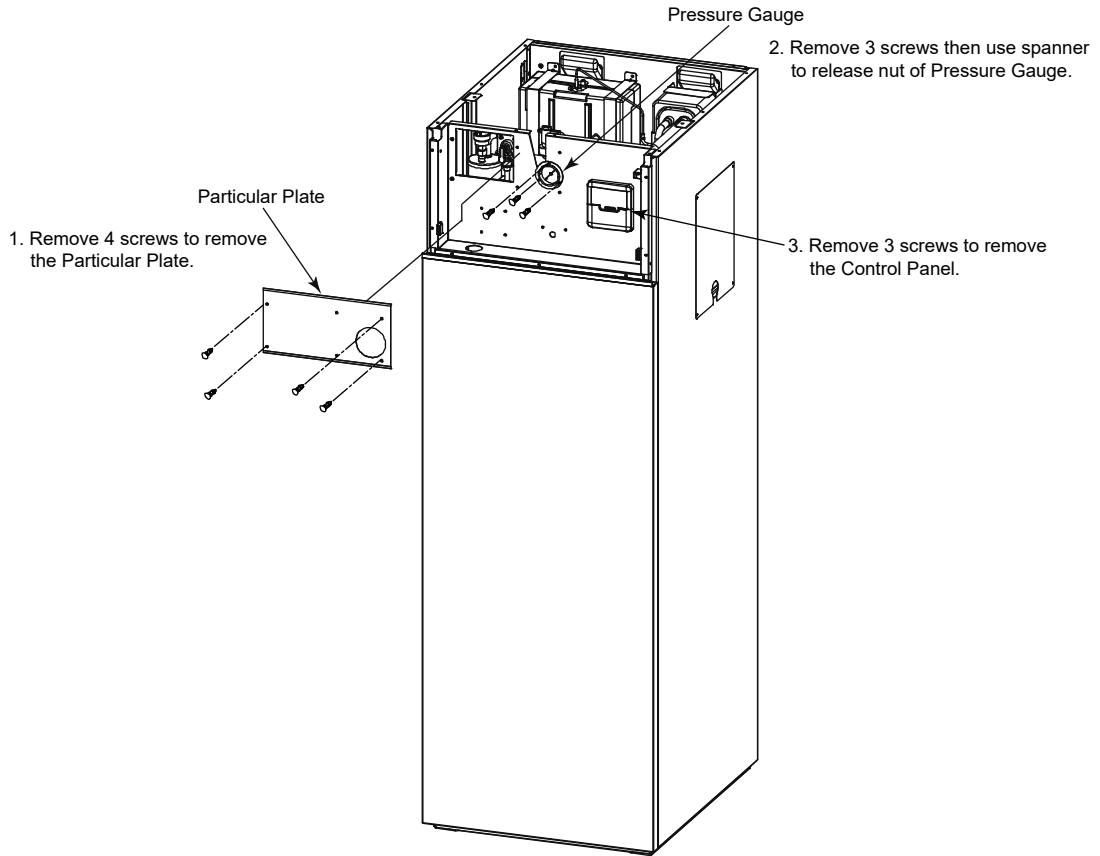

17.3 To Remove Bottom Front Plate

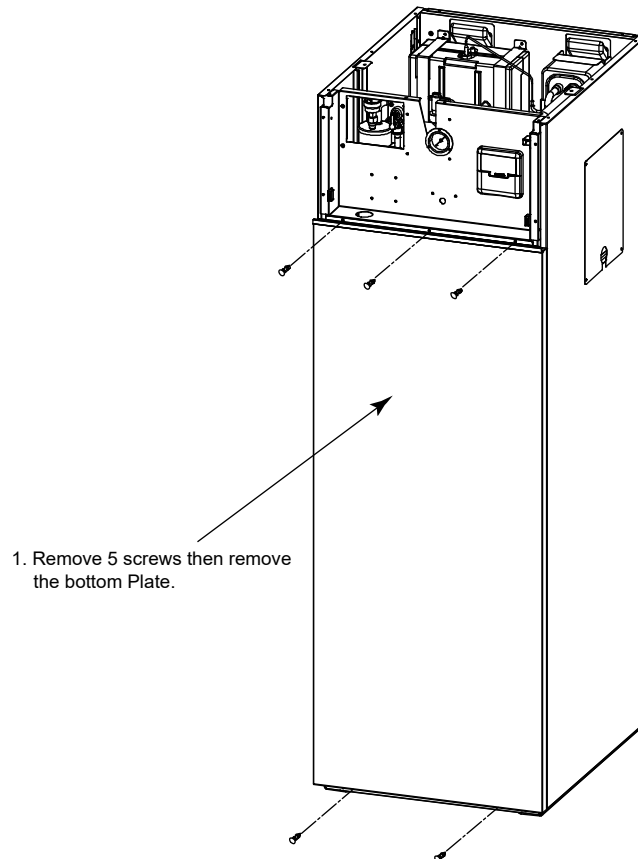

17.4 To Remove RCCB

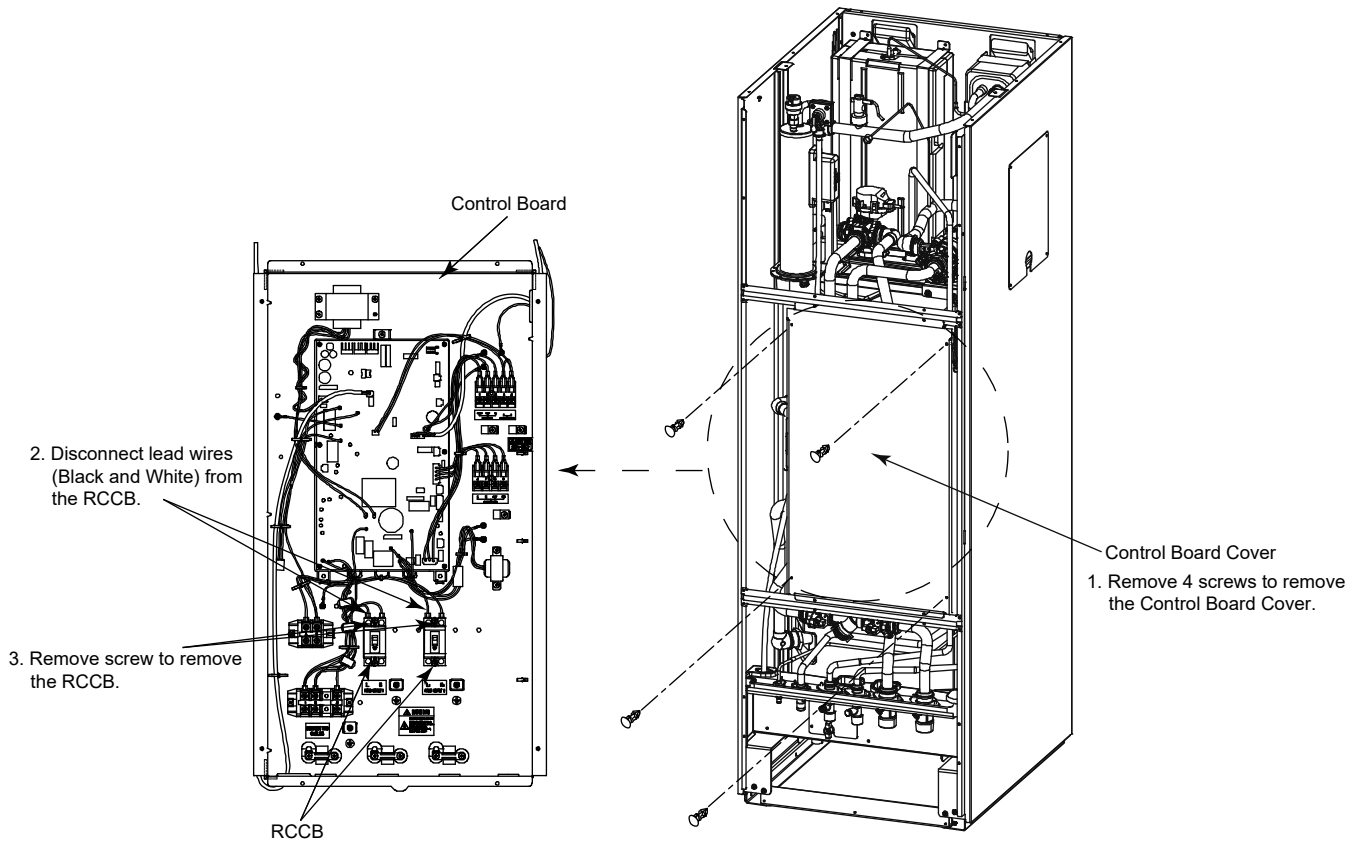

17.5 To Remove Transformer and Electronic Controller

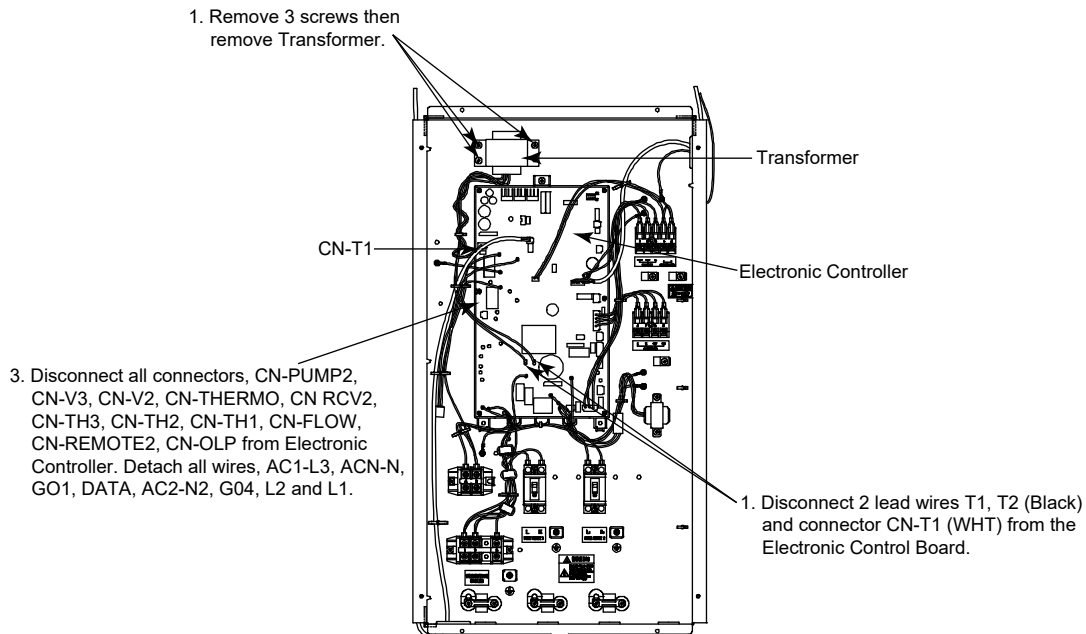

17.6 To Remove Pressure Relief Valve, Flow Switch and Air Purge Valve

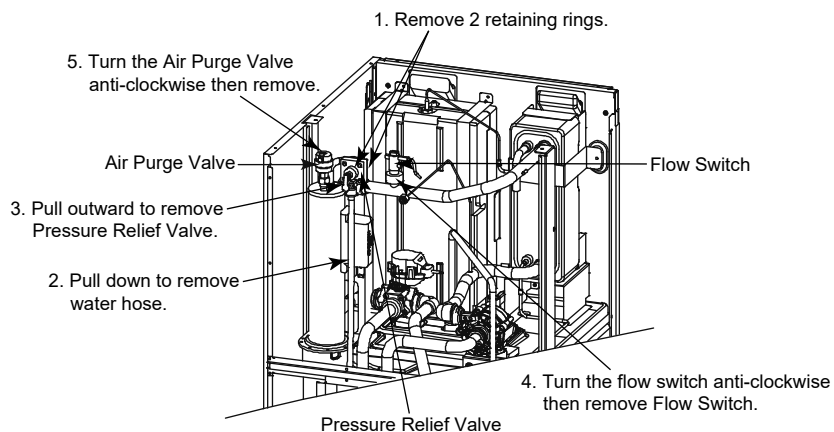

 When reinstall Flow Switch, ensure the arrow on the flow switch is parallel with the pipe shaft and is facing in the direction of flow.

 During reinstall Air Purge Valve.

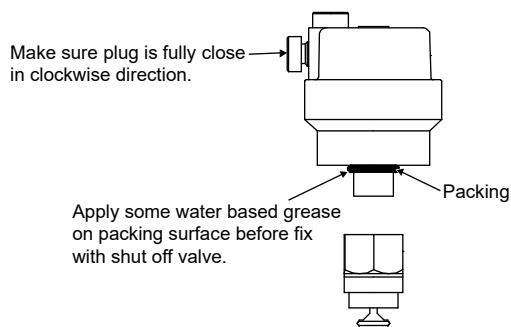

17.7 To Remove Water Pump

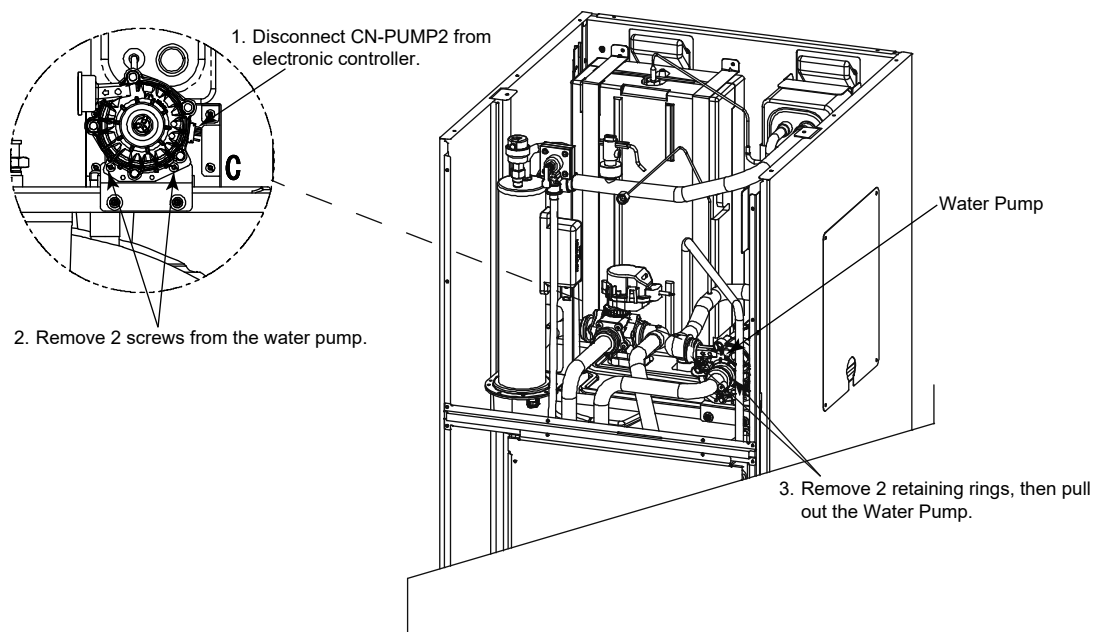

17.8 To Remove Bottle Complete

1. Disconnect the connector CN-OLP1 from the Electronic Controller and detached the lead wire HT1-L3 (Red) and AC2-L3 (Black).

2. Loosen 2 nuts.

3. Remove Air Purge Valve.

4. Remove Pressure Relief Valve.

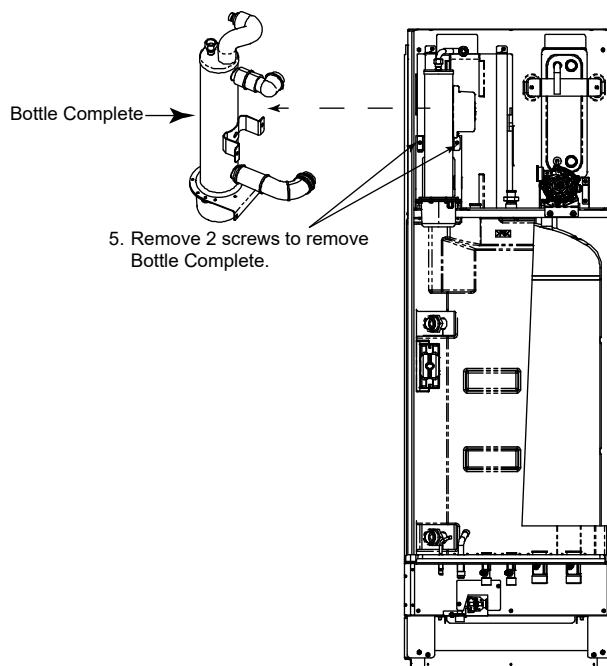
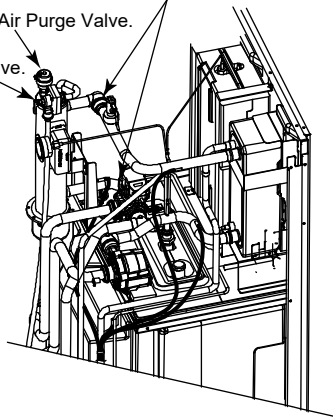

17.9 To Remove Anode Bar

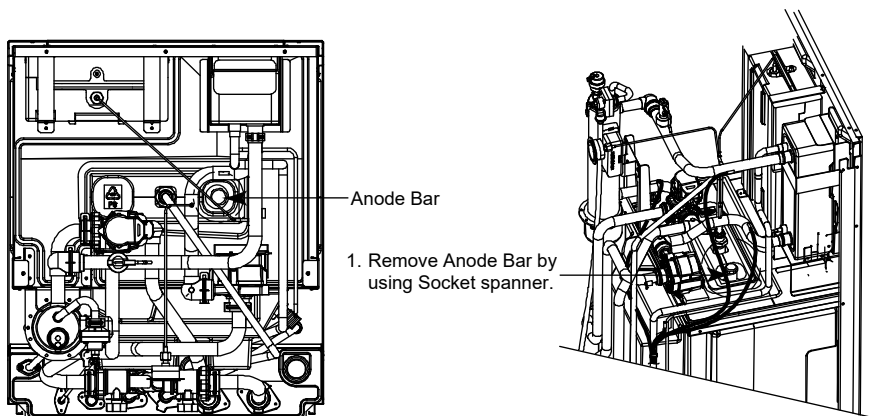

17.10 To Remove Water Filter

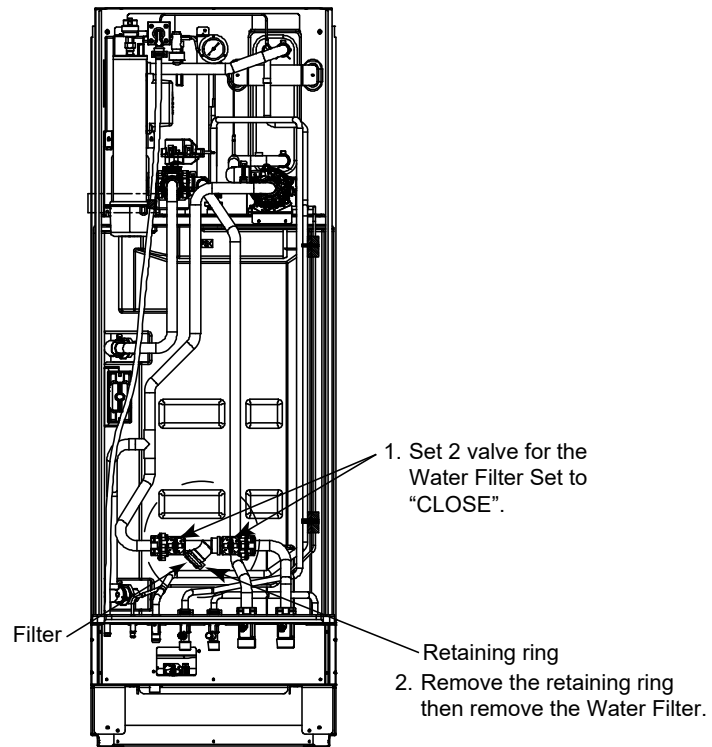

18. Technical Data

18.1 Operation Characteristics

18.1.1 WH-ADC1216G6E5 WH-UX09FE5

Heating Characteristics at Different Outdoor Air Temperature

Condition

Outdoor air temperature : 7°C (DBT), 6°C (WBT)

Indoor water inlet temperature : 30°C

Indoor water outlet temperature : 35°C

Piping length : 7 m

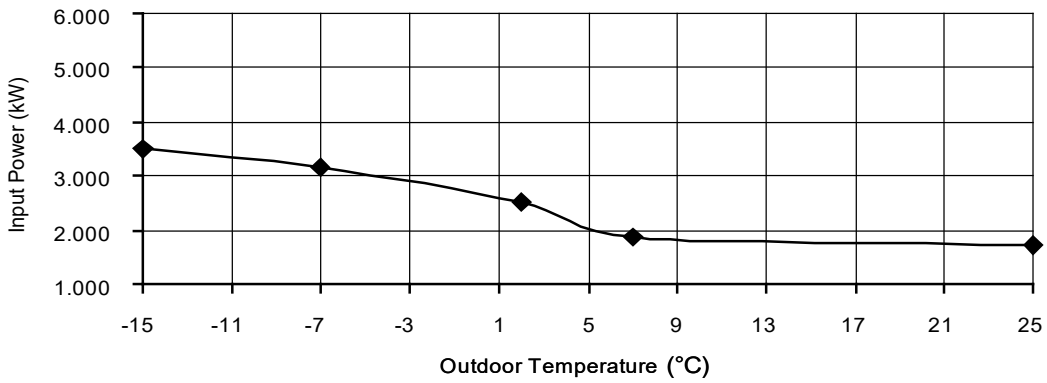
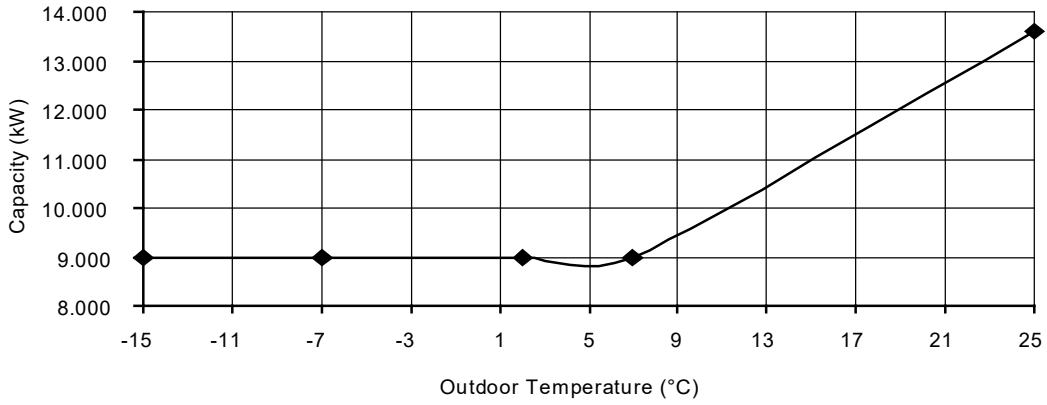

Cooling Characteristics at Different Outdoor Air Temperature

Condition

Outdoor air temperature : 35°C (DBT), -°C (WBT)

Indoor water inlet temperature : 12°C

Indoor water outlet temperature : 7°C

Piping length : 7 m

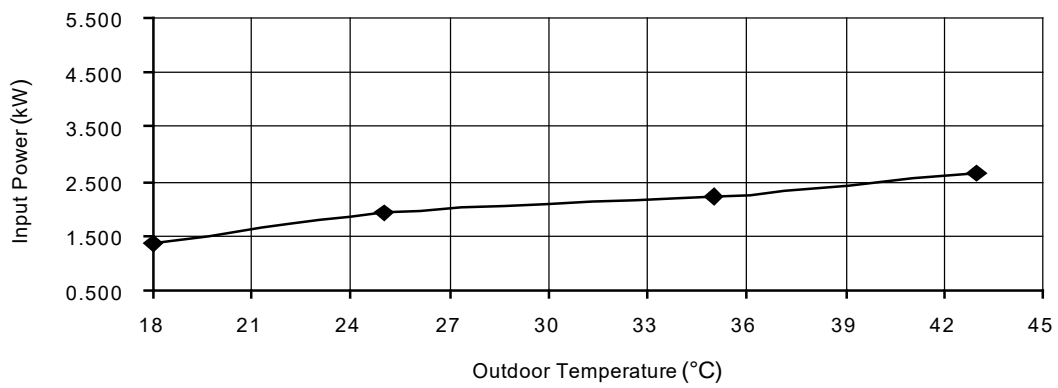
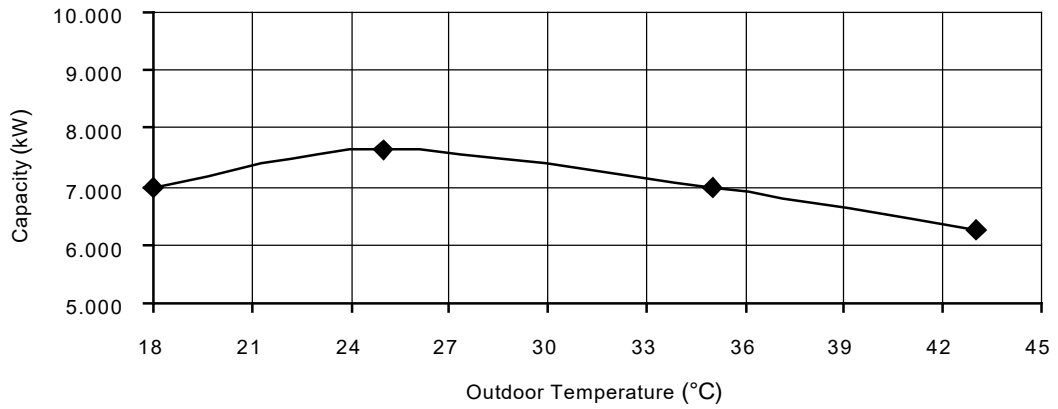

Cooling Characteristics at Different Outdoor Air Temperature

Condition

Outdoor air temperature : 35°C (DBT), -°C (WBT)

Indoor water inlet temperature : 19°C

Indoor water outlet temperature : 14°C

Piping length : 7 m

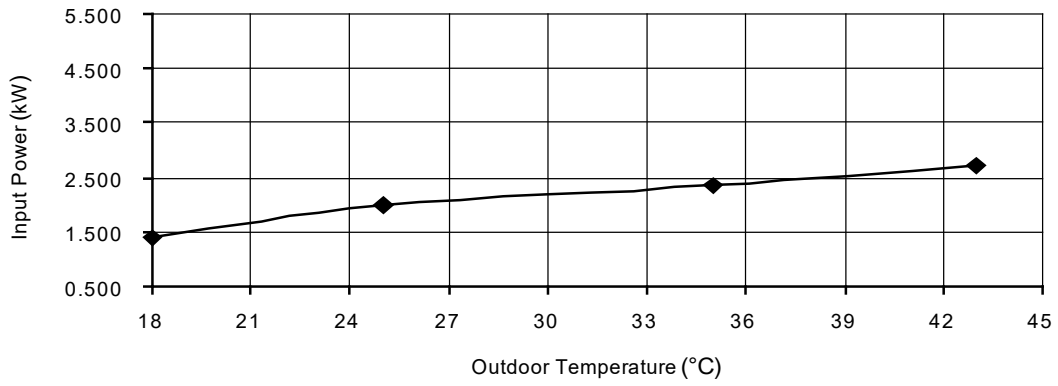
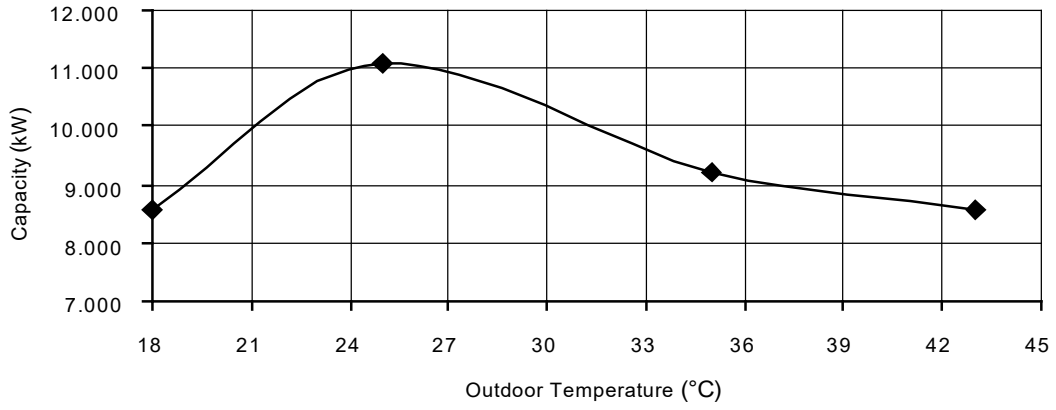

Cooling Characteristics at Different Outdoor Air Temperature

Condition

Outdoor air temperature : 35°C (DBT), -°C (WBT)

Indoor water inlet temperature : 23°C

Indoor water outlet temperature : 18°C

Piping length : 7 m

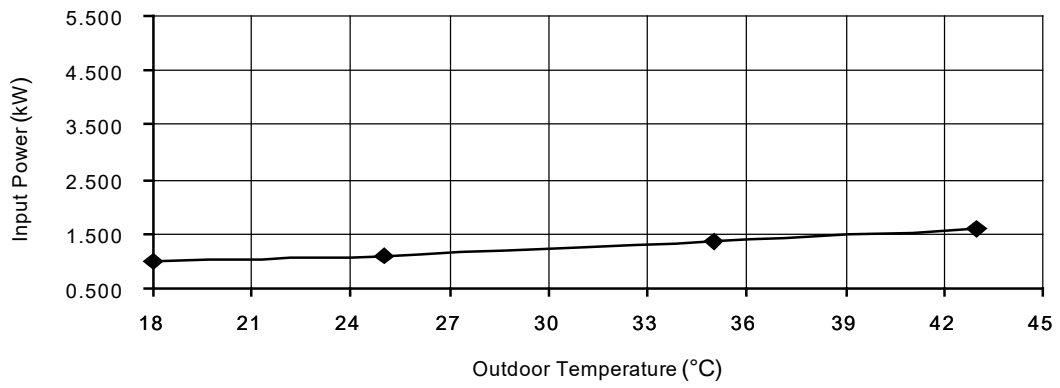
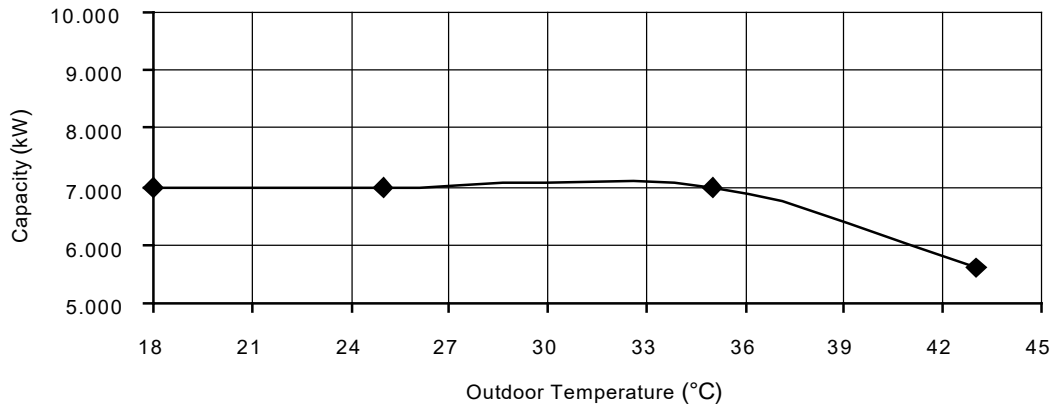

Heating Characteristics at Different Piping Length

Condition

Outdoor air temperature : 7°C (DBT), 6°C (WBT)

Indoor water inlet temperature : 30°C

Indoor water outlet temperature : 35°C

Piping length : 7 m

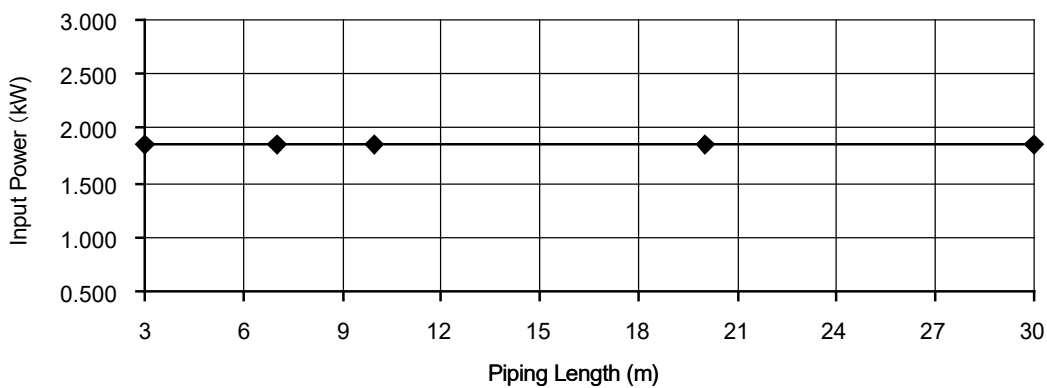
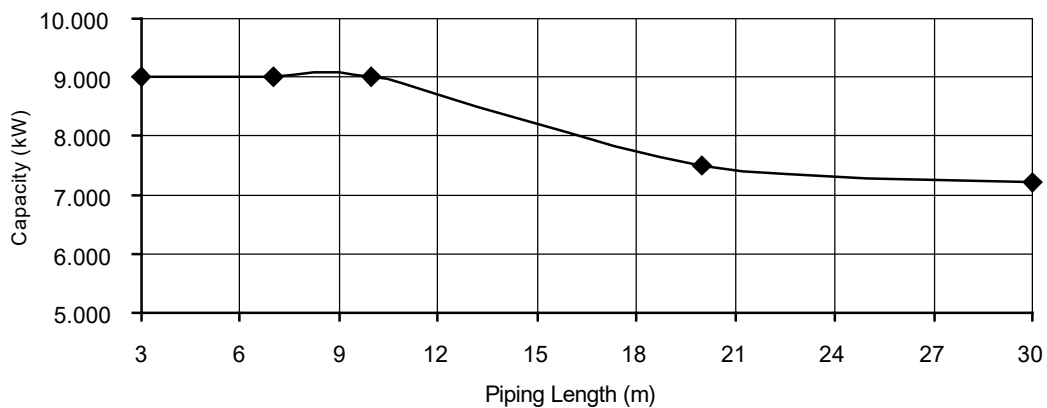

Cooling Characteristics at Different Piping Length

Condition

Outdoor air temperature : 35°C (DBT), -°C (WBT)

Indoor water inlet temperature : 12°C

Indoor water outlet temperature : 7°C

Piping length : 7 m

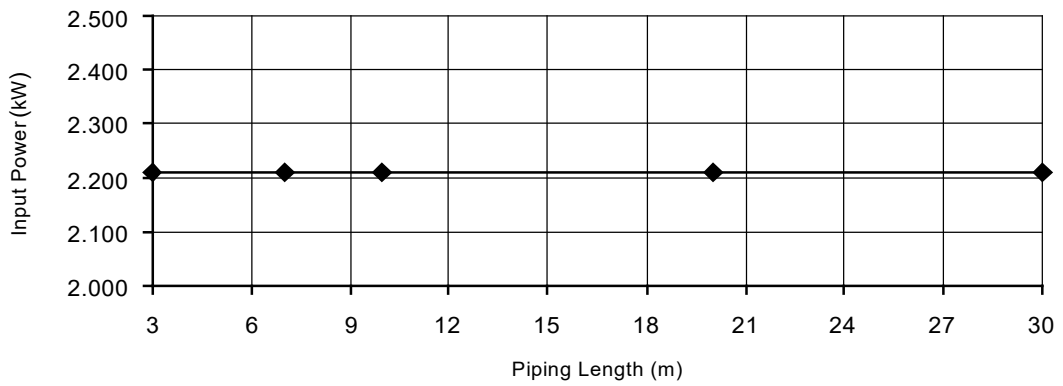
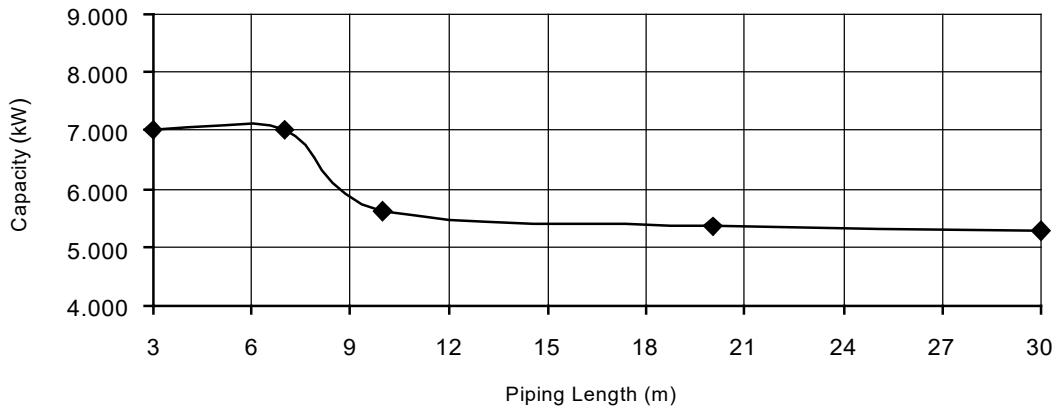

18.1.2 WH-ADC1216G6E5 WH-UX12FE5

Heating Characteristics at Different Outdoor Air Temperature

Condition

Outdoor air temperature : 7°C (DBT), 6°C (WBT)

Indoor water inlet temperature : 30°C

Indoor water outlet temperature : 35°C

Piping length : 7 m

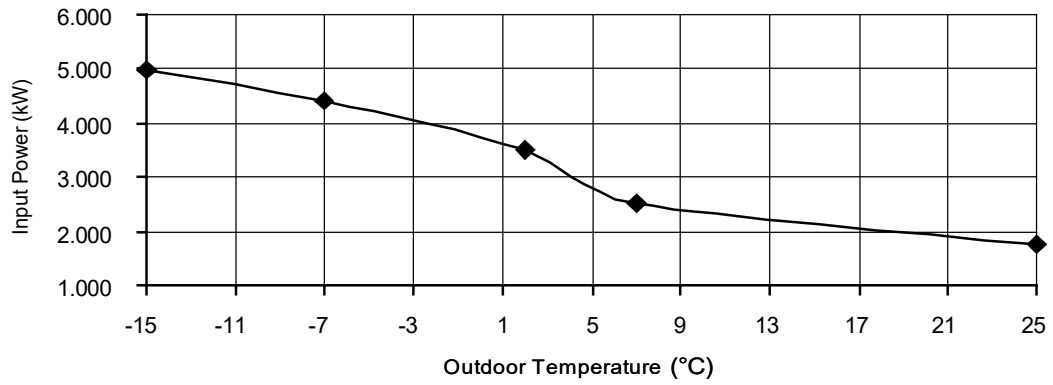
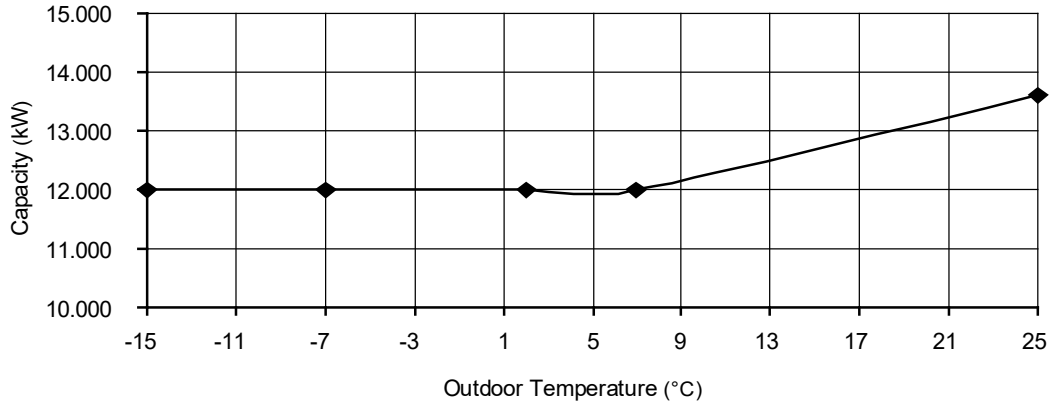

Cooling Characteristics at Different Outdoor Air Temperature

Condition

Outdoor air temperature : 35°C (DBT), -°C (WBT)

Indoor water inlet temperature : 12°C

Indoor water outlet temperature : 7°C

Piping length : 7 m

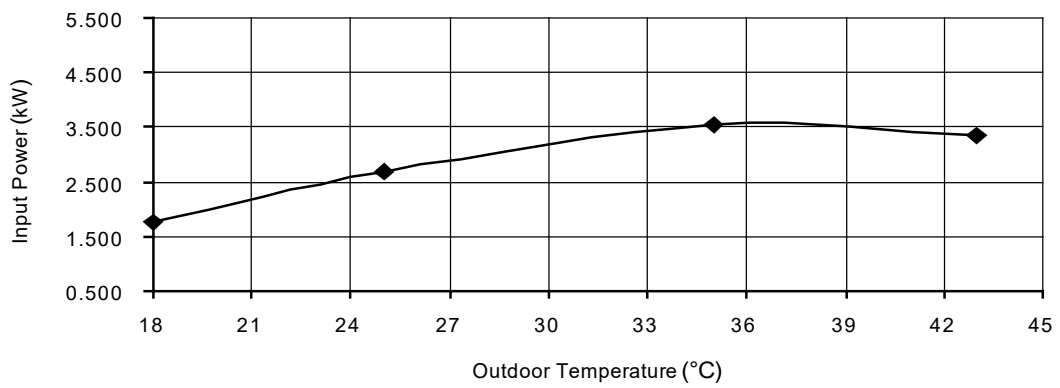
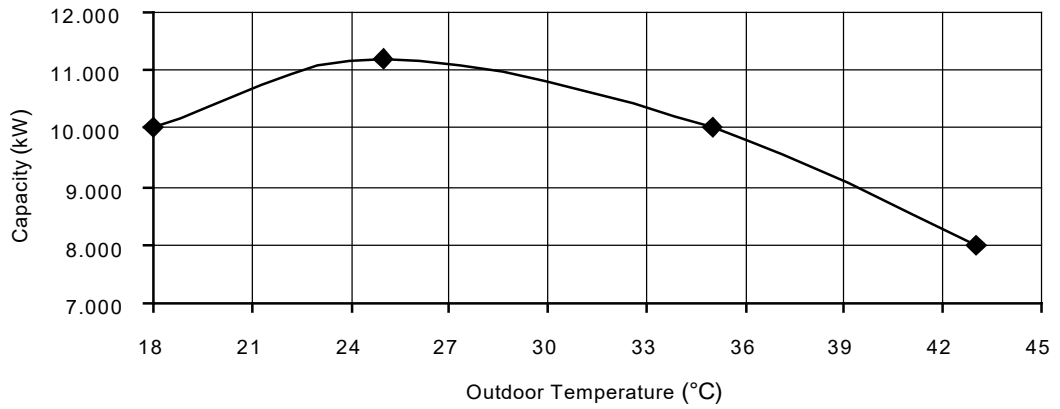

Cooling Characteristics at Different Outdoor Air Temperature

Condition

Outdoor air temperature : 35°C (DBT), -°C (WBT)

Indoor water inlet temperature : 19°C

Indoor water outlet temperature : 14°C

Piping length : 7 m

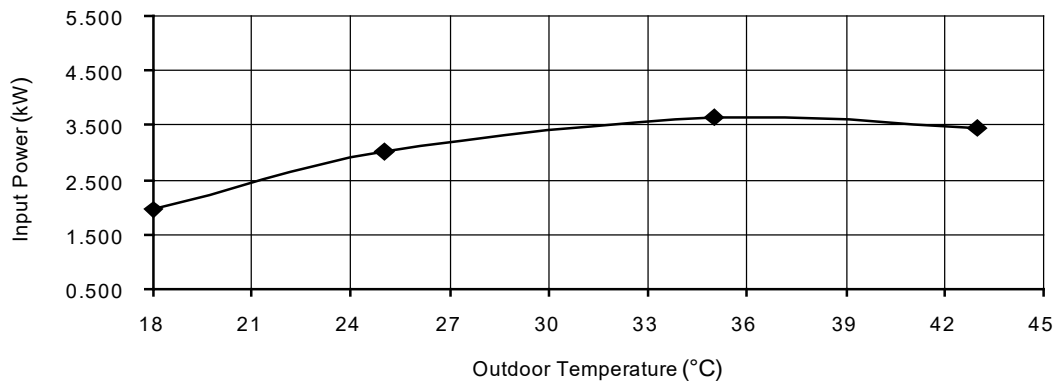
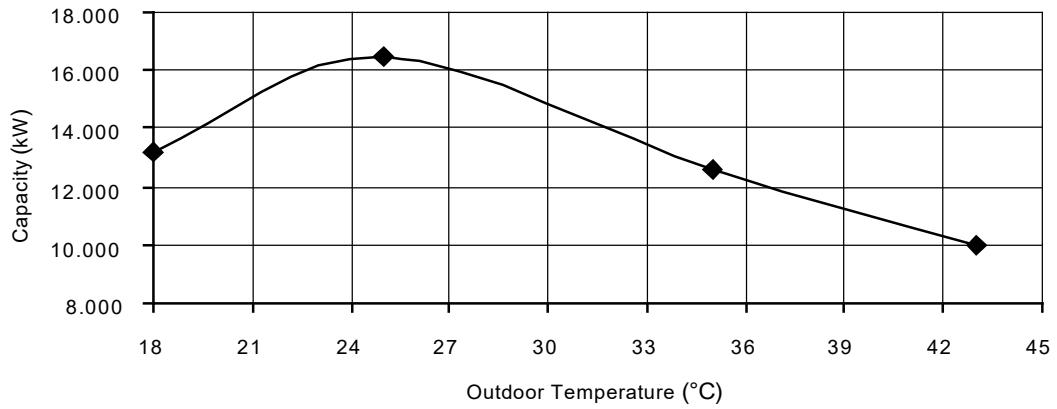

Cooling Characteristics at Different Outdoor Air Temperature

Condition

Outdoor air temperature : 35°C (DBT), -°C (WBT)

Indoor water inlet temperature : 23°C

Indoor water outlet temperature : 18°C

Piping length : 7 m

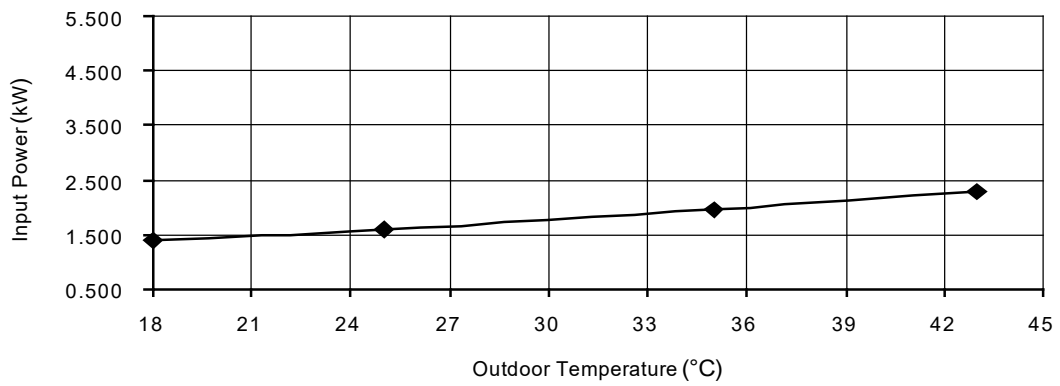
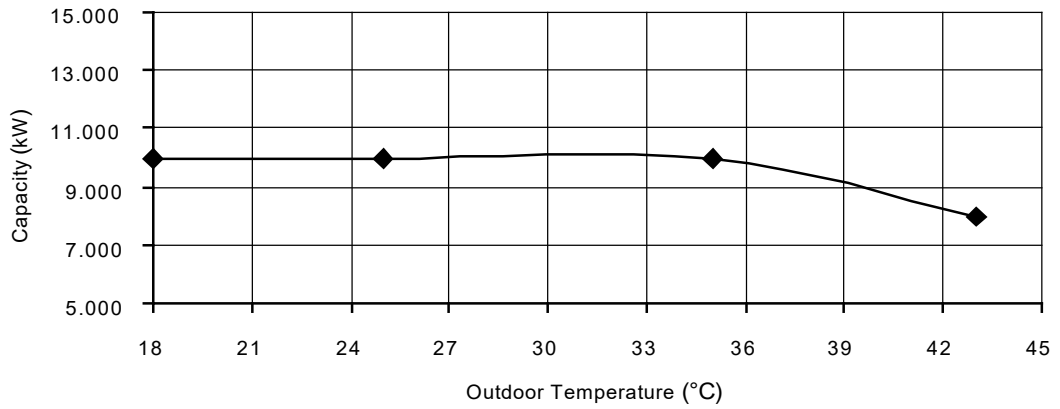

Heating Characteristics at Different Piping Length

Condition

Outdoor air temperature : 7°C (DBT), 6°C (WBT)

Indoor water inlet temperature : 30°C

Indoor water outlet temperature : 35°C

Piping length : 7 m

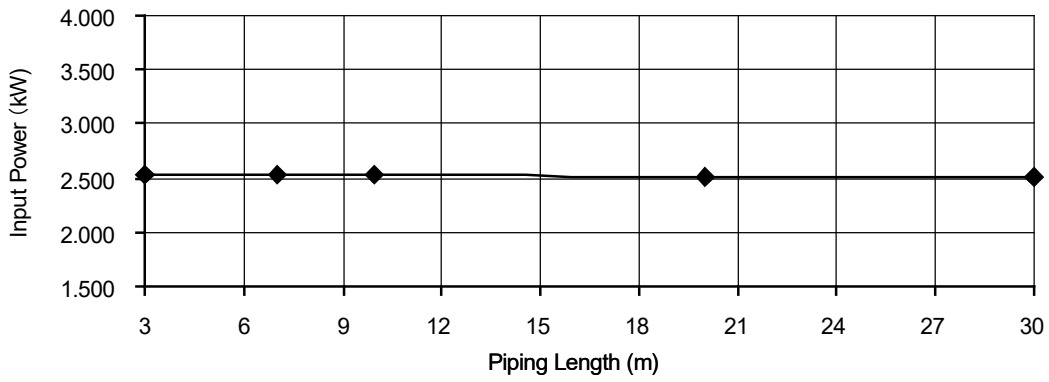
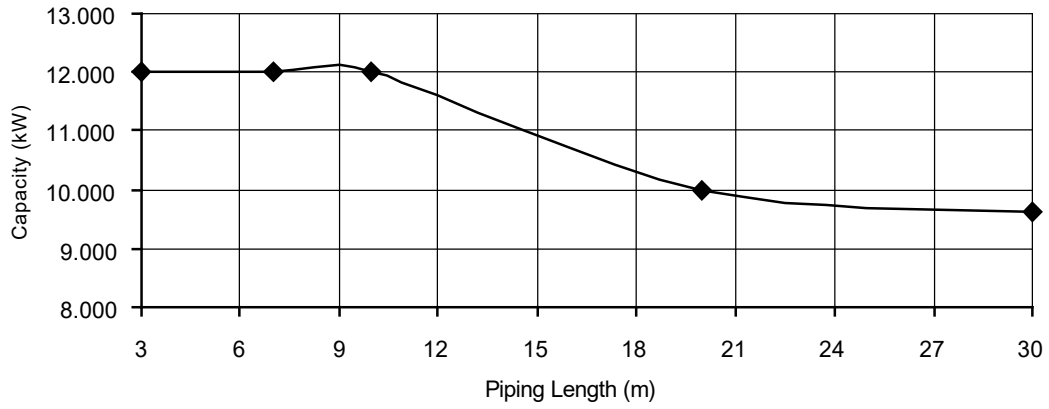

Cooling Characteristics at Different Piping Length

Condition

Outdoor air temperature : 35°C (DBT), -°C (WBT)

Indoor water inlet temperature : 12°C

Indoor water outlet temperature : 7°C

Piping length : 7 m

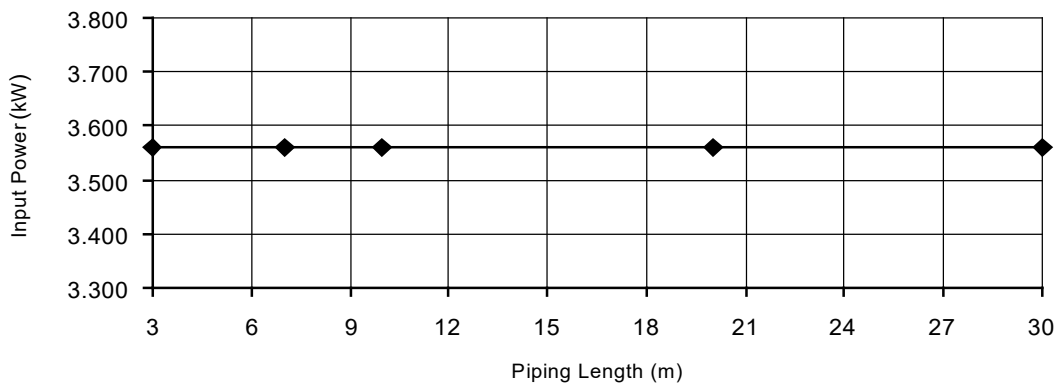
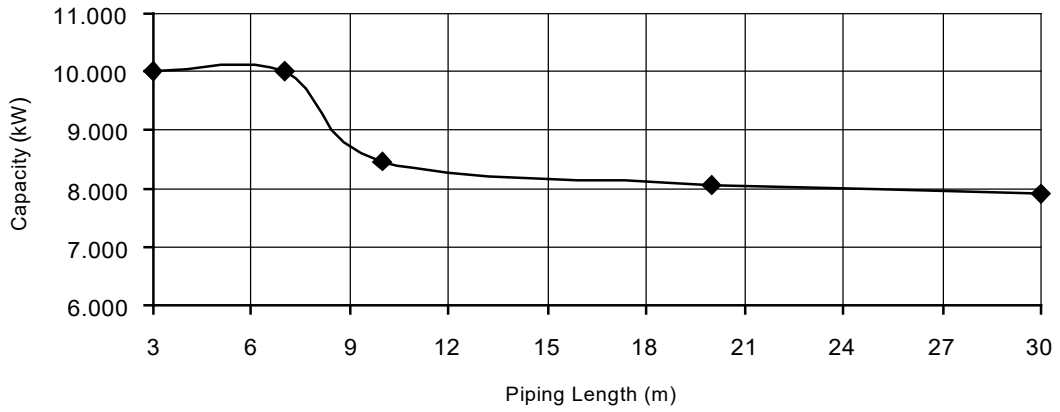

18.1.3 WH-ADC1216G6E5 WH-UD12FE5

Heating Characteristics at Different Outdoor Air Temperature

Condition

Outdoor air temperature : 7°C (DBT), 6°C (WBT)

Indoor water inlet temperature : 30°C

Indoor water outlet temperature : 35°C

Piping length : 7 m

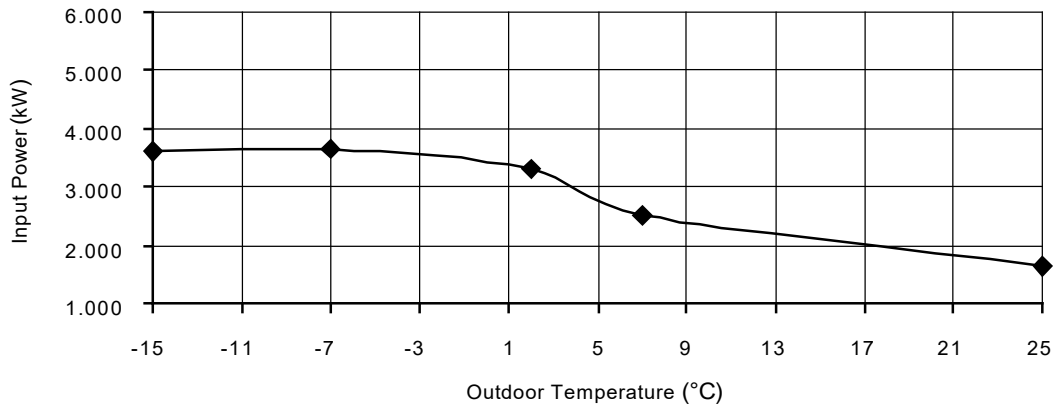
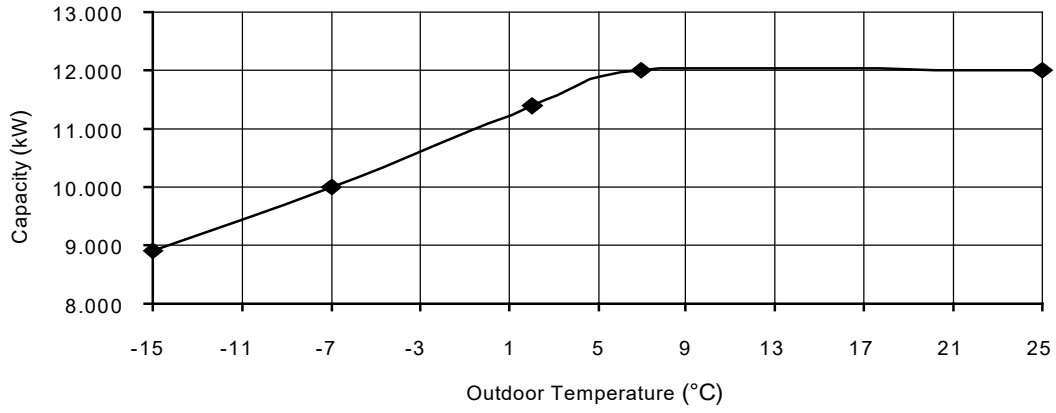

Cooling Characteristics at Different Outdoor Air Temperature

Condition

Outdoor air temperature : 35°C (DBT), -°C (WBT)

Indoor water inlet temperature : 12°C

Indoor water outlet temperature : 7°C

Piping length : 7 m

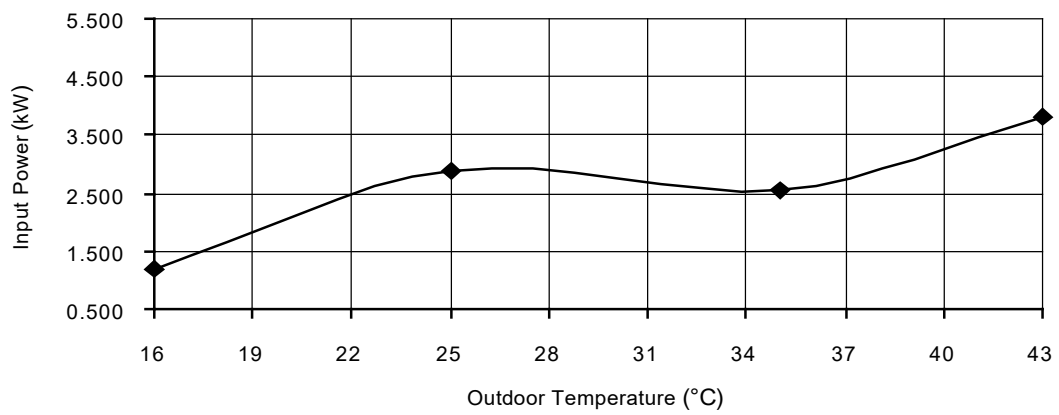
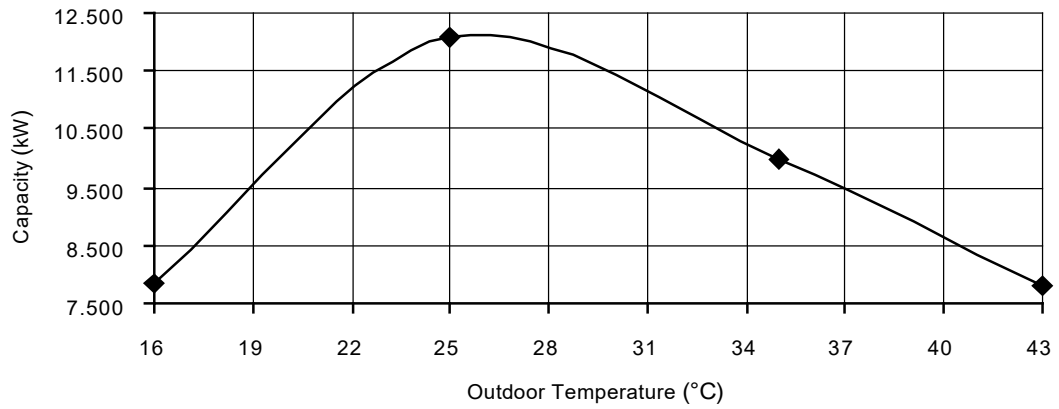

Cooling Characteristics at Different Outdoor Air Temperature

Condition

Outdoor air temperature : 35°C (DBT), -°C (WBT)

Indoor water inlet temperature : 19°C

Indoor water outlet temperature : 14°C

Piping length : 7 m

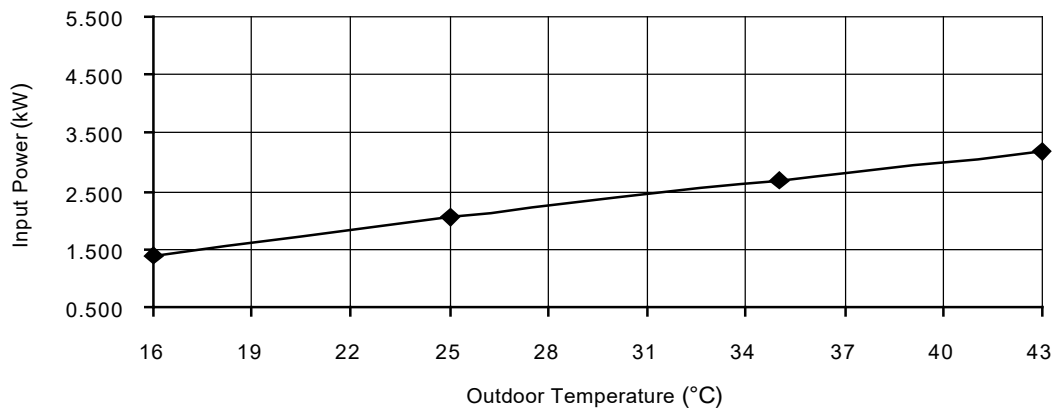
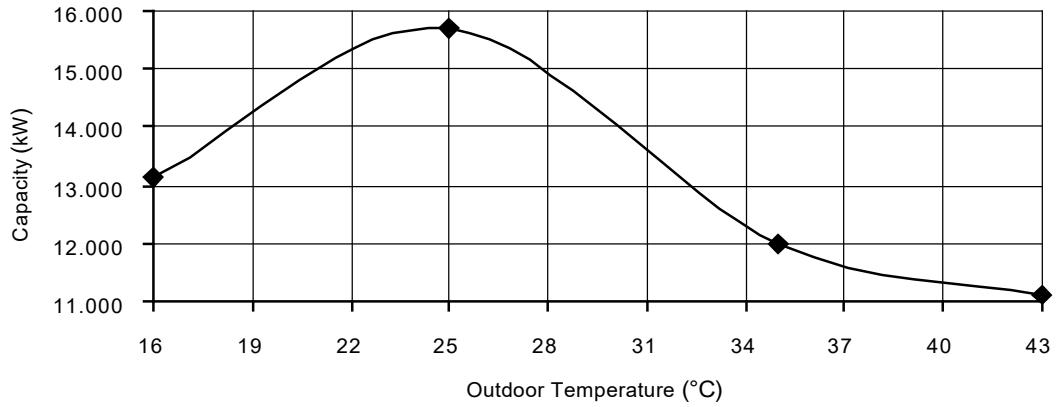

Cooling Characteristics at Different Outdoor Air Temperature

Condition

Outdoor air temperature : 35°C (DBT), -°C (WBT)

Indoor water inlet temperature : 23°C

Indoor water outlet temperature : 18°C

Piping length : 7 m

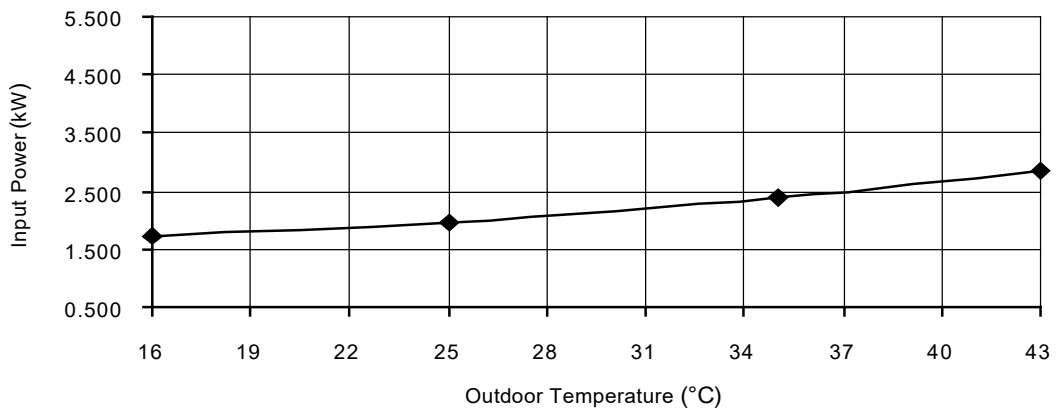
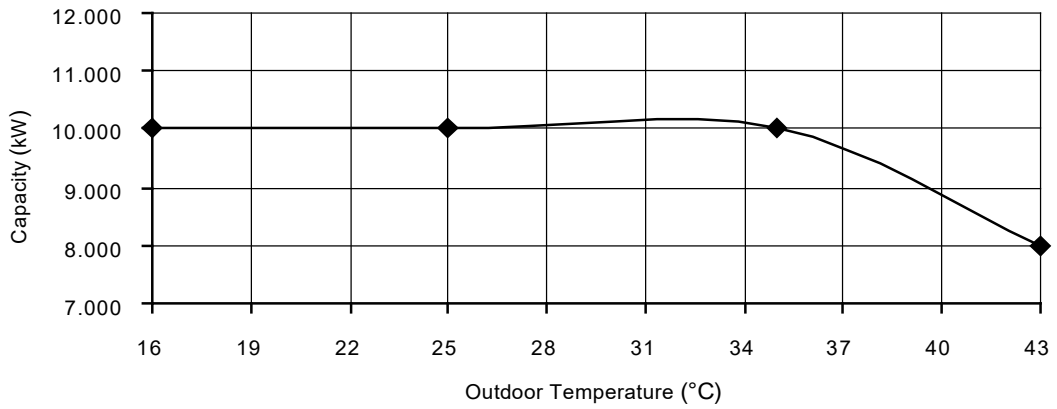

Heating Characteristics at Different Piping Length

Condition

Outdoor air temperature : 7°C (DBT), 6°C (WBT)

Indoor water inlet temperature : 30°C

Indoor water outlet temperature : 35°C

Piping length : 7 m

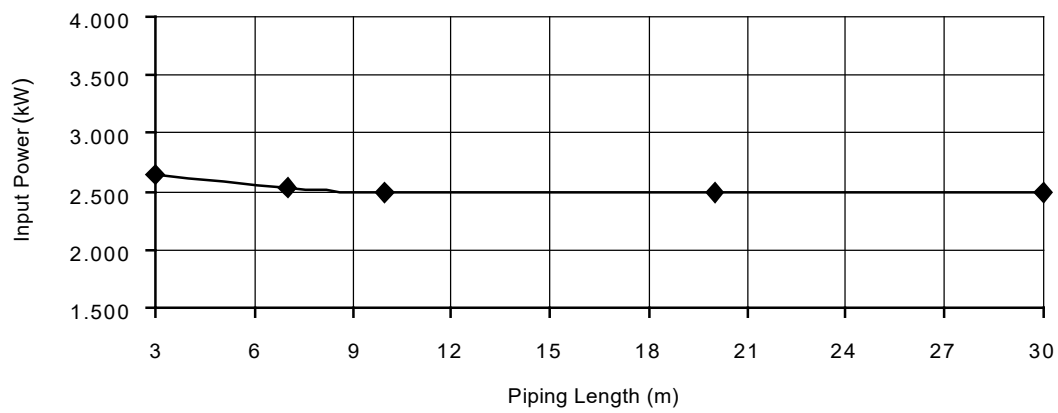
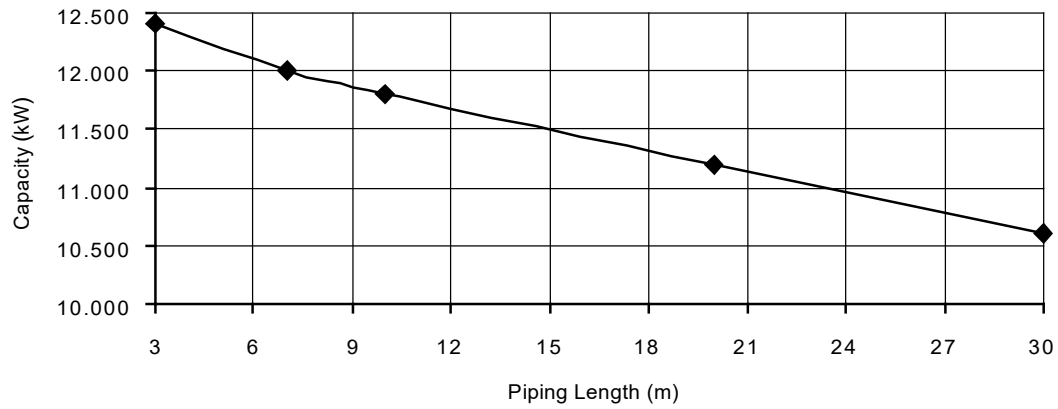

Cooling Characteristics at Different Piping Length

Condition

Outdoor air temperature : 35°C (DBT), -°C (WBT)

Indoor water inlet temperature : 12°C

Indoor water outlet temperature : 7°C

Piping length : 7 m

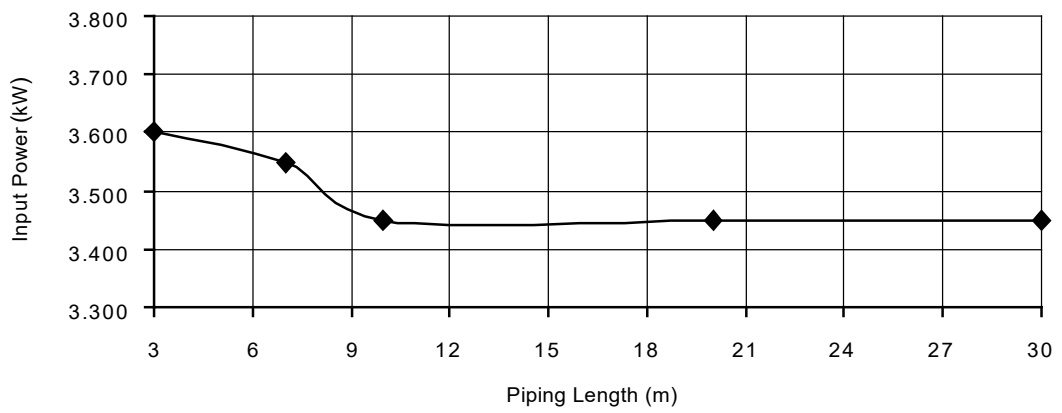
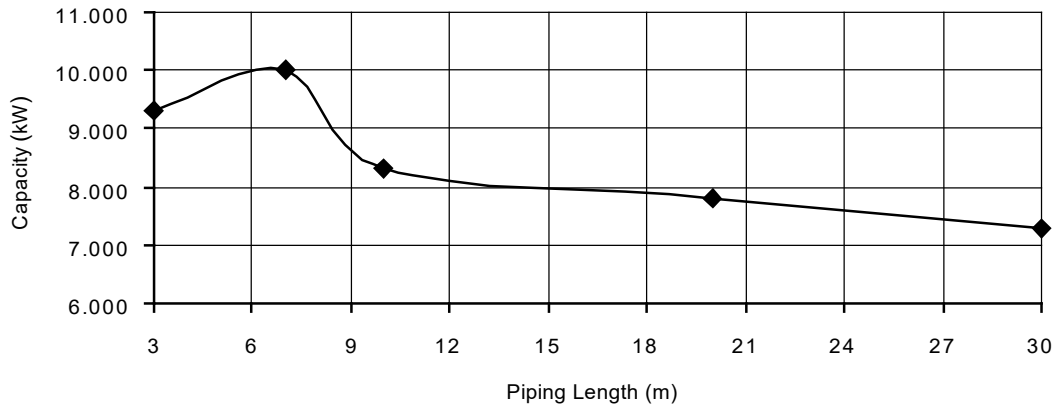

18.1.4 WH-ADC1216G6E5 WH-UD16FE5

Heating Characteristics at Different Outdoor Air Temperature

Condition

Outdoor air temperature : 7°C (DBT), 6°C (WBT)

Indoor water inlet temperature : 30°C

Indoor water outlet temperature : 35°C

Piping length : 7 m

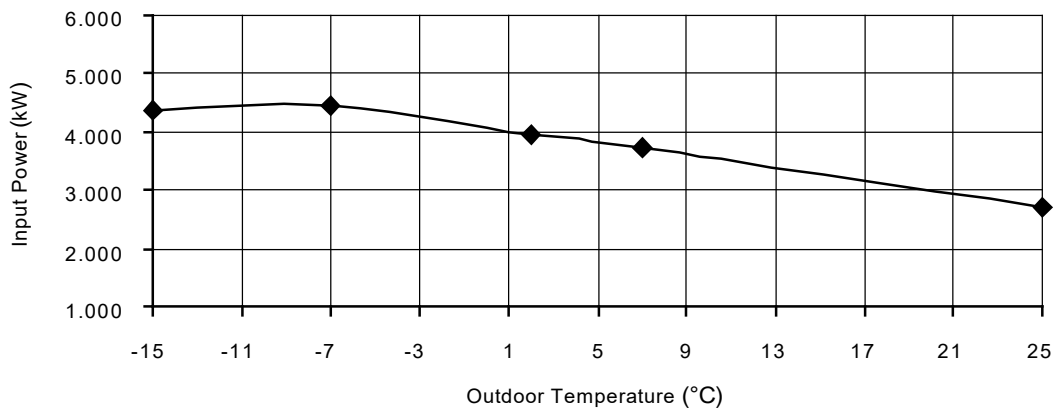
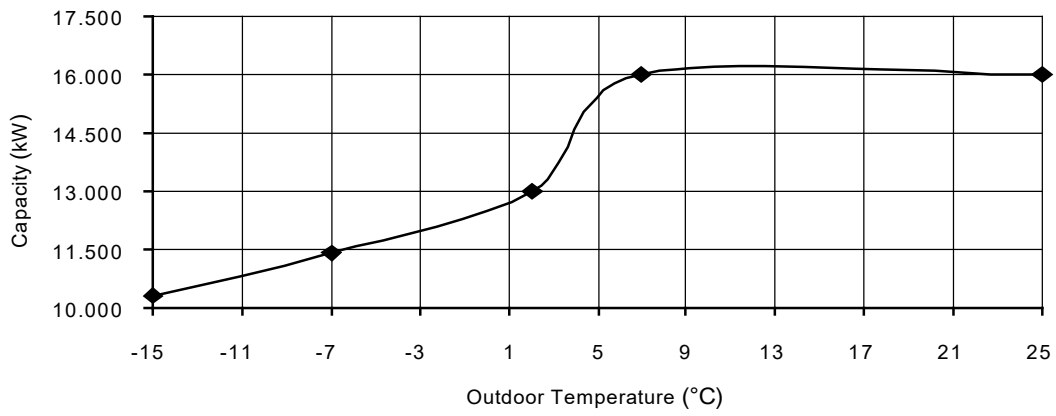

Cooling Characteristics at Different Outdoor Air Temperature

Condition

Outdoor air temperature : 35°C (DBT), -°C (WBT)

Indoor water inlet temperature : 12°C

Indoor water outlet temperature : 7°C

Piping length : 7 m

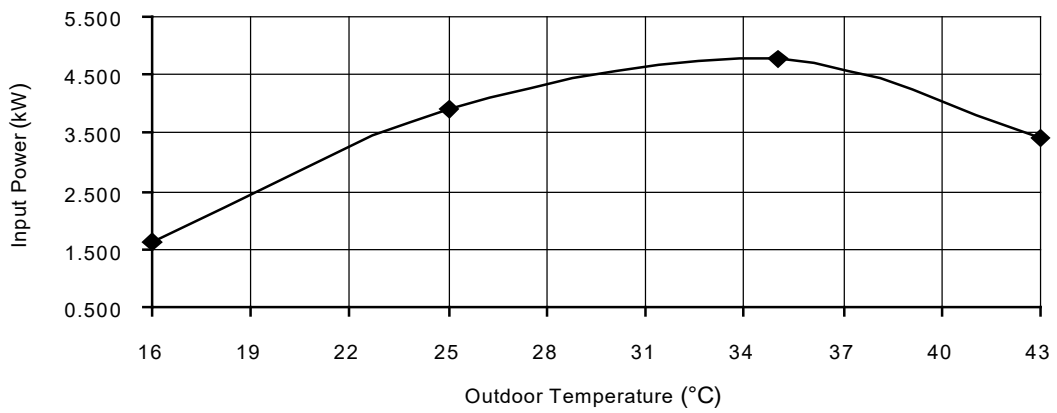
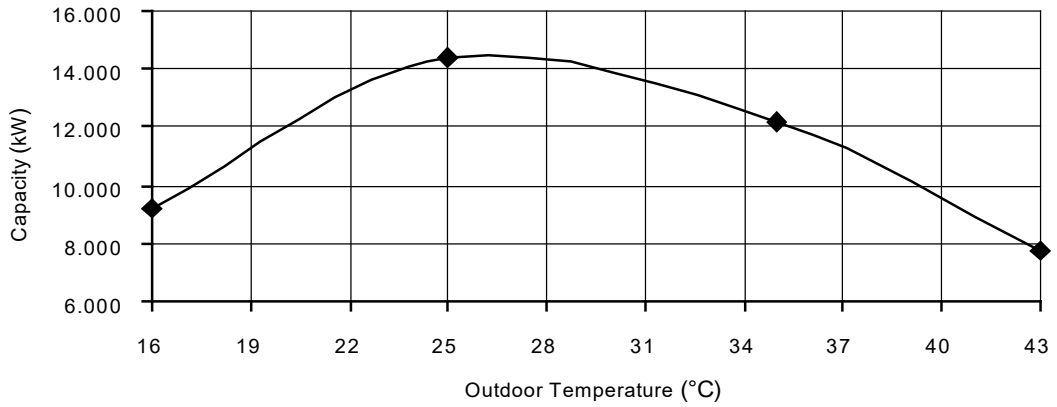

Cooling Characteristics at Different Outdoor Air Temperature

Condition

Outdoor air temperature : 35°C (DBT), -°C (WBT)

Indoor water inlet temperature : 19°C

Indoor water outlet temperature : 14°C

Piping length : 7 m

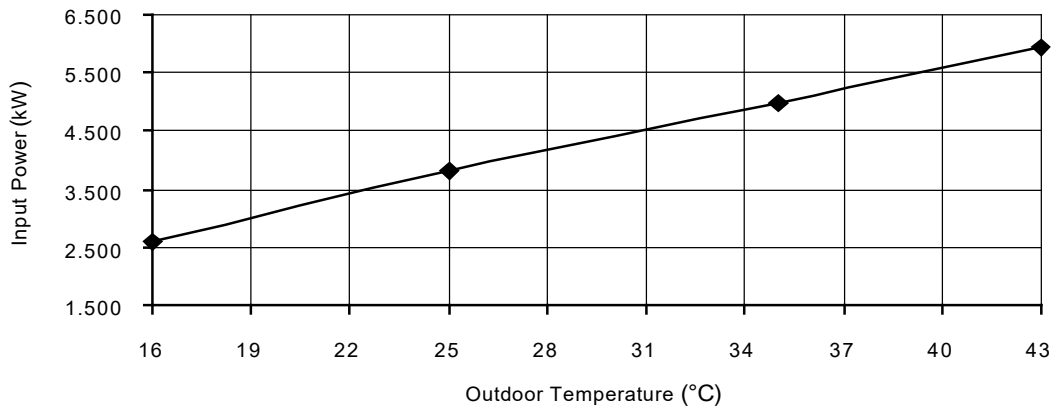
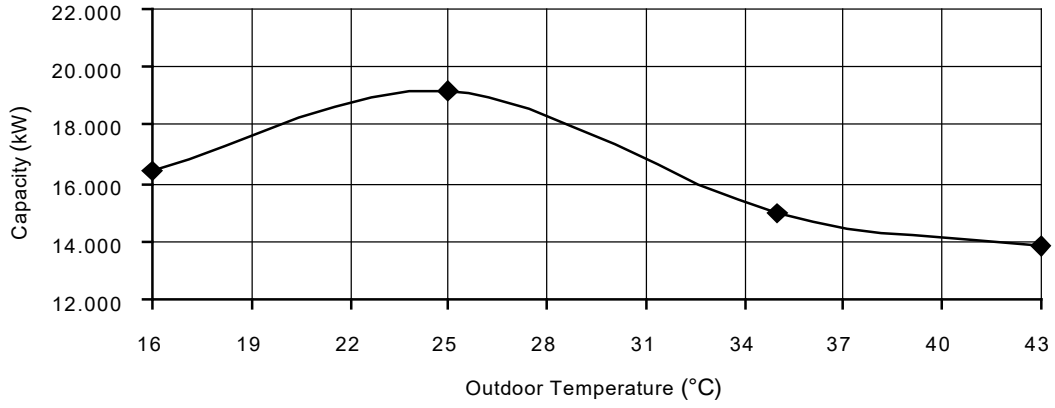

Cooling Characteristics at Different Outdoor Air Temperature

Condition

Outdoor air temperature : 35°C (DBT), -°C (WBT)

Indoor water inlet temperature : 23°C

Indoor water outlet temperature : 18°C

Piping length : 7 m

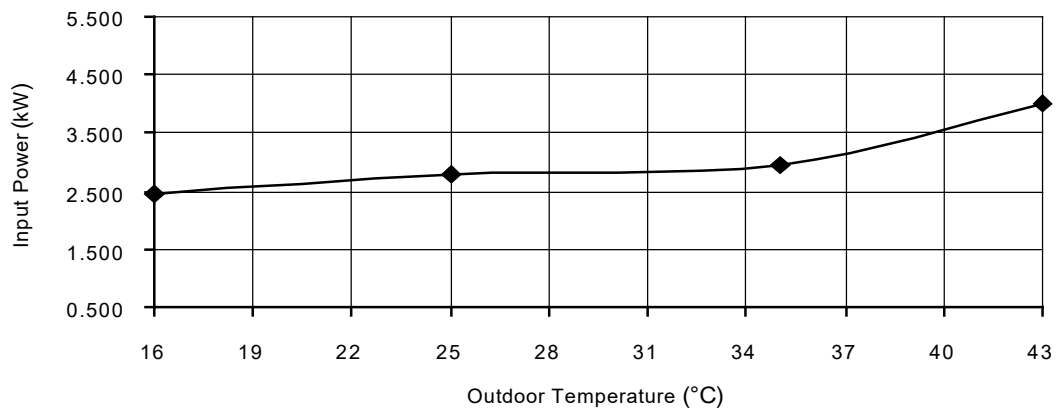
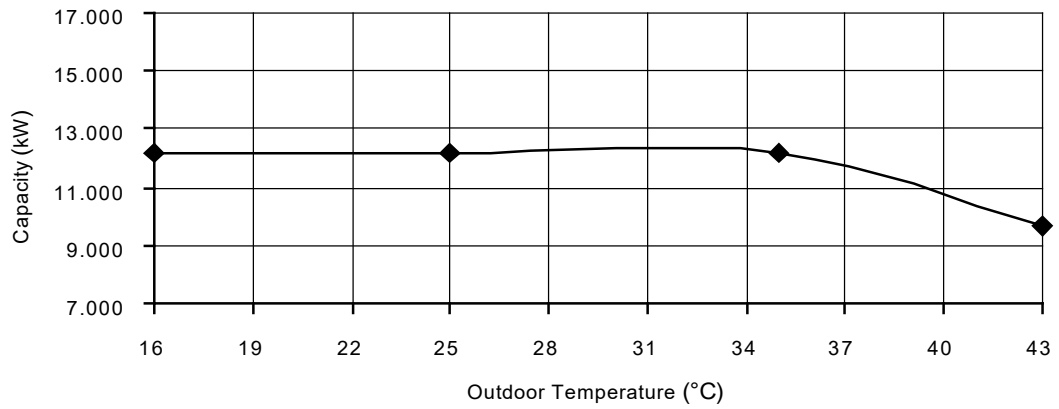

Heating Characteristics at Different Piping Length

Condition

Outdoor air temperature : 7°C (DBT), 6°C (WBT)

Indoor water inlet temperature : 30°C

Indoor water outlet temperature : 35°C

Piping length : 7 m

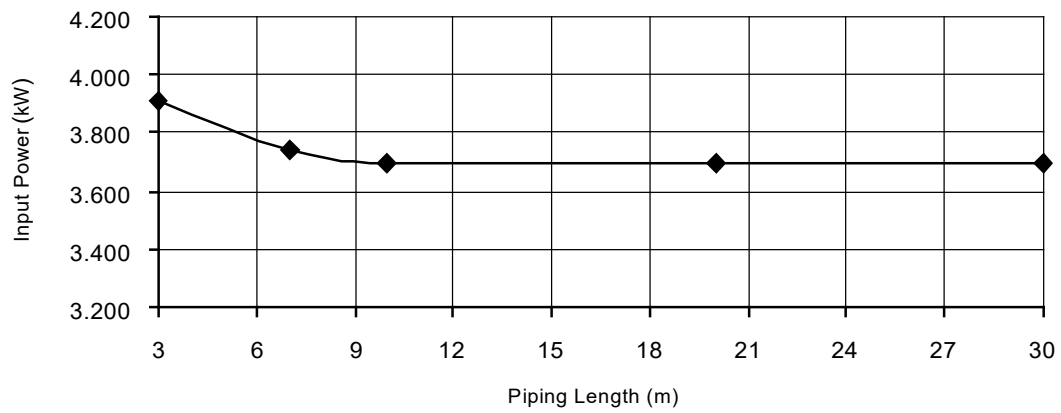
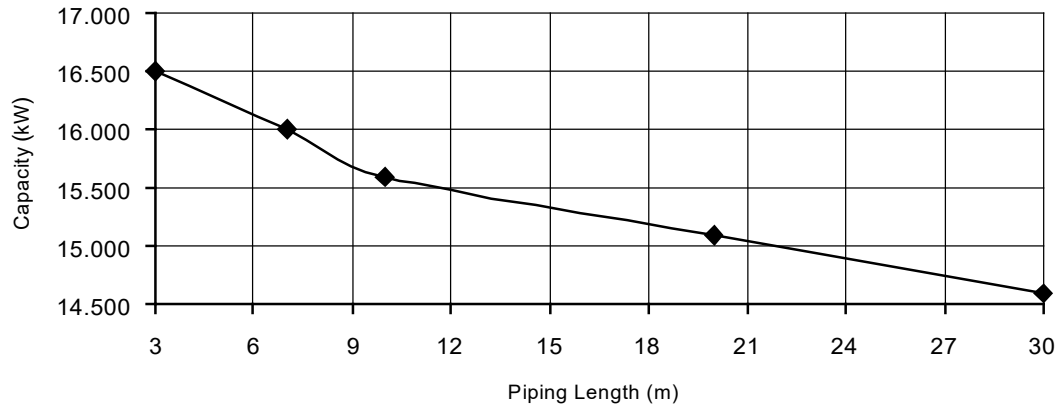

Cooling Characteristics at Different Piping Length

Condition

Outdoor air temperature : 35°C (DBT), -°C (WBT)

Indoor water inlet temperature : 12°C

Indoor water outlet temperature : 7°C

Piping length : 7 m

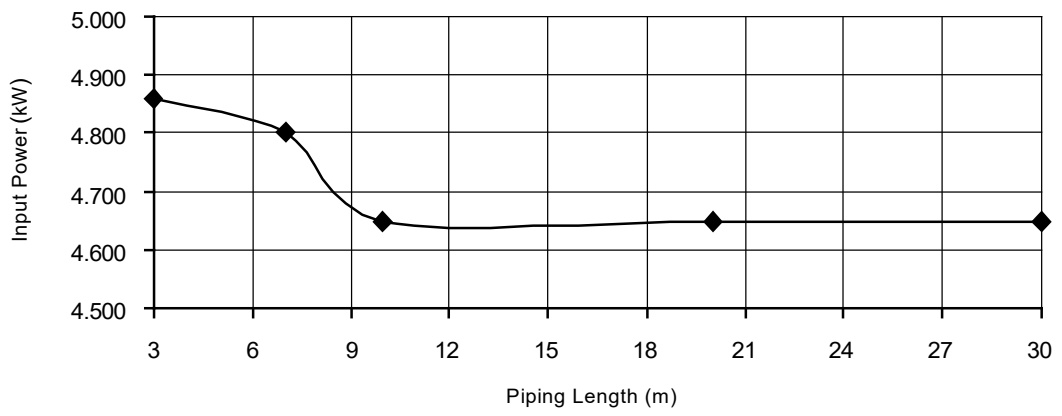
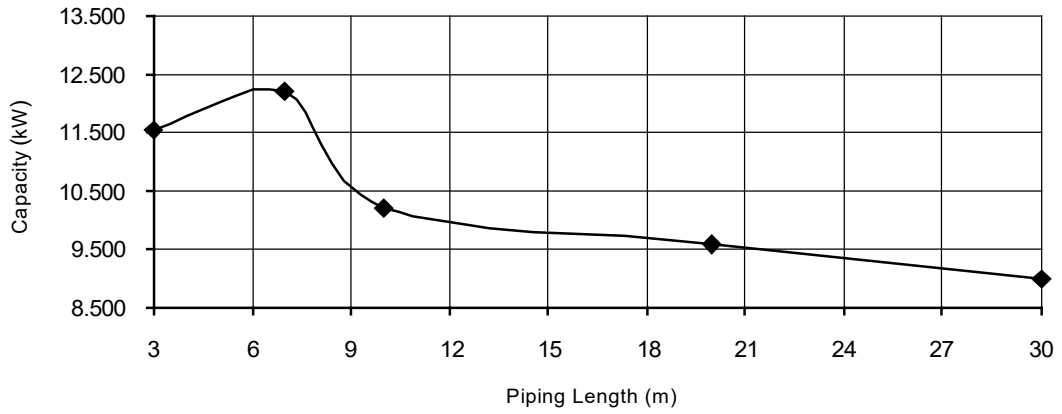

18.2 Heating Capacity Table

18.2.1 WH-UX09FE5

Water Out (°C)	30		35		40		45		50		55	
Outdoor Air (°C)	Capacity (W)	Input Power (W)	Capacity (W)	Input Power (W)	Capacity (W)	Input Power (W)	Capacity (W)	Input Power (W)	Capacity (W)	Input Power (W)	Capacity (W)	Input Power (W)
-15	9000	3240	9000	3510	9000	3910	9000	4300	9000	4730	9000	5160
-7	9000	2710	9000	3160	9000	3620	9000	4070	9000	4270	9000	4460
2	9000	2360	9000	2510	9000	2780	9000	3050	9000	3560	9000	4070
7	9000	1640	9000	1860	9000	2160	9000	2460	9000	2760	9000	3060
25	13600	1500	13600	1710	13200	1930	12800	2140	12000	2410	11200	2670

18.2.2 WH-UX12FE5

Water Out (°C)	30		35		40		45		50		55	
Outdoor Air (°C)	Capacity (W)	Input Power (W)	Capacity (W)	Input Power (W)	Capacity (W)	Input Power (W)	Capacity (W)	Input Power (W)	Capacity (W)	Input Power (W)	Capacity (W)	Input Power (W)
-15	12000	4750	12000	4960	12000	5410	11000	5380	10800	5820	10500	6260
-7	12000	3850	12000	4410	12000	4980	12000	5540	12000	5900	12000	6260
2	12000	3190	12000	3490	12000	3870	12000	4250	12000	4860	12000	5470
7	12000	2180	12000	2530	12000	2960	12000	3390	12000	3780	12000	4160
25	13600	1550	13600	1760	13400	2100	13200	2430	12600	2660	12000	2890

18.2.3 WH-UD12FE5

Water Out (°C)	30		35		40		45		50		55	
Outdoor Air (°C)	Capacity (W)	Input Power (W)	Capacity (W)	Input Power (W)	Capacity (W)	Input Power (W)	Capacity (W)	Input Power (W)	Capacity (W)	Input Power (W)	Capacity (W)	Input Power (W)
-15	9300	3460	8900	3620	8500	3790	8100	3950	7500	4050	7000	4160
-7	10400	3370	10000	3660	9600	3950	9200	4240	8700	4260	8200	4270
2	11800	3100	11400	3310	11000	3530	10600	3740	9800	3940	9100	4140
7	12000	2100	12000	2530	12000	2960	12000	3390	12000	3780	12000	4160
25	12000	1380	12000	1660	11800	1940	11700	2230	11500	2490	11400	2740

18.2.4 WH-UD16FE5

Water Out (°C)	30		35		40		45		50		55	
Outdoor Air (°C)	Capacity (W)	Input Power (W)	Capacity (W)	Input Power (W)	Capacity (W)	Input Power (W)	Capacity (W)	Input Power (W)	Capacity (W)	Input Power (W)	Capacity (W)	Input Power (W)
-15	10600	4090	10300	4380	10000	4670	9700	4960	8800	4940	7900	4910
-7	11900	4030	11400	4430	10800	4830	10300	5220	9600	5090	9000	4950
2	13500	3740	13000	3960	12400	4180	11900	4400	10800	4460	9800	4510
7	16000	3210	16000	3740	16000	4270	16000	4800	15200	5110	14500	5410
25	16000	2310	16000	2960	16000	3070	16000	3450	16000	3670	15900	3890

18.3 Cooling Capacity Table

18.3.1 WH-ADC1216G6E5 WH-UX09FE5

Water In (°C)	12		19		23	
Water Out (°C)	7		14		18	
Outdoor Air (°C)	Capacity (W)	Input Power (W)	Capacity (W)	Input Power (W)	Capacity (W)	Input Power (W)
18	7000	1360	8550	1410	7000	1000
25	7650	1910	11100	1980	7000	1100
35	7000	2210	9230	2370	7000	1350
43	6250	2660	8550	2710	5600	1600

18.3.2 WH-ADC1216G6E5 WH-UX12FE5

Water In (°C)	12		19		23	
Water Out (°C)	7		14		18	
Outdoor Air (°C)	Capacity (W)	Input Power (W)	Capacity (W)	Input Power (W)	Capacity (W)	Input Power (W)
18	10000	1750	13200	1960	10000	1400
25	11200	2670	16500	3010	10000	1600
35	10000	3560	12550	3630	10000	1950
43	8000	3350	10000	3460	8000	2300

18.3.3 WH-ADC1216G6E5 WH-UD12FE5

Water In (°C)	12		19		23	
Water Out (°C)	7		14		18	
Outdoor Air (°C)	Capacity (W)	Input Power (W)	Capacity (W)	Input Power (W)	Capacity (W)	Input Power (W)
16	7860	1180	13150	1400	10000	1730
25	12080	2900	15700	2050	10000	1970
35	10000	2560	12000	2670	10000	2400
43	7800	3800	11100	3190	8000	2850

18.3.4 WH-ADC1216G6E5 WH-UD16FE5

Water In (°C)	12		19		23	
Water Out (°C)	7		14		18	
Outdoor Air (°C)	Capacity (W)	Input Power (W)	Capacity (W)	Input Power (W)	Capacity (W)	Input Power (W)
16	9200	1620	16400	2580	12200	2450
25	14400	3920	19200	3830	12200	2790
35	12200	4760	15000	4980	12200	2960
43	7750	3400	13800	5950	9700	4000

19. Exploded View and Replacement Parts List

19.1 Indoor Unit

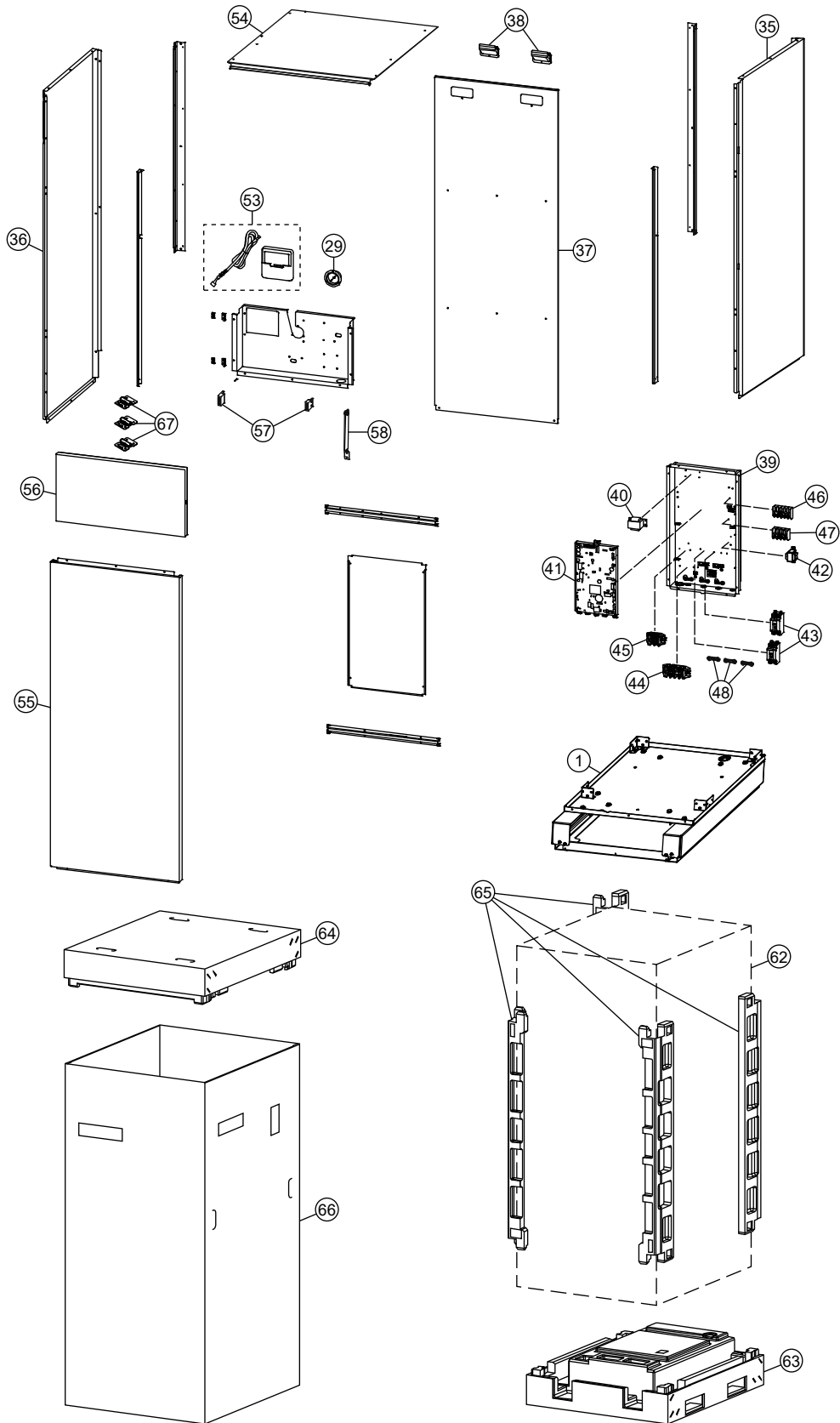

Note:

- The above exploded view is for the purpose of parts disassembly and replacement.
- The non-numbered parts are not kept as standard service parts.

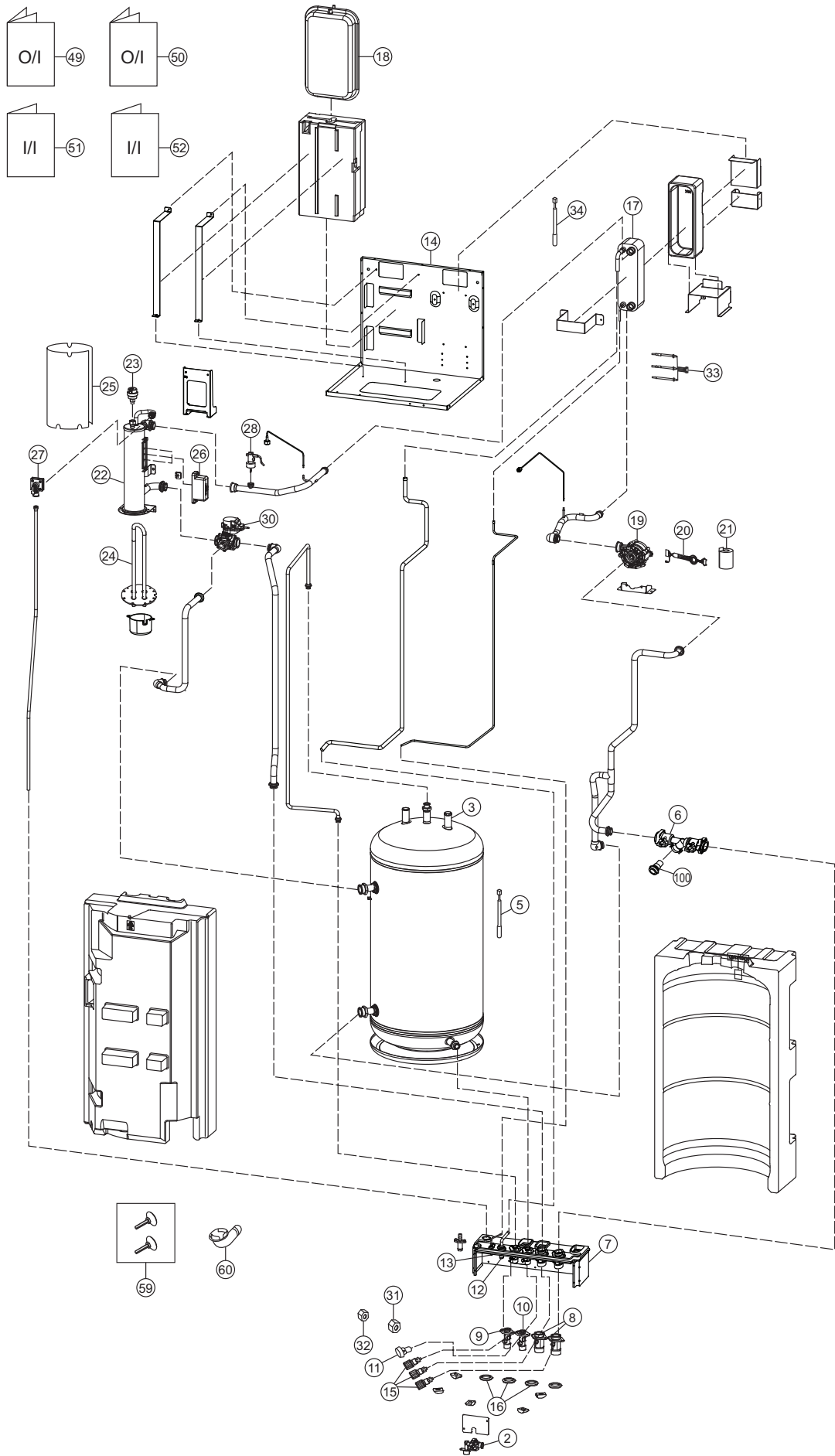

Note:

- The above exploded view is for the purpose of parts disassembly and replacement.
- The non-numbered parts are not kept as standard service parts.

SAFETY	REF. NO.	DESCRIPTION	QTY.	WH-ADC1216G6E5	REMARK
	1	CHASSIS COMPLETE	1	CWD50C1855	
	2	DRAIN VALVE	1	CWB65C1025	O
	3	ANODE BAR	1	56200	*
	5	SENSOR CO. (TANK TEMP CN-TH2)	1	CWA50C3257	O
	6	FILTER COMPLETE	1	CWB51C1021	O
	7	HOLDER-COUPLING	1	CWH351306	
	8	TUBE CONNECTER (WATER IN OUT)	2	CWT291196	
	9	TUBE CONNECTER (DOMESTIC HOT WATER IN OUT)	1	CWT291197	
	10	TUBE CONNECTER (DOMESTIC HOT WATER IN)	1	CWT291203	
	11	PRESSURE RELIEF VALVE (TUBE CON. DOMESTIC HOT WATER IN)	1	CWB62C1198	O
	12	TUBE CONNECTER (REF. GAS)	1	CWT291199	
	13	TUBE CONNECTER (REF. LIQUID)	1	CWT291205	
	14	BASE PAN (HEATER)	1	CWD521419	
	15	PURGE PLUG	3	CWB821027	
	16	O-RING (PURGE PLUG)	3	CWB811190	
	17	HOT WATER COIL-COMPLETE	1	CWB90C1139	
	18	RECEIVER	1	CWB141073	
⚠	19	WATER PUMP	1	CWB532116	O
	20	LEAD WIRE FOR WATER PUMP	1	CWA68C1394	O
	21	FERRITE CORE	1	CWA431122	O
	22	BOTTLE COMPLETE	1	CWH90C0052	
	23	AIR PURGE VALVE	1	CWB621094	O
	24	HEATER ASS'Y	1	CWA34K1048	
	25	SOUND PROOF MATERIAL	1	CWG302906	
	26	THERMOSTAT	3	CWA151074	O
	27	PRESSURE RELIEF VALVE	1	CWB621092	
	28	FLOW SWITCH	1	CWB621128	O
	29	PRESSURE GAUGE	1	CWB070001	
	30	3 WAY VALVE (WATER)	1	CWB621134	
	31	FLARE NUT (5/8)	1	CWT251064	
	32	FLARE NUT (1/4)	1	CWT251063	
	33	SENSOR-CO. (WATER IN OUT, REF TEMP SENSOR CN-TH1)	1	CWA50C3259	O
	34	SENSOR-CO. (HEX WATER OUTLET TEMP CN-TH3)	1	CWA50C3260	O
	35	CABINET SIDE PLATE (R)	1	CWE041824A	
	36	CABINET SIDE PLATE (L)	1	CWE041825A	
	37	CABINET REAR PLATE	1	CWE021129	
	38	HANDLE	2	CWE161014	
	39	CONTROL BOARD	1	CWH102622	
	40	TRANSFORMER COMPLETE	1	CWA40C1096	O
⚠	41	ELECTRONIC CONTROLLER-MAIN	1	CWA73C8693	O
⚠	42	REACTOR	1	G0C103Z00003	O
⚠	43	RESIDUALCURRENT-CIRCUIT BREAKER	2	K5KYYAY00003	O
⚠	44	TERMINAL BOARD ASSY (1, 2, 3)	1	CWA28K1217	O
⚠	45	TERMINAL BOARD ASSY (A, B)	1	CWA28K1238	O
⚠	46	TERMINAL BOARD ASSY (1, 2, 3, 4, 5)	1	CWA28K1328	O
⚠	47	TERMINAL BOARD ASSY (6, 7, 8, 9)	1	CWA28K1329	O
	48	HOLDER-P.S. CORD	3	CWH31103	
	49	OPERATING INSTRUCTION	1	CWF569846	

SAFETY	REF. NO.	DESCRIPTION	QTY.	WH-ADC1216G6E5	REMARK
	50	OPERATING INSTRUCTION	1	CWF569864	
	51	INSTALLATION INSTRUCTION	1	CWF616652	
	52	INSTALLATION INSTRUCTION	1	CWF616651	
	53	REMOTE CONTROL COMPLETE	1	CWA75C4522	O
	54	CABINET TOP PLATE	1	CWE031220	
	55	CABINET FRONT PLATE	1	CWE061380A	
	56	CABINET FRONT PLATE ASS'Y	1	CWE06K1114A	
	57	MAGNET CATCHER	2	CWH601009	
	58	LEVER ARM	1	CWH651115	
	59	ACCESSORY-ADJUSTABLE FEET	1	CWH82C2112	
	60	ACCESSORY CO. (DRAIN ELBOW)	1	CWG87C900	
	62	BAG	1	CWG861544	
	63	BASE BOARD-CO. (BOTTOM)	1	CWG62C1201	
	64	BASE BOARD-CO. (UPPER)	1	CWG60C1058	
	65	SHOCK ABSORBER	4	CWG713134	
	66	C.C. CASE	1	CWG580594	
	67	HINGE	3	CWH611005	
	100	FILTER COMPLETE	1	ACXB51-00080	

Note:

- All parts are supplied from PAPAMY, Malaysia (Vendor Code: 00029488) except (*).
- "O" marked parts are recommended to be kept in stock.
- (*) supplied by PCSE (Hamburg).

19.2 Outdoor Unit

19.2.1 WH-UX09FE5 WH-UX12FE5

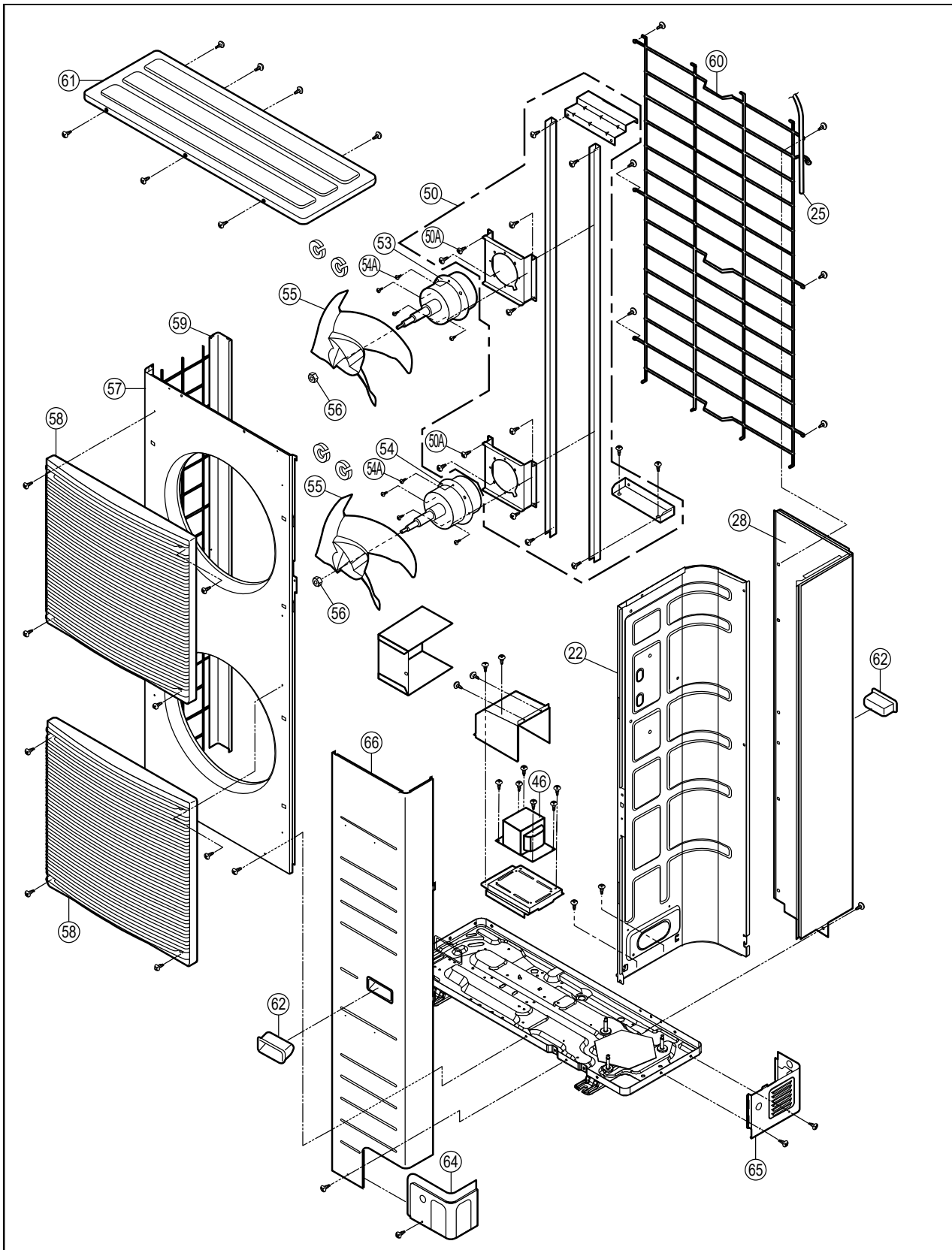

Note:

- The above exploded view is for the purpose of parts disassembly and replacement.
- The non-numbered parts are not kept as standard service parts.

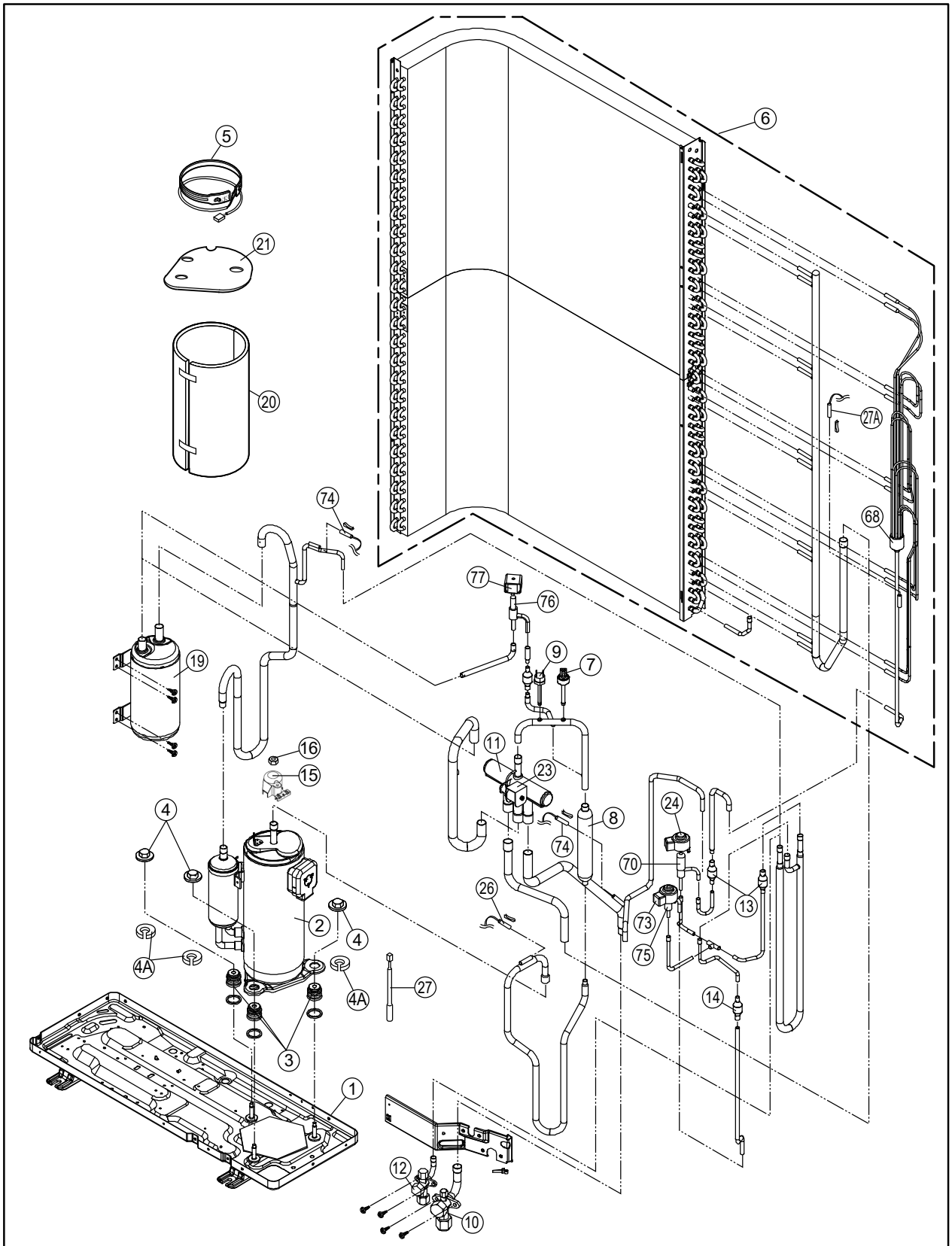

Note:

- The above exploded view is for the purpose of parts disassembly and replacement.
- The non-numbered parts are not kept as standard service parts.

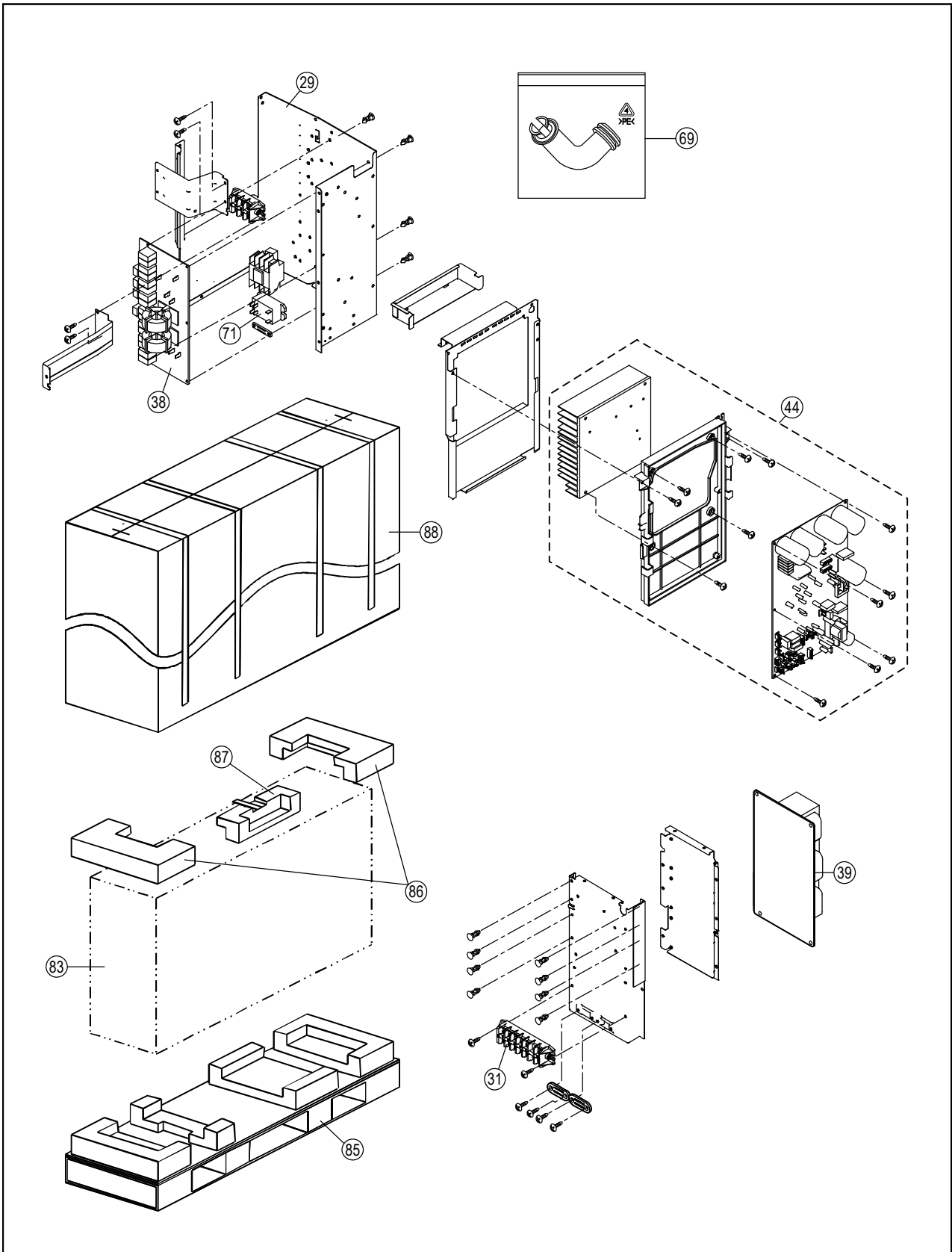

Note:

- The above exploded view is for the purpose of parts disassembly and replacement.
- The non-numbered parts are not kept as standard service parts.

<WH-UX09FE5 WH-UX12FE5>

SAFETY	REF. NO.	DESCRIPTION & NAME	QTY.	WH-UX09FE5	WH-UX12FE5	REMARK
	1	BASE PAN ASS'Y	1	CWD52K1275	←	
⚠	2	COMPRESSOR	1	5JD420XAA22	←	O
	3	BUSHING - COMPRESSOR MOUNT	3	CWH50055	←	
	4	NUT - COMPRESSOR MOUNT	3	CWH561049	←	
	4A	GASKET FOR TERMINAL COVER	3	CWB811017	←	
	5	CRANKCASE HEATER	1	CWA341053	←	
	6	CONDENSER COMPLETE	1	CWB32C3986	←	
	7	HIGH PRESSURE SENSOR	1	CWA501463	←	O
	8	DISCHARGE MUFFLER	1	CWB121014	←	
	9	PRESSURE SWITCH	1	CWA101007	←	O
	10	3-WAYS VALVE (GAS)	1	CWB011251	←	
	11	4-WAYS VALVE	1	CWB001046	←	
	12	3-WAYS VALVE	1	CWB011292	←	
	13	STRAINER	2	CWB111032	←	
	14	STRAINER	1	CWB111032	←	
	15	TERMINAL COVER	1	CWH171039A	←	
	16	NUT - TERMINAL COVER	1	CWH7080300J	←	
	19	ACCUMULATOR	1	CWB131026A	←	
	20	SOUND PROOF MATERIAL	1	CWG302265	←	
	21	SOUND PROOF MATERIAL	1	CWG302266	←	
	22	SOUND PROOF BOARD	1	CWH15K1019	←	
⚠	23	V-COIL COMPLETE (4 WAY VALVE)	1	CWA43C2169J	←	O
⚠	24	V-COIL COMPLETE (MAIN EXPANSION VALVE)	1	CWA43C2602	←	O
	25	SENSOR - COMP. (OUTLET AIR TEMP SENSOR)	1	CWA50C2730	←	O
	26	SENSOR - COMP. (DISCHARGE TEMP SENSOR)	1	CWA50C2576	←	O
	27	SENSOR - COMPLETE (COMP TEMP SENSOR)	1	CWA50C2629	←	O
	27A	SENSOR - COMP. (DEFROST TEMP SENSOR)	1	CWA50C2577	←	O
	28	CABINET REAR PLATE - COMPLETE	1	CWE02C1064	←	
	29	CONTROL BOARD CASING	1	CWH10K1049	←	
⚠	31	TERMINAL BOARD ASS'Y	1	CWA28K1213	←	O
⚠	38	ELECTRONIC CONTROLLER - (NF)	1	CWA747852	←	O
⚠	39	ELECTRONIC CONTROLLER - (CAPACITOR)	1	CWA747853	←	O
⚠	44	ELECTRONIC CONTROLLER - (MAIN)	1	CWA73C8131R	CWA73C8152R	O
⚠	46	REACTOR	1	G0C592J00006	←	O
⚠	50	FAN MOTOR BRACKET	1	CWD54K1024	←	
	50A	SCREW - FAN MOTOR BRACKET	8	CWH551040J	←	
	53	FAN MOTOR (UPPER)	1	EHDS83CAC	←	O
	54	FAN MOTOR (LOWER)	1	EHDS83DAC	←	O
	54A	SCREW - FAN MOTOR MOUNT	8	CWH551323	←	
	55	PROPELLER FAN ASSY	2	CWH00K1006	←	
	56	NUT	2	CWH561092	←	
	57	CABINET FRONT PLATE	1	CWE061098A	←	
	58	DISCHARGE GRILLE	2	CWE201073	←	
	59	CABINET SIDE PLATE ASSY	1	CWE04K1023A	←	
	60	WIRE NET	1	CWD041103A	←	
	61	CABINET TOP PLATE CO.	1	CWE03C1096	←	
	62	HANDLE	2	CWE161008	←	
	64	PIPE COVER (FRONT)	1	CWD601074A	←	
	65	PIPE COVER (BACK)	1	CWD601075A	←	
	66	CABINET FRONT PLATE CO.	1	CWE06C1091	←	
	68	TUBE ASSY (CAP. TUBE)	1	CWT07K1541	←	

SAFETY	REF. NO.	DESCRIPTION & NAME	QTY.	WH-UX09FE5	WH-UX12FE5	REMARK
	69	ACCESSORY CO. (DRAIN ELBOW)	1	CWG87C2030	←	
	70	EXPANSION VALVE (1)	1	CWB051049	←	O
	71	ELECTRO MAGNETIC SWITCH	1	K6C1AYY00003	←	O
⚠	73	V-COIL COMPLETE (CN-EV2)	1	CWA43C2335	←	O
	74	SENSOR - COMP. (BYPASS & EVA EXIT TEMP)	1	CWA50C3165	←	O
	75	EXPANSION VALVE (BYPASS)	1	CWB051029	←	O
	76	2-WAYS VALVE	1	CWB021637	←	
⚠	77	V-COIL COMPLETE (2 WAY VALVE)	1	CWA43C2607	←	O
	83	BAG	1	CWG861204	←	
	85	BASE BOARD - COMPLETE	1	CWG62C1086	←	
	86	SHOCK ABSORBER	2	CWG712852	←	
	87	SHOCK ABSORBER	1	CWG712854	←	
	88	C.C. CASE	1	CWG568054	←	

Note:

- All parts are supplied from PAPAMY, Malaysia (Vendor Code: 00029488).
- "O" marked parts are recommended to be kept in stock.

19.2.2 WH-UD12FE5 WH-UD16FE5

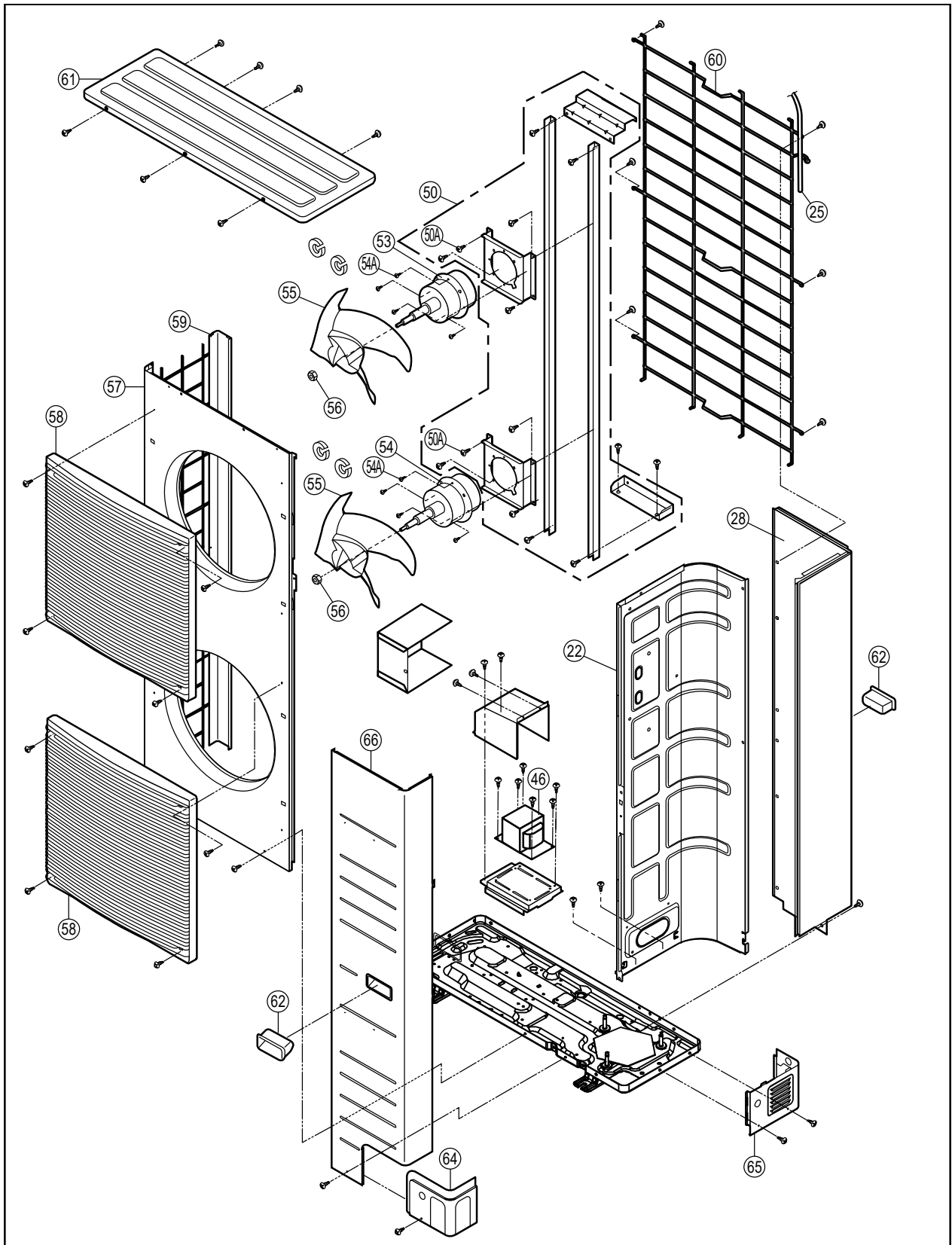

Note:

- The above exploded view is for the purpose of parts disassembly and replacement.
- The non-numbered parts are not kept as standard service parts.

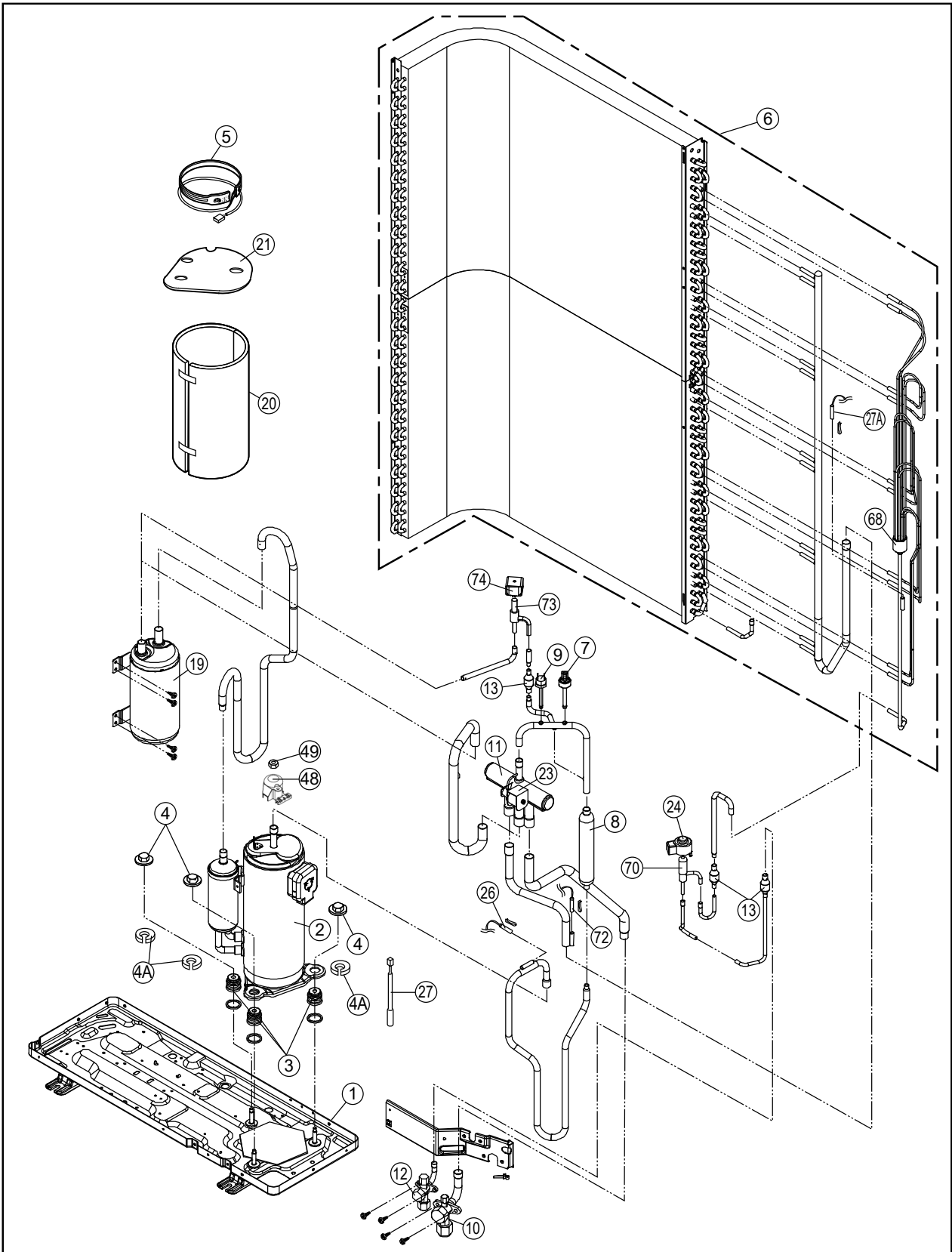

Note:

- The above exploded view is for the purpose of parts disassembly and replacement.
- The non-numbered parts are not kept as standard service parts.

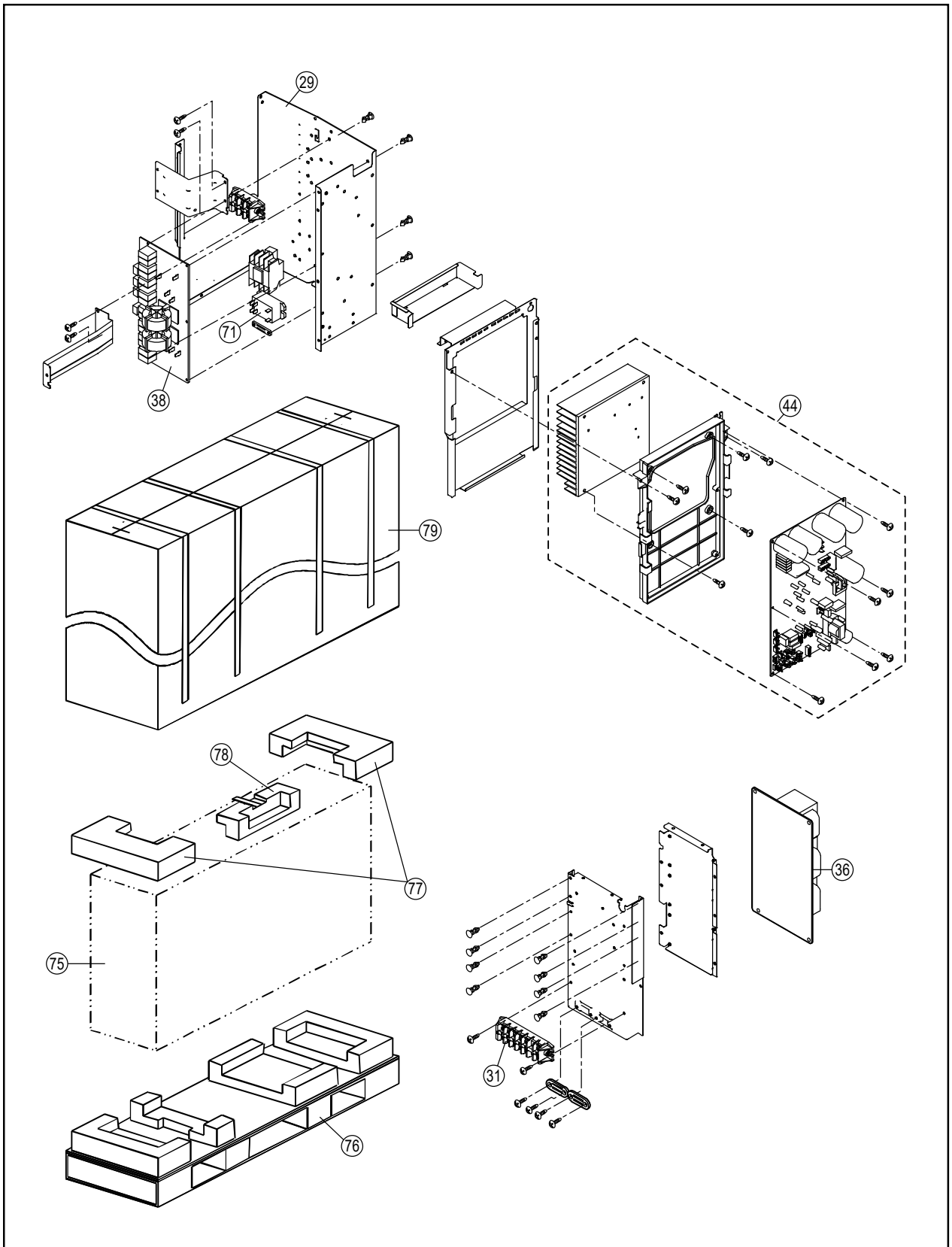

Note:

- The above exploded view is for the purpose of parts disassembly and replacement.
- The non-numbered parts are not kept as standard service parts.

<WH-UD12FE5 WH-UD16FE5>

SAFETY	REF. NO.	DESCRIPTION & NAME	QTY.	WH-UD12FE5	WH-UD16FE5	REMARK
	1	BASE PAN ASS'Y	1	CWD52K1275	←	
⚠	2	COMPRESSOR	1	5JD420XAA22	←	O
	3	BUSHING - COMPRESSOR MOUNT	3	CWH50055	←	
	4	NUT - COMPRESSOR MOUNT	3	CWH561049	←	
	4A	GASKET FOR TERMINAL COVER	3	CWB811017	←	
	5	CRANKCASE HEATER	1	CWA341053	←	
	6	CONDENSER COMPLETE	1	CWB32C3986	←	
	7	HIGH PRESSURE SENSOR	1	CWA501463	←	
	8	DISCHARGE MUFFLER	1	CWB121014	←	
	9	PRESSURE SWITCH	1	CWA101013	←	O
	10	3-WAYS VALVE (GAS)	1	CWB011251	←	O
	11	4-WAYS VALVE	1	CWB001046	←	O
	12	3-WAYS VALVE (LIQUID)	1	CWB011292	←	O
	13	STRAINER	3	CWB111032	←	
	19	ACCUMULATOR	1	CWB131026A	←	
	20	SOUND PROOF MATERIAL	1	CWG302881	←	
	21	SOUND PROOF MATERIAL	1	CWG302266	←	
	22	SOUND PROOF BOARD	1	CWH15K1019	←	
⚠	23	V-COIL COMPLETE (FOR 4 WAY VALVE)	1	CWA43C2169J	←	O
⚠	24	V-COIL COMPLETE (FOR EXPANSION VALVE)	1	CWA43C2602	←	O
	25	SENSOR - COMP. (OUTDOOR AIR & PIPE TEMP CN-TH1)	1	CWA50C2730	←	O
	26	SENSOR - COMP. (DISCHARGE TEMP CN-DIS)	1	CWA50C2576	←	O
	27	SENSOR - COMP. (COMP TEMP CN-TANK)	1	CWA50C2629	←	O
	27A	SENSOR - COMP. (DEFROST TEMP CN-TH2)	1	CWA50C2577	←	O
	28	CABINET REAR PLATE - COMPLETE	1	CWE02C1059	←	
	29	CONTROL BOARD CASING	1	CWH10K1049	←	
⚠	31	TERMINAL BOARD ASS'Y	1	CWA28K1213	←	O
⚠	36	ELECTRONIC CONTROLLER - CAPACITOR	1	CWA746169	←	O
⚠	38	ELECTRONIC CONTROLLER - NF	1	CWA747852	←	O
⚠	44	ELECTRONIC CONTROLLER - MAIN	1	CWA73C8450R	CWA73C8452R	O
⚠	46	REACTOR	1	G0C592J00005	←	O
	48	TERMINAL COVER	1	CWH171039A	←	
	49	NUT - TERMINAL COVER	1	CWH7080300J	←	
⚠	50	FAN MOTOR BRACKET	1	CWD54K1084	←	
	50A	SCREW - FAN MOTOR BRACKET	8	CWH551040J	←	
	53	FAN MOTOR (UPPER)	1	EHDS83CAC	←	O
	54	FAN MOTOR (LOWER)	1	EHDS83DAC	←	O
	54A	SCREW - FAN MOTOR MOUNT	8	CWH551323	←	
	55	PROPELLER FAN ASSY	2	CWH00K1006	←	
	56	NUT	2	CWH561092	←	
	57	CABINET FRONT PLATE	1	CWE061098A	←	
	58	DISCHARGE GRILLE	2	CWE201073	←	
	59	CABINET SIDE PLATE ASSY	1	CWE04K1023A	←	
	60	WIRE NET	1	CWD041103A	←	
	61	CABINET TOP PLATE CO.	1	CWE03C1096	←	
	62	HANDLE	2	CWE161008	←	
	64	PIPE COVER (FRONT)	1	CWD601074A	←	
	65	PIPE COVER (BACK)	1	CWD601075A	←	
	66	CABINET FRONT PLATE CO.	1	CWE06C1091	←	
	68	TUBE ASSY (CAP. TUBE)	1	CWT07K1606	←	

SAFETY	REF. NO.	DESCRIPTION & NAME	QTY.	WH-UD12FE5	WH-UD16FE5	REMARK
	70	EXPANSION VALVE	1	CWB051049	←	O
	71	ELECTRO MAGNETIC SWITCH	1	K6C1AYY00003	←	O
	72	SENSOR COMPLETE (EVA EXIT CN-TH3)	1	CWA50C3204	←	O
	73	2-WAYS VALVE	1	CWB021637	←	O
	74	V-COIL COMPLETE (FOR 2 WAY VALVE)	1	CWA43C2607	←	O
	75	BAG	1	CWG861204	←	
	76	BASE BOARD - COMPLETE	1	CWG62C1086	←	
	77	SHOCK ABSORBER	2	CWG712852	←	
	78	SHOCK ABSORBER	1	CWG712854	←	
	79	C.C. CASE	1	CWG568054	←	

Note:

- All parts are supplied from PAPAMY, Malaysia (Vendor Code: 00029488).
- "O" marked parts are recommended to be kept in stock.